



# **Valve Data Manual**

**OCR- Edition 23  
1981**

for models

**CT 160 · VT 160**

**VCM mk 1 · VCM mk 2 · VCM mk 3 · VCM mk 4 · VCM 163**

**INTENTIONALLY LEFT BLANK**

## **AVO Valve Data Manual 23<sup>rd</sup> edition, OCR version**

This is an OCR version of the 23<sup>rd</sup> edition of the AVO Valve Data Manual. Much effort has been put into making this manual a reality and I hope it will be useful for everyone.

This manual is probably still as full of errors as the original manual but some obvious errors have been corrected, like data showing up in the wrong column or row, but most of the original data is intact. A lot of effort has been put into proof reading the OCR-version by myself but also by my friend Euan MacKenzie. Valve data which had brackets surrounding two or more rows have been converted into separate rows. I will not write more on this as I am sure to invoke Murphy's Law or Muphry's Law if I do!

I have centered the tables on each page so that it will be easy to read on a computer, it is still possible to print the VDM but there is no margin adjustment for even and odd pages. I've also made every second row grey in the tables so it will be easier to follow them while reading the data.

Megger has kindly let me publish this OCR version of the manual. This manual therefore contains the text "© Copyright Megger Limited" on all pages and also the following copyright notice by Megger:

"© Copyright Megger. Megger retains copyright in all text, still images, moving images and sound recordings ('Marketing Assets') where they were originally created by AVO, Megger or other legacy or associated companies of Megger Limited. Reproduction of the Marketing Assets must be accompanied by the caption "Copyright Megger Limited". These conditions must also be agreed by the third party to whom this copyright information may be passed.

Megger reserves the right to revoke this licence should the Marketing Assets be used for a purpose which at its absolute discretion Megger deems unacceptable."

You are therefore bound by the usual copyright rules and are not allowed to reprint or sell this manual in any form whatsoever.

This manual in its PDF-file format is fully searchable in all text and data fields except for in the pictures.

Martin Forsberg, Sweden, Monday, February 23, 2015 - 18:03:27

**INTENTIONALLY LEFT BLANK**



# **Valve Data Manual**

**OCR-Edition 23  
1981**

for models

**CT 160 · VT 160**

**VCM mk 1 · VCM mk 2 · VCM mk 3 · VCM mk 4 · VCM 163**

## ABBREVIATIONS

CCR	Cold Cathode Rectifier
D	Diode
DD	Double Diode
DDD	Triple Diode
DDDD	Quadruple Diode
DT	Diode Triode
DDT	Double Diode Triode
DP	Diode Pentode
DDP	Double Diode Pentode
gm	Mutual Conductance in milliamps per volt
H	Heptode or Hexode
la	Anode current in milliamps
N	Nonode
O	Octode
P	Pentode or Tetrode
PP	Double Pentode or Double Tetrode
T	Triode
TH	Triode Heptode or Triode Hexode
THY	Thyratron
TI	Tuning Indicator
TP	Triode Pentode
TT	Double Triode
TTT	Triple Triode
R	Half-wave rectifier
RR	Full-wave rectifier
Ra	Anode Circuit resistance
Va	Anode voltage
Vg1	Control grid voltage
Vg2	Screen grid voltage
Vh	Heater voltage
VCM	Valve Characteristic Meter
X, Y, Z	Are positions on the Pin Selector switches on the VCM 163

# SYMBOLS

## \* INTERNAL CONNECTION

Among Selector Switch settings, this indicates that the valve pin is connected inside the valve to an electrode for the purpose of improving mechanical rigidity. As the internal connection may be to a different electrode for any given valve type, it is essential that this pin be left unconnected to the valve tester (Selector Switch to 0). If it is required to know which electrode is internally connected to the asterisked pin, this may be done with an ohmmeter on a sufficiently low range to discriminate between heater resistance and a direct connection.

## † TRIPLE DIODE TESTING

Among Selector Switch settings, this indicates the pin connecting the third diode (d'''). With the earlier generations of testers (all other than VCM 163) this requires a special testing procedure for d'''. Please refer to the Operating Instructions for the tester concerned.

## ‡ EXTERNAL ANODE LOAD

A dagger appearing in the gm data column indicates that the figure given is the value of the external anode load (Ra) to be inserted for the test. Please see notes on Testing Tuning Indicators, Cold Cathode Rectifiers, Gas-filled Rectifiers and Thyratrons.

## () HIGH CURRENT HEATERS

Brackets around heater voltage, e.g. (5), indicate that a tester voltage setting higher than that specified by the valve manufacturer should be used to compensate for voltage drop at the valve base, occurring in the case of high current heaters.

## § SECONDARY EMISSION

This symbol against a type number indicates a valve susceptible to secondary emission (back emission) from the anode. For these valves two alternative sets of figures are given.

## Φ GRID CURRENT ERRORS (VCM1 and VCM2 only)

Next to a type number, this indicates a valve calling for  $V_{g^1j}$  of less than 1 V and which is susceptible to grid current. This current may increase the grid bias voltage, giving rise to unexpectedly low mutual conductance readings. For these valves, two alternative sets of figures are given which only need be used if testing with a VCM1 or VCM2.

## Δ VALVES OF LOW ANODE RESISTANCE (all testers except VCM 163)

Next to type number, this indicates a valve which is likely to give Ia and gm readings considerably different from the valve makers data. With the earlier generations of AVO valve testers this effect was due to the internal anode resistance of the valve (ra) being of a very low value, approaching that of the anode current measuring circuit of the tester (approx. 200Ω). To overcome this limitation, the readings of Ia and gm obtained should be compared with those of a known good valve, Ia and gm values quoted are for use with the VCM 163 Tester only.

## □ INTER-ELECTRODE TESTS AT LOW VOLTAGE ONLY (all testers except VCM 163)

Next to a type number, this indicates a specialised valve type (thyatron, close-spaced VHF triode etc.) whose manufacturer has placed a very low limit on the inter-electrode voltage ratings. These restrictions apply whether the valve is hot or cold. The earlier generations of AVO valve testers should not be used for inter-electrode insulation testing on these few types, because the test voltage used is 150V (peak). The limitation does not apply to the tester VCM 163 where the test voltage used is 50V d.c.

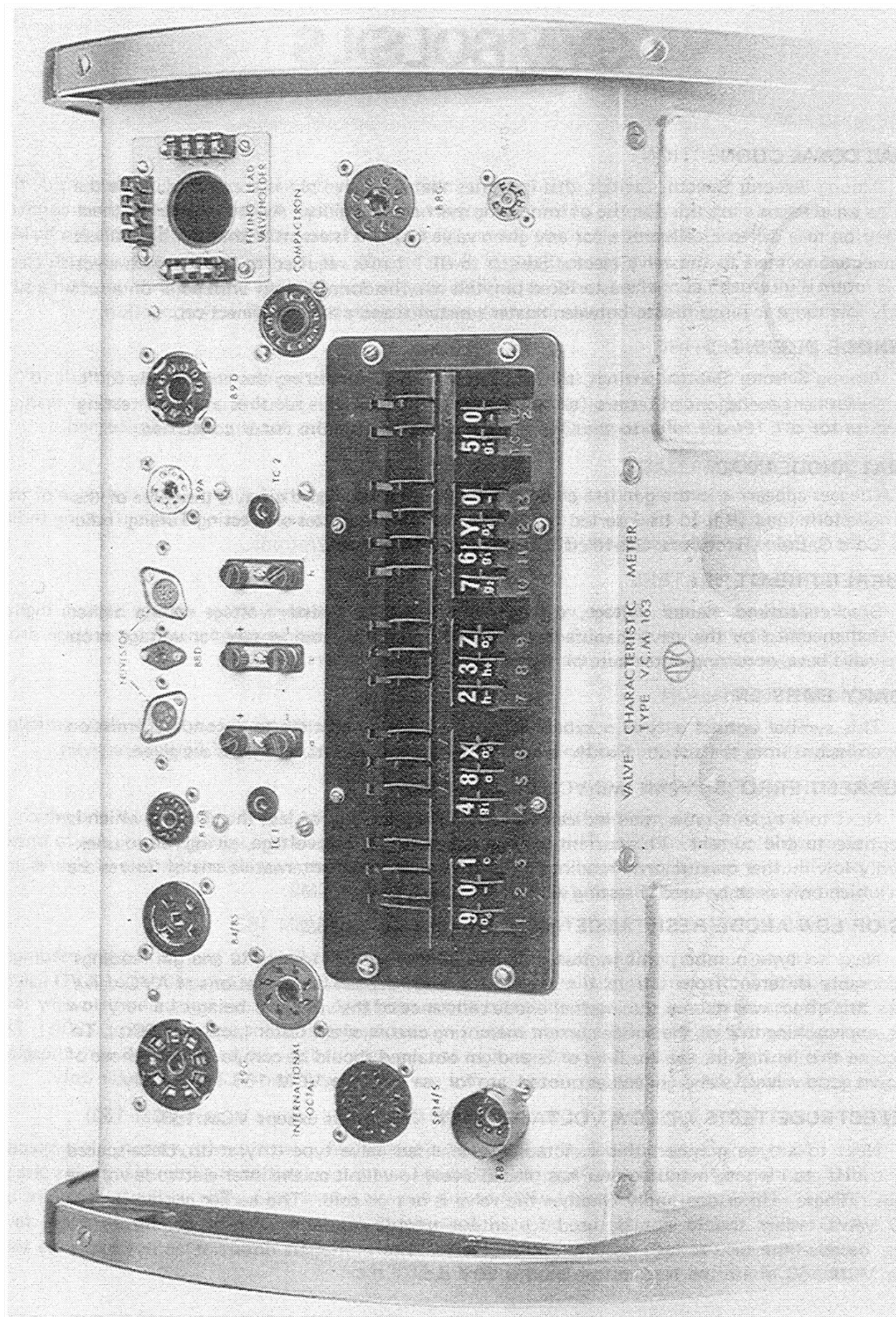

The Valve Socket Panel of the AVO VCM163 Valve Characteristic Meter



# CONTENTS

Abbreviations	ii
Symbols	iii
Warnings	v
Using the AVO Valve Data Manual	vi
Setting up tester from valve manufacturers' data	ix
Standard numbering of valve pins	x
Finding pin connections from AVO Manual	xi
AVO socket adaptors	xii
Test Data for Receiving and Small Transmitting Valves	1
Test Data for High Voltage Rectifiers — Appendix 1	159
Test Data for CV Valves	160
Equivalentents — Commercial	162
Equivalentents — Service types to commercial	222
Equivalentents — American Army VT types	241
Equivalentents — British Post Office types	243
Equivalentents — BVA Wartime Utility types	244

---

# WARNINGS

## USE OPERATING INSTRUCTIONS

This book does not replace Operating Instructions supplied with the various AVO Valve Tester models.

## ELECTRIC SHOCK

Users of AVO Valve Testers are warned that voltages of up to 450V may be present on valve sockets and link terminals (where provided) for external component connections.

## CONSTANT VOLTAGE TRANSFORMERS

In the interests of accuracy, it is recommended that AVO Valve Testers should NOT be powered from a constant voltage transformer, unless it is known that the 3rd and 5th harmonic content is of negligible proportion.

## DAMAGE TO VALVES

While every care has been taken in the preparation of this manual, the publishers cannot accept any responsibility for damage caused to any valve under test, or to the instrument, resulting from incorrect information.

## TRADE MARKS

The Trade Marks AVO and AVOMETER are the exclusive property of AVO Limited

© AVO Limited 1981

# USING THE AVO VALVE MANUAL

## USE WITH AVO VALVE TESTERS

This manual is published primarily as an aid to users of AVO valve testers in setting up their instrument for each valve type. The operating procedure and some instrument limitations vary according to the tester model concerned and users should obtain this class of information from the Operating Instructions supplied with the tester.

The AVO instruments covered by this manual are:

VCM 163	Valve Characteristic Meter
VCM mk 1	Valve Characteristic Meter
VCM mk 2	Valve Characteristic Meter
VCM mk 3	Valve Characteristic Meter
VCM mk 4	Valve Characteristic Meter
VT 160	Valve Tester, Commercial Version
CT 160	Valve Tester, Services Version

## USE FOR INDEPENDENT REFERENCE

The manual is also a useful source of basic valve data, indexed by type number only, without the need to know the valve manufacturer. Valve characteristics are given directly, in tabular form and pin connections may be obtained by decoding the selector switch settings for VCM 163 (p. xi).

## MULTIPLE VALVES

For multiple valves (e.g. triode-pentodes), two lines of characteristic data are given in this manual. The section with the fewer electrodes is given on the top line (e.g. triode, in a triode-pentode). This is usually obvious from the absence or presence of a  $V_{g2}$  value in the tables. Where the two sections have identical characteristics (e.g. a double triode) only one line is given. For quadruple diodes (e.g. 6JU8) the anodes of D1 and D3 are coupled internally to the cathodes of D2 and D4. In these cases, two lines of pin Selector Switch settings are given in order that each diode pair may be tested separately.

#### TYPE VARIANTS

Usually indicated by suffix letters added by the manufacturer to the basic type numbers;

Example 1	Basic type	6L6
	Variants	6L6A, 6L6B, 6L6G, 6L6GT, 6L6GTA

In this example, the variations concern the glass bulb or base and do not affect the characteristics. Therefore only one entry is given in this manual, under basic type 6L6, which is equally valid for testing all the variants shown in the example.

Example 2	Basic type	PL8 1
	Variant	PL8 1A

In some cases the variant does have different characteristics from the basic type and in these cases the manual gives separate entries.

#### FLYING LEAD VALVES

AVO Valve Testers VCM 163, VCM 4, CT 160 and VT 160 have special connecting sockets for flying leads valves. In other tester models valves with solder-in wire leads, in place of the normal plug-in type of base, may be tested by inserting the wires carefully into a suitable valve holder on the tester. As each flying lead valve is usually a variant of a normal based type, it is best to use the socket appropriate to the based type.

In the case of Brimar flying lead valves, these have prefix letters *F*, *FF*, *SF*, *SX*, or *XF* before the basic type number, e.g. *F/6064*. The AVO Valve Manual gives the test data under the basic type number 6064 but not under the flying lead variant *F/6064*.

#### TUNING INDICATORS

Special procedures are required for testing cathode ray tuning indicators, full details of which are given in the Operating Instruction book with each tester. Testers type VCM 1 and VCM 2 are not suitable for testing tuning indicators.

The tester screen-grid switch is used to connect the target supply and the voltage required is given in the  $V_{g2}$  column of this manual. An external anode load resistor is required and this may be connected between the Anode Link terminals on the tester. The value of the resistor required is given in the gm data column, keyed with a dagger symbol †. At the approximate bias given in the  $V_{g1}$  column, the triode section should be at cut-off and the display showing the minimum area.

On reducing the grid bias to zero, the illuminated area should increase to maximum and the anode current should be approximately that given in the  $I_a$  column.

For dual sensitivity indicators, two lines of data are given, the upper line relating to the more sensitive indication.

#### THYRATRONS

Special procedures are required for testing thyratrons, full details of which are given in the Operating Instructions book with each tester. Testers VCM 1 and VCM 2 are not suitable for the testing of thyratrons.

The applied anode voltage for testing thyratrons is given in the  $V_a$  column of this manual in the usual way. The resistance figure given in the gm column is the value of external load to be connected between the Anode Link terminals on the tester. With  $I_a$  meter on the highest range,  $V_{g1}$  is set to maximum and then reduced until the valve strikes. The value of current flow to be expected is given in the  $I_a$  column of this manual.

#### COLD CATHODE and GAS FILLED RECTIFIERS

Testing valves of these types requires the external connection of a suitable range limiting resistor between the Anode Link terminals of the AVO tester, in order to protect the valve from damage. The value of resistor to use is given in the gm column of this manual. Testers VCM 1 and VCM 2 are not suitable for testing these rectifiers.

#### HIGH VOLTAGE RECTIFIERS

Test data for high voltage rectifiers requires a different format and special test procedure. The information on testing these types appears separately in Appendix 1 in this manual.

#### VOLTAGE STABILISERS

Voltage stabiliser valves (e.g. OA2, QS75/20, STV108-30, VR75/30) are not included in this manual because they cannot be fully tested on AVO Valve Characteristic Meters.

# SETTING UP TESTER

## FROM VALVE MANUFACTURER'S DATA

This Valve Data Manual lists over 7,900 different types but should a valve be encountered which is not included, AVO testers may be set up from data supplied by the valve manufacturer.

### PROCEDURE

- 1 Look up the valve in the manufacturer's data and refer to the base diagram.
- 2 Set the Selector Switch for Pin 1 (on the left hand end of the barrel switch assembly on the AVO valve tester) to the electrode given by the valve maker. The roller selectors are engraved with the standard electrode letter symbols, as well as switch position code numbers used in this manual.
- 3 Repeat for remaining pin connections
- 4 Set electrode supplies from valve manufacturer's "Characteristics" data. Do not use figures given under headings of "Maximum Ratings" or "Typical Operation".
- 5 Plug valve into appropriate socket and proceed with normal test in accordance with the Operating Instructions for the tester concerned.

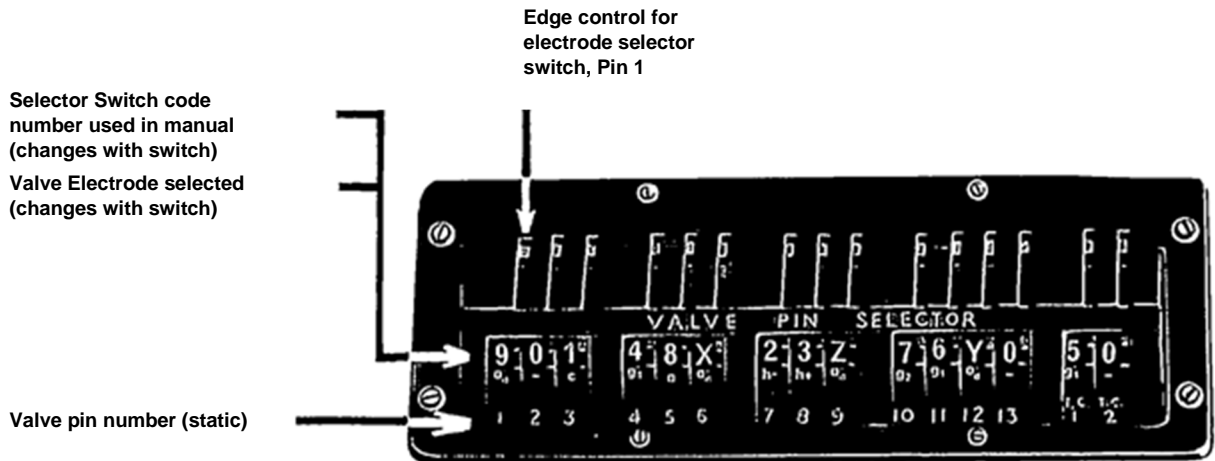

Top view of the barrel switch assembly on an AVO VCM 163. Other tester models are similar, but some have fewer switch rollers

**STANDARD NUMBERING OF VALVE PINS**  
(viewed from underside of socket)

X

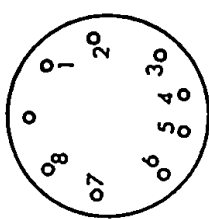

British Nine Pin (B9)

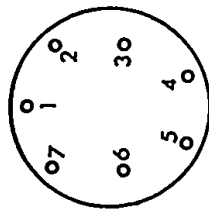

British Seven Pin (B7)

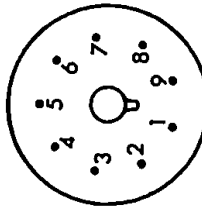

B9G

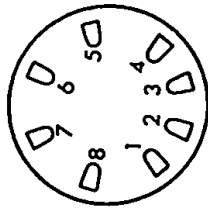

'p' Type Base (8 SC)

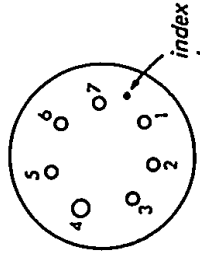

B7A

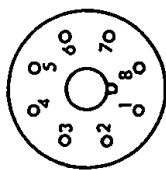

International Octal (A08)

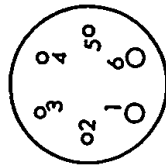

American Six Pin (UX6)

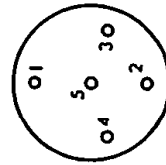

British 4/5 Pin (B5 & 4)

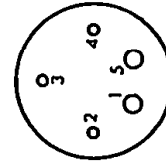

American 5 pin (UX5)

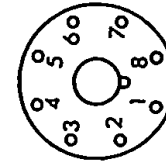

Mazda Octal (M08)

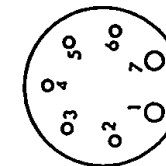

American Small 7 Pin (SM7)

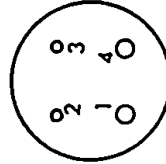

American Four Pin (UX4)

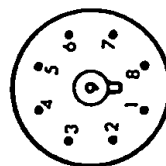

American Octal (B8B or B8G)



Sub Miniature 8 Pin (B8D)

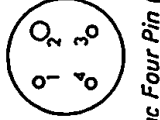

Hivac Four Pin (SM4)

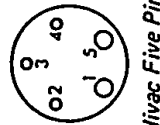

Hivac Five Pin (SM5)

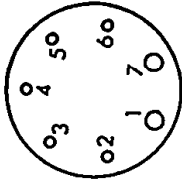

American 7 Pin (UX7)



B9D

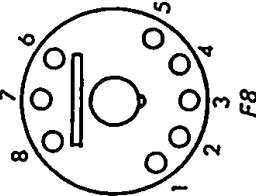

5AA & 7AA (Acorn Valve)

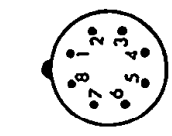

B8A

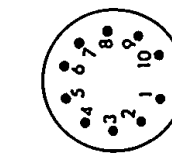

B10B

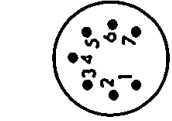

B7G



B9A

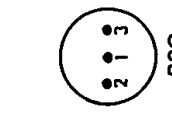

B3G



Nuvistor (NV5 & NV7)

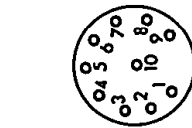

A10

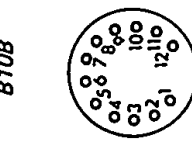

A12

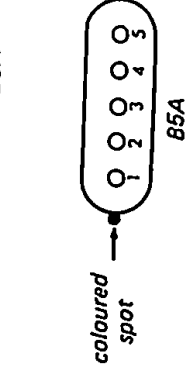

B5A



B5B

NOTE: This is not a diagram of the socket panel of any AVO valve tester

## FINDING PIN CONNECTIONS FROM AVO VALVE DATA MANUAL

When using the AVO Valve Data Manual for independent reference in servicing work, the valve characteristics information is read out directly, but the valve pin connections need decoding.

This is easily done by taking the 'Selector Switch' and 'Top Cap' code numbers given in the VCM 163 columns of the AVO Valve Data Manual and decoding them by reference to the following tables and to the standard valve pin numbering diagrams on the facing page.

**PIN DECODING TABLES**

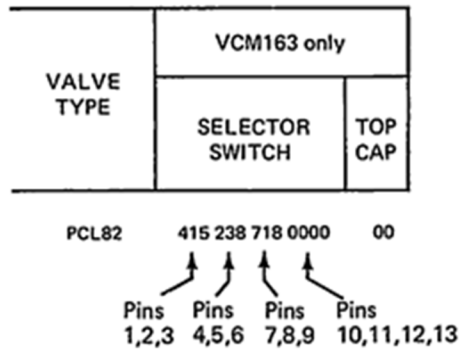

Electrode Selector Switch Code Number in Valve Manual	Electrode Symbol	Electrode
0	-	None
1	C	Cathode
2	h-	Heater
3	h+	Heater
4	g1'	Control grid
5	g1''	Control grid of second section
6	g1'''	Control grid of third section
7	g2	Screen grid
8	a	Anode
9	ad'	First Diode anode
X	ad''	Second Diode anode
Y	ad'''	Third Diode anode
Z	ad''''	Fourth Diode anode

**EXAMPLE**

For PCL82, Pin 1 is shown in the AVO Manual as Electrode Code 4. Decoding table shows Code Number 4 always represents Control Grid. Hence Pin 1 is Control Grid. The position of Pin 1 is found from the Standard Pin Numbering Diagram.

## VALVE SOCKET ADAPTORS

If the required valve socket is not already fitted to your AVO valve tester, one of the socket adaptors may provide a solution.

The following adaptors were available, at the time of going to press, from:

AVO Ltd,  
Archcliffe Road,  
Dover, Kent. CT17 9EN

Telephone: Dover (0304) 202620

### ADAPTORS

VCM 163 ONLY			VCM 3 VT160	VCM 4 CT 160	VCM 1	VCM 2		
Adaptor No	Socket type	Plugs in to	Adaptor No	Socket type	Plugs in to	Adaptor No	Socket type	Plugs in to
2	B9G	A08	5	Fit your own socket	A08	1	B7G and B8A	
3	B8B (loctal)	A08	6	SM7 (to fit SA7 base)	A08		(Miniature and Rimlock)	A08
4	B3G	A08	9	B7A	A08	2	B9G	A08
5	Fit your own socket	A08	11	B5A (5 flying leads)	A08	3	B8B (Loctal)	A08
6	SM7 (fits SA7 base)	A08				4	B3G	A08
9	B7A	A08				5	Fit your own socket	A08
17	UX6 (American 6-pin)	SP14				6	SM7 (fits SA7 base)	A08
18	UX7 (American 7-pin)	SP14				9	B7A	A08
19	M08 (Mazda octal)	SP14				11	B5A (5 flying leads)	A08
20	B7 (British 7-pin)	SP14						



SPEC.	VALVE TYPE NUMBER	PIN CONNECTIONS				CHARACTERISTICS						BASE	VALVE CLASS
		VCM163 Tester Only		CT160, VT160, VCM Mk 1,2,3,4		Vh	Vg1	Va	Vg2	la	gm mA/V		
		SELECTOR SWITCH	TOP CAP	SELECTOR SWITCH	TOP CAP	V	V	V	V	mA	†Ra MΩ		
	0Z4	008 080 101 0000	00	007 060 010				250		58	†3k	AO8	CCR
	00	384 200 000 0000	00	364 200 000		5	0	40		1.0	0.66	UX4	T
	00A	384 200 000 0000	00	364 200 000		5	0	40		1.5	0.66	UX4	T
	01	384 200 000 0000	00	364 200 000		5	4.5	90		2.5		UX4	T
	01A	384 200 000 0000	00	364 200 000		5	9	150		3	0.8	UX4	T
	01AA	384 200 000 0000	00	364 200 000		5	4.5	90		3.2	0.9	UX4	T
	01B	384 200 000 0000	00	364 200 000		5	4.5	90		2.5	0.72	UX4	T
	06F90	873 420 000 0000	00	653 420 000		0.6	1.1	20	20	.05	0.1	B5A	P
	054V	842 310 000 0000	00	642 310 000		4		100			4	B5	T
	084	842 300 000 0000	00	642 300 000		4	2.0	150		4.0	1.4	B4	T
	1	291 300 000 0000	00	281 300 000		6.3				60		UX4	R
	1A3	291 009 300 0000	00	281 008 300		1.4						B7G	D
	1A4	387 200 000 0000	40	365 200 000	G1	2	3	150	75	2.2	0.6	UX4	P
	1A4E	387 200 000 0000	40	365 200 000	G1	2	3	150	75	2.2	0.6	UX4	P
	1A4P	387 200 000 0000	40	365 200 000	G1	2	3	90	75	2.2	0.7	UX4	P
	1A4T	287 300 000 0000	40	265 300 000	G1	2	3	150	75	2.2	0.6	UX4	PP
	1A5	038 740 200 0000	00	036 540 200		1.4	4.5	90	90	4	0.85	AO8	P
	1A6	288 473 000 0000	40	266 453 000	G1	2	0	150	75	3	0.4	UX6	P
	1A7	9X2 300 000 0000	00	892 300 000		4				60		B4	RR
	1A7	028 748 300 0000	40	026 546 300	G1	1.4	0	90	45	0.6	0.25	AO8	H
	1A8	328 748 290 0000	40	327 546 280	G1	1.4		90	90	1.2	0.7	AO8	DTP
	1AB5	387 004 220 0000	00	365 004 220		1.2	1.5	150	150	6.8	1.35	B8B	P
	1AB6	287 481 300 0000	00	265 461 300		1.4	4.1	60	60	1.65	0.1	B7G	H
	1AC5	040 230 870 0000	00	*4* 23* 650		1.2	4.5	60	60	2.0	0.75	B8D	P
	1AC6	288 484 300 0000	00	266 464 300		1.4	4.0	60		4	2.2	B7G	H
	1AD2	200 000 000 0030	90	-		1.25				30		A12	R
	1AD4	872 430 000 0000	00	652 430 000		1.2	1.6	90	90	5.7	2.3	B5A	P
	1AD5	040 230 870 0000	00	*4* 23* 650		1.2	3.0	60	60	1.85	0.73	B8D	P
	1AE4	287 024 300 0000	00	265 024 300		1.2	0	90	90	3.5	1.55	B7G	P
	1AE5	842 473 000 0000	00	642 453 000		1.2		40	40	0.9	0.2	B5A	P
	1AF4	287 024 300 0000	00	265 024 300		1.4	0	90	90	1.65	0.95	B7G	P
	1AF5	209 784 300 0000	00	208 564 300		1.4	0	90	90	1.1	0.6	B7G	DP
	1AF33	209 784 300 0000	00	208 564 300		1.4		60	60	1.6	0.5	B7G	DP
	1AF34	209 784 300 0000	00	208 564 300		1.2		60	60	1.6	0.5	B7G	DP
	1AG4	873 420 000 0000	00	653 420 000		1.2	3.6	40	50	2.4	1	B5A	P
	1AG5	879 243 000 0000	00	658 243 000		1.2	2	40	40	0.2	0.2	B5A	DP
	1AH4	872 473 000 0000	00	652 453 000		1.2		40	40	0.7	0.7	B5A	P
	1AH5	209 784 300 0000	00	208 564 300		1.4	1.5	60	60	0.17	0.17	B7G	DP
	1AJ4	287 124 300 0000	00	265 124 300		1.4	0.8	75	75	1.4	0.65	B7G	P
	1AJ5	879 243 000 0000	00	658 243 000		1.2		40	40	1	0.4	B5A	DP
	1AK4	872 430 000 0000	00	652 430 000		1.2		40	40	0.7	0.7	B5A	P
	1AL4	387 004 020 0000	00	365 004 020		1.4	4.5	90	90	4	0.8	B8B	P
	1AM4	287 024 300 0000	00	265 024 300		1.4		90	60	2.4	0.3	B7G	P
	1AN5	287 224 300 0000	00	265 224 300		1.4	0	60	60	1.0	0.7	B7G	P
	1AQ5	288 424 300 0000	00	266 424 300		1.4		90	40			B7G	H
	1AR5	209 784 300 0000	00	208 564 300		1.4		60	60	0.9	0.5	B7G	DP
	1AS4	287 024 300 0000	00	265 024 300		1.4	0	90	90	1.6	0.85	B7G	P
	1AS5	287 904 300 0000	00	265 804 300		1.4		60	60	0.9	0.5	B7G	DP
	1AU3	030 000 200 0000	90	030 000 200	D1	1.2						AO8	D
	1AX2	230 232 032 0000	00	230 232 032	D1	1.4						B9A	D
	1AY2	230 000 000 0000	90	020 000 300	D1	1.25						B3G	D
	1B1P	209 784 300 0000	00	208 564 300		1.2	0	60	40	1.0	0.25	B7G	P
	1B3	020 000 300 0000	90	020 000 300	D1	1.2						AO8	D
	1B4	387 200 000 0000	40	365 200 000	G1	2	3	200	60	1.7	0.6	UX4	P
	1B4P	387 200 000 0000	40	365 200 000	G1	2	3	90	75	1.6	0.6	UX4	P

SPEC.	VALVE TYPE NUMBER	PIN CONNECTIONS				CHARACTERISTICS						BASE	VALVE CLASS
		VCM163 Tester Only		CT160, VT160, VCM Mk 1,2,3,4		Vh	Vg1	Va	Vg2	la	gm mA/V		
		SELECTOR SWITCH	TOP CAP	SELECTOR SWITCH	TOP CAP	V	V	V	V	mA	†Ra MΩ		
	1B4T(T)	287 300 000 0000	40	265 300 000	G1	2	3	150	75	1.7	0.6	UX4	P
	1B5	289 X43 000 0000	00	268 943 000		2	3	150		0.8	0.57	UX6	DDT
	1B5L	389 X42 000 0000	00	368 942 000		2	3	100		0.8	0.5	UX6	DDT
	1B6	287 408 300 0000	00	265 406 300		1.4	1.5	90	75	1.5	0.75	B7G	P
	1B7	028 748 300 0000	40	026 546 300	G1	1.4	0	90	50	1.5	0.8	AO8	H
	1B8	038 748 290 0000	40	037 546 280	G1	1.4	6	90		0.1	0.3	AO8	DTP
	1B8	038 758 290 0000	40	037 546 280	G1	1.4	6	90	90	6.3	1.1	AO8	DTP
	1BC2	200 030 000 0000	90	200 030 000	D1	1.25		100		10.0		B9A	D
	1BH2	200 030 000 0000	90	200 030 000	D1	1.25						B9A	D
	1BK2	200 030 000 0000	90	200 030 000	D1	1.4						B9A	D
	1BY2	110 011 010 0110	00	-	D1	1.25				7.0		A12	D
	1C	29X 300 000 0000	00	289 300 000		6						UX4	DD
	1C1	288 424 300 0000	00	266 424 300		1.4	4	75		4.5	1.2	B7G	H
	1C3	288 484 300 0000	00	266 464 300		1.4		60		3		UX4	P
	1C4	387 200 000 0000	40	365 200 000	G1	2	0	150	75	2.5	1	AO8	P
	1C5	038 740 200 0000	00	036 540 200		1.4	7.5	90	90	7.5	1.5	AO8	P
	1C6	388 472 000 0000	40	366 452 000	G1	2	0	150	75		1	UX6	H
	1C7	028 748 300 0000	40	026 546 300	G1	2	0	150	75		1	AO8	H
	1C8	240 238 740 0000	00	240 236 540		1.2	0	30	30	0.3		B8D	H
	1C91	824 300 000 0000	00	624 300 000		1.2	2.5	150		7		B5A	T
	1C91	028 448 300 0000	00	026 447 300		1.2	2.5	125		7		AO8	TT
	1D3	402 308 080 0000	00	402 306 060		1.2	5	90		12.5	3.4	B8A	T
	1D4	284 730 000 0000	00	264 530 000		2	6	150	150	9.5	2.4	UX5	P
	1D5	902 310 000 0000	00	802 310 000		40				120		B5	R
	1D5EG	028 700 300 0000	40	026 500 300	G1	2	3	150	60	2.2	0.7	AO8	P
	1D5GT	028 700 300 0000	40	026 500 300	G1	2	3	150	75	2.2	0.6	AO8	P
	1D6	290 193 000 0000	00	280 183 000		25						UX6	R
	1D7	038 748 200 0000	40	036 546 200	G1	2	0	150	75	3	0.42	AO8	P
	1D8	038 748 290 0000	50	037 546 280	G1	1.4	0	90		1.1	0.5	AO8	DTP
	1D8	038 748 290 0000	50	037 546 280	G1	1.4	9	90	90	5	0.9	AO8	DTP
	1DN5	287 904 300 0000	00	265 804 300		1.4		60	60	2.1	0.6	B7G	DP
	1E3	402 203 080 0000	00	402 203 060		1.2	0	150		20	3.5	B9A	T
	1E4	028 040 300 0000	00	026 040 300		1.4	3	90		1.4	0.76	AO8	T
	1E5	038 700 200 0000	40	036 500 200	G1	2	3	150	75	1.7	0.6	AO8	P
	1E7	038 458 270 0000	00	036 447 250		2	4.5	150	150	7.5	1.43	AO8	PP
	1E8	240 238 740 0000	00	240 236 540		1.2	0	60	60	1.8	0.74	B8D	H
	1F2	287 024 300 0000	00	265 024 300		1.4	1.0	90	75	2.9	0.92	B7G	P
	1F3	287 024 300 0000	00	265 024 300		1.4	1.0	90	50	1.9	0.75	B7G	P
	1F4	384 720 000 0000	00	364 520 000		2	3	90	90	4	1.4	UX5	P
	1F5	038 740 200 0000	00	036 540 200		2	3	90	90	4	1.4	AO8	P
	1F6	387 9X2 000 0000	40	365 892 000	G1	2	1.5	150	75	2.2	0.6	UX6	DDP
	1F7	038 9X7 200 0000	40	036 895 200	G1	2	1.5	150	75	2.2	0.6	AO8	DDP
	1F33	287 024 300 0000	00	265 024 300		1.4		90	60	3.5	0.7	B7G	P
	1F34	287 024 300 0000	00	265 024 300		1.2		90	60	3.5	0.7	B7G	P
	1F860	141 230 871 0000	00	141 230 651		20		200	175	10	7.5	B9A	P
	1FD1	209 784 300 0000	00	2*8 564 300		1.4	1.5	60	60	0.17	0.17	B7G	DP
	1FD9	209 784 300 0000	00	208 564 300		1.4	1.0	75	75	1.6	0.63	B7G	DP
	1G3	020 000 300 0000	90	*2* 0*0 3*0	D1	1.2						AO8	D
	1G4	038 040 200 0000	00	036 040 200		1.4	6	90		2.3	0.82	AO8	T
	1G5	038 740 200 0000	00	036 540 200		2	6	90	90	8.5	1.5	AO8	P
	1G6	028 458 300 0000	00	026 447 300		1.4	0	90		1.0	0.67	AO8	TT
	1H1	028 458 300 0000	00	026 447 300		2.1		150		3.2	2.1	AO8	TT
	1H2	230 232 032 0000	90	23* 232 *32	D1	1.4						B9A	D

SPEC.	VALVE TYPE NUMBER	PIN CONNECTIONS				CHARACTERISTICS						BASE	VALVE CLASS
		VCM163 Tester Only		CT160, VT160, VCM Mk 1,2,3,4		Vh	Vg1	Va	Vg2	la	gm mA/V		
		SELECTOR SWITCH	TOP CAP	SELECTOR SWITCH	TOP CAP	V	V	V	V	mA	†Ra MΩ		
	1H3C	028 458 300 0000	00	026 447 300		1.2	5.5	150		2.3	0.8	AO8	TT
	1H4	028 040 300 0000	00	026 040 300		2	9	150		3	0.9	AO8	T
	1H5	238 090 200 0000	40	036 080 200	G1	1.4	0.5	100		0.1	0.2	AO8	DT
	1H6	038 9X4 200 0000	00	036 894 200		2	3	150		0.8	0.57	AO8	DDT
	1H33	287 424 300 0000	00	265 424 300		1.4		90	60	1.6		B7G	H
	1H34	287 424 300 0000	00	265 424 300		1.2		90	60	1.6		B7G	H
	1H35	287 474 300 0000	00	265 454 300		1.4		90	40	0.6		B7G	H
	1J3	020 000 300 0000	90	020 000 300	D1	1.2						AO8	D
	1J5	-	-	036 540 200		2	16.5	150	150	7	0.95	AO8	P
	1J6	028 457 300 0000	00	026 447 300		2	3	150		1.7		AO8	TT
	1J6GX	028 457 300 0000	00	026 447 300		2	0	150		2		AO8	TT
	1K1P	287 024 300 0000	00	265 014 300		1.2	0.5	60	40	1.7	0.65	B7G	P
	1K3	020 000 300 0000	90	020 000 300	D1	1.2						AO8	D
	1K4	387 200 000 0000	40	365 200 000	G1	2		150	75	2.5	1	UX4	P
	1K5	028 700 300 0000	40	026 500 300	G1	2		125	75	2.5	1	AO8	P
	1K5B	028 700 300 0000	40	026 500 300	G1	2		125	75	1	1	AO8	P
	1K6	38X 972 000 0000	40	369 852 000	G1	2	3	150	90	0.9	0.6	UX6	DDP
	1K7	028 9X7 300 0000	40	026 895 300	G1	2	4.4	150	150	1.5	0.7	AO8	DDP
	1L4	287 024 300 0000	00	265 024 300		1.4	0	90	75	2.9	0.92	B7G	P
	1L5	028 740 300 0000	00	026 540 300		2	6	200	200	10	2.4	AO8	P
	1L6	288 471 300 0000	00	266 451 300		1.4	0	90	50	4	0.55	B7G	H
	1L33	284 728 300 0000	00	264 526 300		1.4	7	90	60	7.4	1.4	B7G	P
	1L34	274 728 300 0000	00	254 526 300		1.2	7	90	60	7.4	1.4	B7G	P
	1L60	842 300 000 0000	00	642 300 000		1		150		6.0	1.2	B4	T
	1L84	387 004 020 0000	00	365 004 020		1.4	4.5	90	90	4	0.85	B8B	P
	1L91	872 430 000 0000	00	652 430 000		1.2	4.5	40	40	1.2	0.5	B5A	P
	1L861	041 230 871 0000	00	041 230 651		20		200	200	15	9	B9A	P
	1LA4	387 004 020 0000	00	361 004 020	S	1.4	4.5	90	90	4	0.85	B8B	P
	1LA4E	387 004 020 0000	00	365 004 020		1.4	4.5	90	90	3.5	0.8	B8B	P
	1LA6	388 474 020 0000	00	366 454 020		1.4	0	90	50	1.8	0.55	B8B	H
	1LB4	387 004 020 0000	00	365 004 020		1.4	9	90	90	5	0.9	B8B	P
	1LB6	288 774 430 0000	00	266 554 430		1.4	0	90	75	0.4	0.1	B8B	H
	1LB7	287 104 130 0000	00	265 104 130		1.4	3	40	40	1	0.3	AO8	P
	1LC5	387 124 020 0000	00	365 124 020		1.4	0	90	50	1.15	0.77	B8B	P
	1LC6	288 474 030 0000	00	266 454 030		1.4	0	90	50	3	0.55	B8B	H
	1LD5	387 904 020 0000	00	365 804 020		1.4	0	90	50	0.6	0.57	B8B	DP
	1LE3	370 004 020 0000	00	350 0*4 020		1.4	3	90		1.4	0.76	B8B	T
	1LF3	280 004 030 0000	00	260 004 030		1.4	3	90		1.4	0.76	B8B	T
	1LG5	387 124 020 0000	00	365 124 020		1.4	1.5	90	90	3.7	1.15	B8B	P
	1LH4	280 904 030 0000	00	360 804 020		1.4	0	90		0.15	0.27	B8B	DT
	1LN5	387 124 020 0000	00	365 124 020		1.4	0	90	90	1.6	0.8	B8B	P
	1M1	400 230 080 0000	00	4*0 230 060		1.4	34	250	0	0.99	†2.2	B8B	TI
	1M3	400 230 080 0000	00	4*0 230 060		1.4	23	200	0	0.1	†1.0	B8D	TI
	1M5G	038 700 200 0000	40	036 500 200	G1	2		150	75	2.5	1	AO8	P
	1M90	824 300 000 0000	00	624 300 000		1.4		90		0.25		B4A	T
	1N2	020 000 300 0000	90	*2* *** 3*0	D1	1.2						AO8	D
	1N5	038 700 200 0000	40	036 500 200	G1	1.4		90	90	1.2	0.7	AO8	P
	1N6	038 749 200 0000	00	036 548 200		1.4	4.5	90	90	3.4	0.8	AO8	DP
	1NA31	902 209 300 0000	00	802 208 300		5				15		B7G	R
	1P1	387 024 300 0000	00	365 024 300		1.4	5.2	90	90	5.0	1.4	B7G	P

SPEC.	VALVE TYPE NUMBER	PIN CONNECTIONS				CHARACTERISTICS						BASE	VALVE CLASS
		VCM163 Tester Only		CT160, VT160, VCM Mk 1,2,3,4		Vh	Vg1	Va	Vg2	Ia	gm mA/V		
		SELECTOR SWITCH	TOP CAP	SELECTOR SWITCH	TOP CAP	V	V	V	V	mA	†Ra MΩ		
	1P5	038 700 200 0000	40	036 500 200	G1	1.4		90	90	2.3	0.7	AO8	P
	1P10	284 738 200 0000	00	264 536 200		1.4	7	90	75	7.4	1.57	B7G	P
	1P11	387 024 300 0000	00	365 024 300		1.4	4.5	90	90	9.5	2.15	B7G	P
	1Q5	038 740 200 0000	00	036 540 200		1.4	4.5	90	90	9.5	2.2	AO8	P
	1Q6	040 239 870 0000	00	040 238 650		1.25	0	60	60	1.6	0.6	B8D	DP
	1R	028 710 300 0000	40	026 510 300	G1	1.4		90	90	1.2	0.7	AO8	P
	1R4	200 900 130 0000	00	200 800 130		1.4						B8B	D
	1R5	288 424 300 0000	00	266 424 300		1.4	4	75		5	1.2	B7G	H
	1R5T	281 427 300 0000	00	261 425 300		1.4		90	70	1.15	0.3	B7G	H
	1R6	230 232 032 0000	90	230 232 032	D1	1.2						B9A	D
	1S2A	320 323 023 0000	90	32* 323 *23	D1	1.4						B9A	D
	1S4	284 728 300 0000	00	264 526 300		1.4	7	90	75	7.4	1.57	B7G	P
	1S5	209 784 300 0000	00	208 564 300		1.4	0	75	75	1.6	0.62	B7G	DP
	1S6	804 239 070 0000	00	604 238 050		1.2	0	60	60	1.6	0.6	B8D	DP
	1SA6	021 407 380 0000	00	021 405 360		1.4	0	90	75	2.45	0.97	AO8	P
	1SB6	038 790 240 0000	00	036 580 240		1.4	0	90	75	1.45	0.66	AO8	DP
	1T	038 700 320 0000	40	036 500 320	G1	1.4	4.5	90	90	0.9	2.1	AO8	P
	1T2	123 000 000 0000	90	123 000 000	D1	1.4						B3G	D
	1T4	387 200 000 0000	00	365 200 000		2	0	150	75	2.5	1	UX4	P
	1T4	287 024 300 0000	00	265 024 300		1.4	0	90	75	3.5	0.9	B7G	P
	1T5	038 740 200 0000	00	036 540 200		1.4	6	90	90	6.5	1.15	AO8	P
	1T6	804 239 070 0000	00	604 238 050		1.2	0	60	60	1.6	0.6	B8D	DP
	1U4	287 024 300 0000	00	265 024 300		1.4	0	90	90	0.8	0.68	B7G	P
	1U5	287 904 300 0000	00	265 804 300		1.4	0	75	75	1.6	0.62	B7G	DP
	1U6	288 741 300 0000	00	266 541 300		1.4	0	75	50	1.7	0.3	B7G	H
	1V	291 300 000 0000	00	281 300 000		6.3				60		UX4	R
	1V2	900 230 009 0000	00	8** 230 **8		0.625						B9A	D
	1V4	285 024 300 0000	00	265 *24 300		1.25	0	150	100	1.6		B7G	P
	1V5	040 230 870 0000	00	*4* 23* 650		1.2	4.5	60	60	2	0.75	B7G	P
	1V6	875 248 300 0000	00	654 247 300		1.25	0	45		4.4		B7B	TP
	1V6	875 248 300 0000	00	654 247 300		1.25		45	45	0.4	0.2	B7B	TP
	1W4	9X2 300 000 0000	00	892 300 000		4				30		B4	RR
	1W4	287 004 300 0000	00	265 004 300		1.4	9	90	90	5	0.92	B7G	P
	1W5	040 230 870 0000	00	040 230 650		1.25	0	60	60	1.8	0.73	B84	P
	1W50	942 310 000 0000	00	842 010 000		1.0	0.5	100		0.2	0.2	B5	T
	1X2	230 232 032 0000	90	230 232 032	D1	1.2						B9A	D
	1X2B	020 000 003 0000	90	020 000 003	D1	1.2						B9A	D
	1Y2	200 300 000 0000	90	200 300 000	D1	1.4						UX4	R
	1Y32	232 232 300 0000	90	232 232 300	D1	1.4						B7G	D
	1Z1	020 000 300 0000	90	020 000 300	D1	0.7						AO8	D
	1Z2	232 232 300 0000	90	232 232 300	D1	1.2						B7G	D
	2	842 300 000 0000	00	642 300 000		2	4	150		1.5		B4	T
	2/25A	200 300 000 0000	90	200 300 000	D1	6.3				30		UX4	R
	2/50A	200 300 000 0000	90	200 300 000	D1	5				60		UX4	R
	2A1M	028 748 300 0000	40	026 546 300	G1	2		150	75	2.2		AO8	H
	2A3	284 300 000 0000	00	264 300 000		2.5	45	250		60	5.2	UX4	T
	2A3H	384 200 000 0000	00	364 200 000		2.5	62	300		40	5.25	UX4	T
	2A3W	284 300 000 0000	00	264 300 000		2.5	45	250		60	5.2	UX4	T

SPEC.	VALVE TYPE NUMBER	PIN CONNECTIONS				CHARACTERISTICS						BASE	VALVE CLASS
		VCM163 Tester Only		CT160, VT160, VCM Mk 1,2,3,4		Vh	Vg1	Va	Vg2	la	gm mA/V		
		SELECTOR SWITCH	TOP CAP	SELECTOR SWITCH	TOP CAP	V	V	V	V	mA	†Ra MΩ		
	2A5	287 413 000 0000	00	265 413 000		2.3(3)	16.5	250	250	34	2.5	UX6	P
	2A6	28X 913 000 0000	40	269 813 000	G1	2.5	2	250		0.9	1.1	UX6	DDT
	2A7	287 741 300 0000	40	265 541 300	G1	2.5	8	250	100	3.5	1.1	Sm7	H
	2AF4	842 314 800 0000	00	642 314 600		2.5	4.0	100		15	6.6	B7G	T
	2AH2	200 000 000 0030	90	-		2.5						A12	D
	2AS2	220 002 002 0030	90	-		2.5				5		A12	D
	2AV2	900 230 009 0000	00	800 230 008		1.8						B9A	D
	2AZ2	230 232 032 0000	90	230 232 032		2.1						B9A	D
	2B3	020 000 300 0000	90	*20 000 3*0	D1	1.7						AO8	D
	2B5	280 413 000 0000	00	267 413 000		2.5		300		9		UX6	TT
	2B5	208 413 000 0000	00	267 413 000		2.5		300		9		UX6	TT
	2B5	834 225 380 0000	00	634 224 370		1.2	1	90		2.6	1.1	B8A	TT
	2B7	287 9X1 300 0000	40	265 891 300	G1	2.5	3	250	125	9	1.1	UX7	DDP
	2B21	300 200 000 0000	90	300 200 000	D1	2.5				5		UX4	R
	2B22	021 010 310 0000	90	021 010 310	D1	6.3						AO8	D
	2B25	200 900 300 0000	00	200 800 300		1.4						B7G	D
	2B26	290 300 000 0000	00	280 300 000		2.5				120		UX4	R
	2BN4	142 381 400 0000	00	142 381 400		2	1.5	150		9	6.8	B7G	T
	2BU2	220 000 030 0030	80	-	A	2.5		60		7.0		A12	R
	2C21	218 481 300 0000	50	217 461 300	G1	6.3	16.5	250		8.3	1.3	UX7	TT
	2C22	020 000 310 0000	84	020 000 310	A1G1	6.3	10.5	300		11	3	AO8	T
	2C23	284 300 000 0000	00	264 300 000		7.5	32	350		16	1.55	UX4	T
	2C25	284 300 000 0000	00	264 300 000		7	100	350		50		UX4	T
	2C26	020 000 310 0000	84	020 000 310	A1G1	6.3	15	350		16		AO8	T
	2C34	204 150 300 0000	88	204 140 300	A1A2	6.3	36	300		80		Sm7	TT
	2C40	021 010 310 0000	84	*21 010 310	A1G1	6.3	5	250		20		AO8	T
	2C43	021 010 310 0000	84	*21 010 310	A1G1	6.3		400		38		AO8	T
	2C45	384 200 000 0000	00	364 200 000		7	40	250		29		UX4	T
	2C48	287 004 130 0000	00	265 004 130		6.3	15	250	250	70		B8B	P
	2C50	481 581 230 0000	00	461 471 230		12.6		200		18	2.9	AO8	TT
	2C50	287 004 130 0000	00	265 004 130		12	15	250	250	70		B8B	P
	2C51	214 808 513 0000	00	214 607 413		6.3	2	150		8.2	5.5	B9A	TT
	2C52	481 581 230 0000	00	461 471 230		12.5	2	250		1.3	1.9	AO8	TT
	2CN3A	-	-	-		1.8	.6	150		9.0	7.7	B7G	T
	2CW4	080 400 010 2030	00	-		2.1	1	100		7.6	9.8	NV5	T
	2CY5	412 387 100 0000	00	412 365 100		2.5	1	150	80	10	8	B7G	P
	2D1	29X 130 000 0000	00	289 130 000		2.5						UX5	DD
	2D2	9X2 310 000 0000	00	892 310 999		2						B5	DD
	2D4	9X2 310 000 0000	00	892 310 000		4						B5	DD
	2D4B	0X1 231 900 0000	00	091 231 800		4						B7	DD
	2D13	023 190 000 0000	XO	023 180 000	D2	13						B5	DD
	2D13A	923 1X0 000 0000	00	823 190 000		13						B5	DD
	2D13C	9X2 310 000 0000	00	892 310 000		13						B5	DD
	2D21	412 318 100 0000	00	412 316 100		6.3	5	200		26	†6k+M5	B7G	THY
	2D21	412 318 100 0000	00	412 316 100		6.3	9	400		55	†6kΩ	B7G	THY
	2DL4	414 234 484 0000	00	414 234 464		2		150		12.5	14	B9A	T
	2DS4	080 400 010 2030	00	-		2.1	0.8	100		6.5	9	NV5	T
	2DV4	880 404 100 2030	00	-		2.1	1	75		10.5	11.5	NV7	T
	2DZ4	842 314 800 0000	00	642 314 600		2.35		75		15	6.7	B7G	T
	2E5	284 713 000 0000	00	264 513 000		2.5	8	250		0.2	†1.0	AO8	TI

SPEC.	VALVE TYPE NUMBER	PIN CONNECTIONS				CHARACTERISTICS						BASE	VALVE CLASS
		VCM163 Tester Only		CT160, VT160, VCM Mk 1,2,3,4		Vh	Vg1	Va	Vg2	la	gm mA/V		
		SELECTOR SWITCH	TOP CAP	SELECTOR SWITCH	TOP CAP	V	V	V	V	mA	†Ra MΩ		
	2E22	274 130 000 0000	80	254 130 000	A1	6.3	15	400	250	60	5.5	UX5	P
	2E24	237 242 300 0000	80	235 242 300	A1	3	18.5	400	200	16	3.2	AO8	P
	2E25	020 740 320 0000	00	020 540 320		6.3	22.5	400	250	40		AO8	P
	2E26	127 141 300 0000	80	125 141 300	A1	6.3	20	200	200	20	3.5	AO8	P
	2E30	413 387 200 0000	00	413 365 200		3	20	250	250	40	3.7	B7G	P
	2E31	872 430 000 0000	00	652 430 000		1.25	0	20	20	0.4	0.5	B5A	P
	2E35	872 430 000 0000	00	652 430 000		1.25	0	20	20	0.27	0.38	B5A	P
	2E41	879 243 000 0000	00	658 243 000		1.25	0	20	20	0.36	0.37	B5A	P
	2E50	412 287 300 0000	00	412 265 300		6.3	20	250	250	10	3.4	B7G	P
	2EA5	412 387 100 0000	00	412 365 100		2.3	1	250	150	10	8	B7G	P
	2EN5	0X2 310 900 0000	00	092 310 800		2.1						B7G	DD
	2ER5	142 380 100 0000	00	142 360 100		2.3	1.2	200		10		B7G	T
	2ES5	142 380 100 0000	00	142 360 100		2.3	1	200		15	9.5	B7G	T
	2EV5	412 387 100 0000	00	412 365 100		2.4		250	75	11.5	8.8	B7G	P
	2F7	287 841 300 0000	50	275 641 300	G1	2.5	3	100		4		UX7	TP
	2F7	287 841 300 0000	50	275 641 300	G1	2.5	3	250	100	2.8		UX7	TP
	2FH5	142 380 100 0000	00	142 360 100		2.3	1	150		11	9	B7G	T
	2FQ5	142 380 100 0000	00	142 360 100		2.3	1.2	150		11.5	11	B7G	T
	2FS5	412 387 100 0000	00	412 365 100		2.4	0.2	275	150	10	10	B7G	P
	2FV6	287 424 300 0000	00	265 424 300		2.4	1	150	75	10	8	B7G	P
	2FY5	142 380 100 0000	00	142 360 100		2.4	1.2	150		11	12	B7G	T
	2G5	284 713 000 0000	00	264 513 000		2.5	22	250	250	0.2		UX6	TI
	2GK5	142 380 100 0000	00	142 360 100		2.3	1.2	150		11	15	B7G	T
	2GU5	412 381 100 0000	00	412 361 100		2.4	0.4	135	135	10	15.5	B7G	H
	2GW5	842 314 100 0000	00	642 314 000		2.4	1	150		13	15	B7G	T
	2H1	-	00	026 447 300		2.1		150		3.2	2.1	AO8	TT
	2HA5	412 380 100 0000	00	412 360 100		2.2		200		19	20	B7G	T
	2HK5	412 380 100 0000	00	412 360 100		2.3		150		12.5	15	B7G	T
	2HM5	412 387 100 0000	08	412 365 100		2.4	1.2	150		12.5	14.5	B7G	T
	2HMD	472 310 000 0000	80	452 310 000	A1A2	4		200	100	3.8	1.1	B5	PP
	2HMD	572 310 000 0000	80	452 310 000	A1A2	4		200	100	3.8	1.1	B5	PP
	2HQ5	412 381 100 0000	00	412 361 100		2.4	1	150		11.5	15	B7G	T
	2HR8	701 238 014 0000	00	501 236 014		2.1		250	150	3	1.8	B9A	P
	2J2	230 232 032 0000	90	230 232 032	D1	2						B9A	D
	2K2	028 700 300 0000	40	026 500 300	G1	2	2	100	100	2.5	0.9	AO8	P
	2L32	284 738 200 0000	00	264 536 200		1.4	7	60	60	7	1.5	B7G	P
	2L33	287 438 200 0000	00	265 436 200		1.4	8.4	150	90	14.1	1.9	B7G	P
	2L35	287 143 200 0000	00	265 143 200		1.2	8.8	150	90	14.2	2.1	B7G	P
	2M2M	284 738 200 0000	00	264 536 200		1.2	3.5	60	60	3.7	1.1	B7G	P
	2-01C	200 000 300 0000	90	2** *** 300	D1	5						B7G	D
	2P	842 300 000 0000	00	642 300 000		2	22	250		40	7	B4	T
	2P1P	284 738 200 0000	00	204 510 300		1.2	3.5	60	60	2.8	0.9	B7G	P
	2S	29X 130 000 0000	00	289 130 000		2.5				15		UX5	RR
	2S/140G	209 130 900 0000	00	208 130 800		6.3				5		B7G	R
	2S/280F	-	-	*12 3** *00	D1	4				30		B7G	R
	2SC10	842 300 000 0000	00	642 300 000		2.5	1	250		15	2.4	B4	T
	2T4	842 310 800 0000	00	642 310 600		2.3	2.7	75		18	7	B7G	T
	2T/270K	112 311 100 0000	90	112 311 100	D1	4						B7G	R
	2U14	842 300 000 0000	00	642 300 000		2		150		2	0.6	B4	T
	2U15	842 300 000 0000	00	642 300 000		2		150		4	0.8	B4	T
	2V2	020 000 030 0000	90	020 000 030	D1	2.5						AO8	D

SPEC.	VALVE TYPE NUMBER	PIN CONNECTIONS				CHARACTERISTICS						BASE	VALVE CLASS	
		VCM163 Tester Only		CT160, VT160, VCM Mk 1,2,3,4		Vh	Vg1	Va	Vg2	la	gm mA/V			
		SELECTOR SWITCH	TOP CAP	SELECTOR SWITCH	TOP CAP	V	V	V	V	mA	†Ra MΩ			
	2V3	020 000 300 0000	90	020 000 300	D1	2.5(3)							AO8	R
	2W3	020 900 030 0000	00	020 800 030		2.5				60			AO8	R
	2X2	300 200 000 0000	90	300 200 000	D1	2.5(3)							UX4	R
	2X3	020 900 030 0000	00	020 800 030		2.5				120			AO8	R
	2XP	842 300 000 0000	00	642 300 000		2	36	300		50	7		B4	T
	2Y2	200 300 000 0000	90	200 300 000	D1	2.5				5			UX4	R
	2Z2	290 300 000 0000	00	280 300 000		2.5				60			UX4	R
	2.5C9	842 300 000 0000	00	642 300 000		2.5	4	250		8	2.2		B4	T
	3	842 300 000 0000	00	642 300 000		2	7.5	150		3.4	0.9		B4	T
	3A2	230 232 032 0000	90	230 232 032	D1	3							B9A	D
	3A3	020 000 300 0000	90	*2* 0*0 3*0	D1	3							AO8	D
	3A3A	020 000 300 0000	80	020 000 300	A	3.15		100		7.0				R
	3A3B	020 000 300 0000	80	020 000 300	A	3.15		100		7.0				R
	3A8	238 748 390 0000	50	237 546 380	G1	1.4	0	90		0.2	0.3		AO8	DTP
	3A8	238 748 390 0000	50	237 546 380	G1	1.4	0	90	90	12	0.7		AO8	DTP
	3A/107A	284 300 000 0000	00	264 300 000		4	8	150		6.5	1.6		UX4	T
	3A/107B	842 300 000 0000	00	642 300 000		4	8	150		6.5	1.6		B4	T
	3A/108A	284 300 000 0000	00	264 300 000		2	1.5	150		0.9	0.5		UX4	T
	3A/108B	842 300 000 0000	00	642 300 000		2	1.5	150		0.9	0.5		B4	T
	3A/109A	284 300 000 0000	00	264 300 000		4	8	150		19	1.2		UX4	T
	3A/109B	842 300 000 0000	00	642 300 000		4	8	150		19	1.2		B4	T
	3A/154M	280 004 130 0000	00	260 0*4 130		6.3	2	250		12	3		B8B	T
	3A/167M	200 810 430 0000	00	2*0 61* 430		6.3	3.5	200		10	30		B8G	T
	3AE4	387 004 230 0000	00	365 004 230		1.4	9	90	90	1.8	1.6		AO8	P
	3AF4	842 314 800 0000	00	642 314 600		3	4	100		15	6.6		B7G	T
	3AJ8	751 238 584 0000	00	541 237 464		3.1	3	100		5	2.3		B9A	TH
	3AJ8	751 238 584 0000	00	541 237 464		3.1	2	250	100	6.5	2.4		B9A	TH
	3AL5	1X2 310 900 0000	00	192 310 800		3				5			B7G	DD
	3AT2A	220 000 030 0030	80	020 000 300	A	3.15		140		20.0			A12	R
	3AT2	200 000 000 0030	90	-		3.15							A12	D
	3AT4	802 304 100 0000	00	602 304 100		3.1	1	200		11.5	6.7		B7G	T
	3AU6	412 387 100 0000	00	412 365 100		3	1.0	250	150	10	5.2		B7G	P
	3AV6	412 3X9 800 0000	00	412 398 600		3	2	250		1.2	1.6		B7G	DDT
	3AW2A	220 000 030 0030	80	020 000 300	A	3.15		60		7.0			A12	R
	3AW3	020 000 300 0000	90	*2* 0*0 3*0	D1	3.1							AO8	D
	3AY6	412 39X 800 0000	00	412 389 600		3	2	250		1.2	1.6		B7G	DDT
	3AZ4	020 90X 030 0000	00	020 809 030		5				60			AO8	RR
	3B2	020 000 300 0000	90	*2* 0** 3*0	D1	3							B8A	D
	3B4	724 332 800 0000	00	524 332 600		1.25	10	150	125	30	2.2		B7G	P
	3B5	038 740 320 0000	00	036 540 320		1.4	7	75	75	6.7	1.5		AO8	P
	3B7	384 205 830 0000	00	364 204 730		1.4	0	90		5.2	1.85		B8B	TT
	3B24	320 200 000 0000	90	320 200 000	D1	2.5				30			UX4	R
	3B29	300 200 000 0000	90	300 200 000	D1	2.5							UX4	R
	3B/102B	843 210 000 0000	00	643 210 000		6.3		400		100	6		B5	T
	3B/240M	214 444 130 0000	80	214 444 130	A1	6.3	1	300		50	27		B8B	T
	3B/241M	214 444 130 0000	80	214 444 130	A1	19	1	300		50	27		B8B	T
	3B/252B	842 310 000 0000	00	642 310 000		6.3	20	400		60	10		B5	T
	3BA6	412 387 100 0000	00	412 365 100		3	1	250	100	11	4.4		B7G	P
	3BC5	412 387 100 0000	00	412 365 100		3	1.3	250	150	7.5	5.7		B7G	P
	3BE6	412 388 100 0000	00	412 365 100		3.1	6	150	100	7.5	3.5		B7G	H
	3BF2	200 200 200 3030	90	-		3.6							A12	D
	3BF6	142 380 100 0000	00	142 360 100		3.1	9	250		9.5	1.9		B7G	T

SPEC.	VALVE TYPE NUMBER	PIN CONNECTIONS				CHARACTERISTICS						BASE	VALVE CLASS
		VCM163 Tester Only		CT160, VT160, VCM Mk 1,2,3,4		Vh	Vg1	Va	Vg2	la	gm mA/V		
		SELECTOR SWITCH	TOP CAP	SELECTOR SWITCH	TOP CAP	V	V	V	V	mA	†Ra MΩ		
	3BL2A	110 011 011 0010	00	-	A	3.3		50		7.0		A12	R
	3BM2A	-	-	-	A	3.0		50		7.0		A12	R
	3BN2A	230 000 000 0000	00	230 000 000	A	3.15		150		7.0		A12	R
	3BN4	142 381 400 0000	00	142 361 400		2.8	2	150		9	6.8	B7G	T
	3BN4A	142 381 400 0000	00	142 361 400		3.0	-6	150		9	7.7	B7G	T
	3BN6	412 374 800 0000	00	412 354 600		3	1	60	60	0.5	1	B7G	P
	3BU8	178 231 401 0000	00	157 231 461		3	1	100	60	1	1.5	B9A	PP
	3BU8	170 231 481 0000	00	157 231 461		3	1	100	60	1	1.5	B9A	PP
	3BX6	141 230 871 0000	00	141 230 651		3.4	2	200	175	10	7.2	B9A	P
	3BY6	412 387 400 0000	00	412 365 400		3	2.5	250	100	6.5	2.4	B7G	H
	3BY7	141 230 871 0000	00	141 230 651		3.2	1.8	250	75	8	5.7	B9A	P
	3BZ6	412 387 100 0000	00	412 365 100		3	1.0	150	125	14	8	B7G	P
	3C2	020 030 200 0000	00	020 *3* 2*0		1.5						AO8	D
	3C5	038 740 320 0000	00	036 540 320		1.4	9	90	90	6	1.4	AO8	P
	3C6	208 458 320 0000	00	206 447 320		1.4	0	90		4.5	1.3	B8D	TT
	3C24	200 300 000 0000	84	200 300 000	A1G1	6.3	3	400		4.5	1.2	UX4	T
	3036	412 387 100 0000	00	412 365 100		3	2.2	200	150	9.5	6.2	B7G	P
	3CA3	030 000 200 0000	90	030 000 200	D1	3.6						AO8	D
	3CB6	412 387 100 0000	00	412 365 100		3	1.0	150	125	13	8.0	B7G	P
	3CE5	412 387 100 0000	00	412 365 100		3.1	2.1	200	150	9.5	6.2	B7G	P
	3CF5	402 387 100 0000	00	402 365 100		3.1		150	125	11	7.6	B7G	P
	3CF6	412 387 100 0000	00	412 365 100		3	1.0	150	125	12	7.8	B7G	P
	3CN3A	020 000 300 0000	80	020 000 300	A	3.15		60		7.0			R
	3CS6	412 387 100 0000	00	412 365 100		3	1.0	100	30	1.0	1.1	B7G	H
	3CU3	020 000 300 0000	80	020 000 300	A	3.15		50		7.0			R
	3CY5	412 387 100 0000	00	412 365 100		2.9	1	150	75	10	9	B7G	P
	3CZ3	020 000 300 0000	80	020 000 300	A	3.15		60		7.0		B8B	R
	3D21A	320 704 210 0000	80	320 504 210	A1	6.3	30	400	300		5.5	AO8	P
	3DB3	230 000 000 0000	80	230 000 000	A	3.15		100		7.0		AO8	R
	3DC3	230 000 000 0000	80	230 000 000	A	3.15		50		7.0		AO8	R
	3DG4	101 090 X00 0000	00	1*1 080 900		3.3				120		AO8	RR
	3DJ3	230 000 000 0000	80	230 000 000	A	3.15		70		7.0		B8-25	R
	3DK6	412 387 100 0000	00	412 365 100		3.1	0.9	150	125	12	9.8	B7G	P
	3DL4	414 234 484 0000	00	414 234 464		2.6	1.2	150		12	14	B9A	T
	3DT6	412 387 100 0000	00	412 365 100		3.15	2.2	150	100	1.1	0.8	B7G	P
	3DT6A	412 387 400 0000	00	412 365 100		3.15	5.2	150	100.0	1.55	1.35	B7G	P
	3DZ4	842 314 800 0000	00	642 314 600		3.2		75		15	6.7	B7G	T
	3E5	387 024 300 0000	00	365 024 300		1.4	8	90	90	6	1.2	B7G	P
	3E6	287 134 020 0000	00	265 134 020		1.4	0	90	90	2.5	1.8	AO8	P
	3EA5	402 387 100 0000	00	402 365 100		3	1	250	100	10	8	B7G	P
	3EH7	141 230 871 0000	00	141 230 651		3.4	2	200	90	12	12.5	B9A	P
	3EJ7	141 230 710 0000	00	141 230 510		3.4	2.5	200	200	10	15	B9A	P
	3ER5	142 380 100 1000	00	142 360 100		3.6	1.2	250		10	10.5	B7G	T
	3ES5	142 380 100 0000	00	142 360 100		3	1	200		15	9.5	B7G	T
	3EV5	412 387 100 0000	00	412 365 100		2.9		250	75	11.5	8.5	B7G	P
	3FH5	142 380 100 0000	00	142 360 100		3	1	250		11	9	B7G	T
	3FQ5	142 380 100 0000	00	142 360 100		2.8	1.2	150		11.5	11	B7G	T
	3FS5	412 387 100 0000	00	412 365 100		2.9	0.2	300	150	9	10	B7G	P
	3FY5	142 380 100 0000	00	142 360 100		3.1	1	150		11	13	B7G	T



SPEC.	VALVE TYPE NUMBER	PIN CONNECTIONS				CHARACTERISTICS						BASE	VALVE CLASS
		VCM163 Tester Only		CT160, VT160, VCM Mk 1,2,3,4		Vh	Vg1	Va	Vg2	la	gm mA/V		
		SELECTOR SWITCH	TOP CAP	SELECTOR SWITCH	TOP CAP	V	V	V	V	mA	†Ra MΩ		
	3G10	9X2 300 000 0000	00	892 300 000		2.5				30		B4	RR
	3GK5	142 380 100 0000	00	142 360 100		2.8	1	150		11.5	15	B7G	T
	3GS8	178 231 401 0000	00	156 231 471		3.1		100	75	2	1.2	B9A	PP
	3GS8	170 231 481 0000	00	156 231 471		3.1		100	75	2	1.2	B9A	PP
	3GW5	842 314 100 0000	00	642 314 100		3	1	150		13	15	B7G	T
	3HA5	412 380 100 0000	00	412 360 100		2.7		200		19	20	B7G	T
	3HK5	412 380 100 0000	00	412 360 100		2.9	1	150		12.5	15	B7G	T
	3HM5	412 380 100 0000	00	412 360 100		2.9	1.2	150		12.5	14.5	B7G	T
	3HM6	141 230 871 0000	00	141 230 621		3.15	3.9	125	125	13	15	B9A	P
	3HQ5	412 381 100 0000	00	412 361 100		3	1	150		11.5	15	B7G	T
	3HS8	178 231 401 0000	00	157 231 461		3.1		100	75	2	0.4	B9A	PP
	3HS8	170 231 481 0000	00	157 231 461		3.1		100	75	2	0.4	B9A	PP
	3JC6	141 230 871 0000	00	141 230 651		3.5	3	125	125.0	14.0	16	B9A	P
	3JC6A	141 230 871 0000	00	141 230 651		3.5	3	125	125.0	14.0	16	B9A	P
	3JD6	141 230 871 0000	00	141 230 651		3.5	0	125	125.0	15.0	1.4	B9A	P
	3JD6A	141 230 871 0000	00	141 230 651		3.5	0	125	125.0	15.0	1.4	B9A	P
	3KF8	170 231 481 0000	00	156 231 471		3.1	1	150	150	4	1	B9A	PP
	3KF8	178 231 501 0000	00	156 231 471		3.1	1	150	150	4	1	B9A	PP
	3KT6	141 230 871 0000	00	140 230 651		3.5	0	330	330.0	17.0	18.0	B9A	P
	3L31	287 438 200 0000	00	265 436 200		1.4	8.7	150	90	14.2	2.1	B7G	P
	3L35	287 243 200 0000	00	265 243 200		1.4		150	125	18.5		B7G	P
	3LE4	387 004 230 0000	00	365 004 230		1.4	9	90	90	1.8	1.6	AO8	P
	3LF4	387 004 230 0000	00	365 004 230		1.4	4.5	90	90	8	2	B8B	P
	3Q4	384 728 300 0000	00	364 526 300		1.4	5	90	90	6.9	1.97	B7G	P
	3Q5	038 740 320 0000	00	036 540 320		1.4	4.6	90	90	9	2	AO8	P
	3S4	384 728 300 0000	00	364 526 300		1.4	7	90	75	7.4	1.57	B7G	P
	3SB6	038 740 200 0000	00	036 540 200		1.4		90	60	1.4	0.6	AO8	P
	3V4	387 024 300 0000	00	365 024 300		1.4	4.5	90	90	7.7	2	B7G	P
	3W4	284 738 200 0000	00	264 536 200		1.4	5.2	90	90	6.8	1.7	B7G	P
	3Y4	284 738 200 0000	00	264 536 200		1.4	5.4	60	60	5	1.2	B7G	P
	3Y6A1	023 104 780 0000	00	023 104 560		6.3		400	300		2	F8	P
	3Z4	284 738 200 0000	00	264 536 200		1.4	7	60	60	6.5	1.4	B7G	P
	4	842 300 000 0000	00	642 300 000		2	1	150		1	0.9	B4	T
	4A6G	028 458 230 0000	00	026 447 230		2	1.5	90		1.2	0.9	AO8	TT
	4A07	842 300 000 0000	00	642 300 000		4	2	100		1.4	1.2	B4	T
	4A08N	842 300 000 0000	00	642 300 000		4		200		6	2.4	B4	T
	4A10	842 300 000 0000	00	642 300 000		4	2.5	150		6	1.8	B4	T
	4A15	842 300 000 0000	00	642 300 000		4		100		7	2.2	B4	T
	4A80	842 310 000 0000	00	642 310 000		4		150		6	2	B5	T
	4A80N	842 310 000 0000	00	642 310 000		4		200		6	2.4	B5	T
	4A90	842 310 000 0000	00	642 310 000		4		200		8	3.5	B5	T
	4A120	842 310 000 0000	00	642 310 000		4		150			1.4	B5	T
	4AU6	412 387 100 0000	00	412 365 100		4	1	250	150	10	5.2	B7G	P
	4AV6	412 39X 800 0000	00	412 389 600		4.2	2	250		1.2	1.6	B7G	DDT
	6BA6	412 387 100 0000	00	412 365 100		4.2	1	250	100	11	4.4	B7G	P
	4BC5	412 387 100 0000	00	412 365 100		4.2	1.3	250	150	7.5	5.7	B7G	P
	4BC8	841 238 510 0000	00	741 236 410		4.2	2.2	150		10	6.2	B9A	TT
	4BE6	412 388 100 0000	00	412 365 100		4.2	6	150		7.5	3.5	B7G	H
	4BL8	857 238 114 0000	00	645 237 114		4.5	2	100		14	5	B9A	TP
	4BL8	857 238 114 0000	00	645 237 114		4.5	2	200	175	10	6.2	B9A	TP
	4BN4	142 381 400 0000	00	142 361 400		4	2.2	150		9	7	B7G	T

SPEC.	VALVE TYPE NUMBER	PIN CONNECTIONS				CHARACTERISTICS						BASE	VALVE CLASS
		VCM163 Tester Only		CT160, VT160, VCM Mk 1,2,3,4		Vh	Vg1	Va	Vg2	la	gm mA/V		
		SELECTOR SWITCH	TOP CAP	SELECTOR SWITCH	TOP CAP	V	V	V	V	mA	†Ra MΩ		
	4BN6	142 374 800 0000	00	142 354 600		4.2	1	60	60	0.5	1.0	B7G	P
	4BQ7	851 238 410 0000	00	741 236 410		4	2	150		9	6.4	B9A	TT
	4BS8	841 238 510 0000	00	641 237 410		4.2	4.4	150		10	7.2	B9A	TT
	4BU8	170 231 481 0000	00	157 231 461		4.2	1	150	100	4	3.5	B9A	PP
	4BU8	178 231 581 0000	00	157 231 461		4.2	1	150	100	4	3.5	B9A	PP
	4BX8	841 238 510 0000	00	641 237 410		4.2	1	65		9	6.7	B9A	TT
	4BZ6	412 387 100 0000	00	412 365 100		4.2	1	100	100	12	8	B7G	P
	4BZ7	851 238 410 0000	00	741 236 410		4.2	2.2	150		10	6.8	B9G	TT
	4BZ8	841 238 510 0000	00	641 237 410		4.2	2	150		10	8	B9A	TT
	4BZ11	841 238 510 0000	00	741 236 410		4	2.2	150		10	6.8	B9A	TT
	4C1	284 300 000 0000	00	264 300 000		3	3	90		5	1	UX4	T
	4C2	842 310 000 0000	00	642 310 000		4	5	150		11	2.5	B5	T
	4C3	842 310 000 0000	00	642 310 000		4	3.5	200		6	2.4	B5	T
	4C5	842 300 000 0000	00	642 300 000		4	10	400		30	4	B4	T
	4C101	023 004 080 0000	00	023 004 060		4	45	250		60	6	F8	T
	4C102	842 300 000 0000	00	642 300 000		4	45	250		40	2	B4	T
	4C103	842 300 000 0000	00	642 300 000		4	35	250		45	3.5	B4	T
	4CB6	412 387 100 0000	00	412 365 100		4.2	1	150	125	13	8	B7G	P
	4CC1	842 301 850 0000	00	642 301 140		4	3.5	200		6	3.2	F8	TT
	4CE5	412 387 100 0000	00	412 365 100		4.2	1	150	125	11	7.6	B7G	P
	4CF6	412 387 100 0000	00	412 365 100		4.2	2	200	150	9.5	6.2	B7G	P
	4CF8	701 238 014 0000	00	501 236 014		4.5	2	250	150	3	2	B9A	P
	4CM4	841 234 148 0000	00	641 234 146		3.6	1.5	200		12	14	B9A	T
	4CS6	412 387 100 0000	00	412 365 100		4	1	100	30	1	11	B7G	P
	4CX7	841 238 510 0000	00	641 237 410		4.2	10	150		9	6.4	B9A	TT
	4CY5	412 387 100 0000	00	412 365 100		4.2	1	150	80	10	8	B7G	P
	4D1	000 231 800 0000	40	000 231 600	G1	13	3	250		10	5	B7	T
	4D80	842 310 000 0000	00	642 310 000		4		100		2	1	B5	T
	4DE6	412 387 100 0000	00	412 365 100		4.2	1.1	150	125	15.5	8	B7G	P
	4DK6	412 387 100 0000	00	412 365 100		4.2	0.9	150	125	12	9.7	B7G	P
	4DL4	414 234 484 0000	00	414 234 464		4	1.2	150		12	14	B9A	T
	4DT6	412 387 100 0000	00	412 365 100		4.2		150	150	12	9	B7G	P
	4E2	023 19X 780 0000	40	923 189 560	G1	4	14	250	275	72		8SC	DDP
	4E4	023 110 780 0000	40	023 110 560	G1	4	2	250	100	3	2.1	8SC	P
	4E104	287 004 130 0000	00	265 004 130		4	6	250	250	36	9	B8G	P
	4E204	023 110 780 0000	00	023 110 560		4	3	250	100	8	1.8	F8	P
	4EH7	141 230 871 0000	00	141 230 651		4.4	2	200	100	12	12.5	B9A	P
	4EJ7	141 230 871 0000	00	141 230 651		4.4	2.5	200	200	10	15	B9A	P
	4ER5	142 380 100 0000	00	142 360 100		4.2	1.2	200		10	10.5	B9A	T
	4ES8	851 238 410 0000	00	741 236 410		4	1.2	90		15	12.5	B9A	TT
	4EW6	412 387 100 0000	00	412 365 100		4.2	0.8	150	125	11	14	B7G	P
	4FC7	148 234 118 0000	00	146 234 117		3.8	1.2	90		15	12.3	B9A	T
	4FS7	151 234 887 0000	00	141 234 675		4.6	3	100		14	5.5	B9A	TP
	4FS7	151 234 887 0000	00	141 234 675		4.6	1.2	200	150	10	1.2	B9A	TP
	4G30	9X2 300 000 0000	00	892 300 000		4				15		B4	RR
	4G105	9X2 300 000 0000	00	892 300 000		4				30		B4	RR
	4G200	9X2 300 000 0000	00	892 300 000		4				60		B4	RR
	4G5000	023 000 000 0000	90	023 000 000	D1	4						F8	R
	4GG1	9X2 300 000 0000	00	892 300 000		4				30		B4	RR
	4GG2	9X2 300 000 0000	00	892 300 000		4				60		B4	RR

SPEC.	VALVE TYPE NUMBER	PIN CONNECTIONS				CHARACTERISTICS						BASE	VALVE CLASS
		VCM163 Tester Only		CT160, VT160, VCM Mk 1,2,3,4		Vh	Vg1	Va	Vg2	la	gm mA/V		
		SELECTOR SWITCH	TOP CAP	SELECTOR SWITCH	TOP CAP	V	V	V	V	mA	†Ra MΩ		
4GG3	9X2 300 000 0000	00	892 300 000			4				120		B4	RR
4GG4	023 090 0X0 0000	00	023 080 090			4				30		F8	RR
4GK5	142 380 100 0000	00	142 360 100			4	1	150		11.5	15	B7G	T
4GM6	412 387 100 0000	00	412 365 100			4.2		150	125	14	13	B7G	P
4GS8	178 231 401 0000	00	156 231 401			4.2		100	75	2	1.2	B9A	PP
4GS8	170 231 481 0000	00	156 231 471			4.2		100	75	2	1.2	B9A	PP
4GW5	842 314 100 0000	00	642 314 000			4.2	1	150		13	15	B7G	T
4GX7	151 238 784 0000	00	141 236 574			4.2	1	125		13	8.5	B9A	TP
4GX7	151 238 784 0000	00	141 236 574			4.2	1	125	125	8	11	B9A	TP
4GZ5	142 347 800 0000	00	142 345 600			4		250	250	16	8.5	B7G	P
4H07	842 300 000 0000	00	642 300 000			4		150		3	1.1	B4	T
4H08	842 300 000 0000	00	642 300 000			4		150		5	1.2	B4	T
4H80	842 300 000 0000	00	642 300 000			4		150		3	1.1	B4	T
4HA5	412 380 100 0000	00	412 360 100			3.9		200		19	20	B7G	T
4HA7	281 100 005 8430	00	261 100 004			4.2	8.5	250		10.5	2.2	A12	TT
4HA7	281 100 005 8430	00	261 100 004			4.2	2	250		1.2	1.6	A12	TT
4HK5	412 380 100 0000	00	412 360 100			4.0		150		12.5	15	B7G	T
4HM5	412 387 100 0000	00	412 365 100			4	1.2	150		12.5	14.5	B7G	T
4HM6	141 230 871 0000	00	141 230 651			4.2	3.9	125	125	13	15	B9A	P
4HQ5	412 380 100 0000	00	412 361 100			4.2	1.0	150		11.5	15	B7G	T
4HS8	178 231 481 0000	00	157 231 461			4.2		100	75	2	0.4	B9A	PP
4JC6	141 230 871 0000	00	141 230 851			4.5	0	330	330	14	1.6	B9A	P
4JD6	141 230 871 0000	00	141 230 641			4.5	0	125	125	15	14	B9A	P
4JK6	412 387 100 0000	00	412 365 100			3.7	0.9	125	125	11.5	18	B7G	P
4JL6	412 387 100 0000	00	412 365 100			3.7	0.9	125	60	12.5	15.5	B7G	P
4K30	842 300 000 0000	00	642 300 000			4	10	150		20	3.6	B4	T
4K32	842 300 000 0000	00	642 300 000			4	15	200		30	3.6	B4	T
4K50	842 300 000 0000	00	642 300 000			4	20	200		60	5	B4	T
4K60	842 300 000 0000	00	642 300 000			4	20	300		60	3.5	B4	T
4K61	842 300 000 0000	00	642 300 000			4		300			3	B4	T
4K100	842 300 000 0000	00	642 300 000			4	3	300	200	50	4	B4	T
4KE8	047 230 100 0000	-	045 230 000			4.5	0	125	125	10	12	B9A	PT
4KF8	170 231 481 0000	00	150 231 461			4.2	1	150	150	4	1	B9A	PP
4KF8	178 231 501 0000	00	156 231 401			4.2	1	150	150	4	1	B9A	PP
4KT6	800 230 014 0000	00	800 000 014			4.5	0	330	330	17.0	18	B9A	P
4L11	842 300 000 0000	00	642 300 000			4		150		7	1.4	B4	T
4L12	842 300 000 0000	00	642 300 000			4		150		9	2	B4	T
4L13	842 300 000 0000	00	642 300 000			4		200		8	2	B4	T
4L13A	842 300 000 0000	00	642 300 000			4	11	200		14	2.5	B4	T
4L14	842 300 000 0000	00	642 300 000			4		200		10	2.2	B4	T
4L15	842 300 000 0000	00	642 300 000			4		100			2.2	B4	T
4L16	842 300 000 0000	00	642 300 000			4	8	150		100	2.2	B4	T
4L20	842 300 000 0000	00	642 300 000			2		100			1.4	B4	T
4L28	842 300 000 0000	00	642 300 000			4	4	150		10.5	4	B4	T
4L29	842 300 000 0000	00	642 300 000			4	8	150		20	3.6	B4	T
4LJ8	481 230 010 0000	-	461 230 010			4.3	0	280	0	12	8.0	B9A	PP
4LJ8	000 238 714 0000	-	000 236 514			4.3	0	280	125	13.0	13.0	B9A	PP
4LMBT	842 310 000 0000	00	642 310 000			4	1	200		3.4	2.6	B5	T
4MBT	842 310 000 0000	00	642 310 000			4	1	200		3.4	2.6	B5	T
4MP12	412 387 400 0000	00	412 365 400			4	6	200	175	25	5.5	B7G	P
4N08	842 300 000 0000	00	642 300 000			4		100		8	1.2	B4	T

SPEC.	VALVE TYPE NUMBER	PIN CONNECTIONS				CHARACTERISTICS						BASE	VALVE CLASS
		VCM163 Tester Only		CT160, VT160, VCM Mk 1,2,3,4		Vh	Vg1	Va	Vg2	la	gm mA/V		
		SELECTOR SWITCH	TOP CAP	SELECTOR SWITCH	TOP CAP	V	V	V	V	mA	†Ra MΩ		
	4N100	842 310 000 0000	00	642 310 000		4		150			3.5	B5	T
	4N110	842 310 000 0000	00	642 310 000		4		200		5	1.5	B5	T
	4NG	9X2 300 000 0000	00	892 300 000		4				30		B4	RR
	4P25	842 300 000 0000	70	642 300 000	G2	4	19	250	150	12	1.3	B4	P
	4R-HH2	751 238 410 0000	00	741 236 410		4.2	1	90		8.5	8	B9A	TT
	4R-HH8	841 238 510 0000	00	641 237 410		4.2	1	100		16	16	B9A	TT
	4R-HH9	841 238 510 0000	00	641 237 410		4.2		90		16	16	B9A	TT
	4S	29X 130 000 0000	00	289 130 000		2.5						UX5	DD
	4S-09	742 300 000 0000	80	542 300 000	A1	4	1	200	100	4.5	0.9	B4	P
	4S120	742 310 000 0000	80	542 310 000	A1	4	2	200	60	4	0.5	B5	P
	4S121	742 310 000 0000	80	542 310 000	A1	4		200	100	6	1	B5	P
	4S126	742 310 000 0000	80	542 310 000	A1	4	2	200	100	3	2	B5	P
	4T1	842 314 800 0000	00	642 314 600		4.7	2.3	80		16	6.6	B7G	T
	4THA	847 231 800 0000	40	645 231 700	G1	4	5	100		1.5	1.5	B7	TH
	4THA	847 231 800 0000	40	645 231 700	G1	4	2	250	100	3.5	2.5	B7	TH
	4TP	548 231 700 0000	80	446 231 500	A2	4	5	150	150	16	4.5	B7	TP
	4TPB	081 321 700 0000	40	061 321 500	G1	4	3	250	150	12	8	B7	P
	4TSA	047 231 800 0000	80	045 231 600	A1	4		250	100	5	1.6	B7	P
	4TSP	041 231 700 0000	80	041 231 500	A1	4	3	250	150	12	8	B7	P
	4U130	843 210 000 0000	00	643 210 000		3.5		100			2.8	B5	T
	4W08	842 300 000 0000	00	642 300 000		4		150		4	1.5	B4	T
	4W100	842 310 000 0000	00	642 310 000		4		200		1.5	3.5	B5	T
	4W120	842 310 000 0000	00	642 310 000		4		200		2	0.7	B5	T
	4W200	842 310 000 0000	00	642 310 000		4		150			3.3	B5	T
	4X150A	712 101 314 0000	80	512 1*1 314	A1	6.3	30	250	200	32	4.0	B9G	P
	4XP	842 300 000 0000	00	642 300 000		4	28.5	250			5	B4	T
	4Z60A	023 090 0X0 0000	00	023 080 090		4					30	F8	RR
	5A6	801 227 413 0000	00	601 225 413		2.5	15	150	150	20		B9A	P
	5A/102D	028 710 310 0000	40	026 510 310	G1	7.5	18	200	150	42	2.5	AO8	P
	5A/136D	028 710 310 0000	40	026 510 310	G1	7.5	5.5	250	150	5.2	2	AO8	P
	5A/137D	028 710 310 0000	40	026 510 310	G1	6.3	2	250	100	1.8		AO8	P
	5A/150A	287 113 000 0000	40	265 113 000	G1	10	5.5	250	150	5.2	2	UX6	P
	5A/152M	287 104 130 0000	00	265 104 130		6.3	2	250	150	10	7.5	B8B	P
	5A/155M	278 101 403 0000	00	256 101 403		6.3	2	250	250		6.5	B9G	P
	5A/156M	287 114 113 0000	00	265 114 113		6.3	1.7	250	250	10	7.7	B9G	P
	5A/157D	018 710 310 0000	40	026 510 310	G1	6.3	2	250	100		1.8	AO8	P
	5A/163K	141 238 117 0000	00	141 236 115		6.3	1.5	200	200	15	15	B9A	P
	5A/170K	141 230 817 0000	00	141 230 615		6.3	1.5	200	150	13	16.3	B9A	P
	5A/171G	102 713 410 0000	80	102 513 410	A1	6.3	5	100	100	20	2.7	B8D	P
	5A/180M	287 114 130 0000	00	365 114 130		6.3	1	200	150	26	32	B8G	P
	5A/189KY	412 381 700 0000	00	412 361 500		6.3	2	250	250	10	7.6	B7G	P
	5A/201K	412 381 970 0000	00	412 361 500		6.3	3.3	200	200	7.1	4	B7G	DP
	5A/206K	*41 23* 876 0000	00	*41 23* 678		6.3	2.0	200	115	10.0	8.4	B9A	P
	5A/210K	412 381 700 0000	00	412 361 500		6.3	5	100	100	12.5	4	B7G	P
	5A/220K	801 227 413 0000	00	601 225 413		5	10	150	150	28	4.4	B9A	P
	5AM8	147 238 191 0000	00	145 236 181		4.7	1.7	200	150	11.5	7.0	B9A	DP
	5AN8	841 238 751 0000	00	641 237 541		5	6	200		13	3.3	B9A	TP
	5AN8	841 238 751 0000	00	641 237 541		5	2.2	200	150	9.5	6.2	B9A	TP
	5AQ5	412 387 400 0000	00	412 365 400		5	12.5	250	250	45.0	4.1	B7G	P
	5AR4	030 90X 020 0000	00	*30 809 020		5				120		AO8	RR

SPEC.	VALVE TYPE NUMBER	PIN CONNECTIONS				CHARACTERISTICS						BASE	VALVE CLASS
		VCM163 Tester Only		CT160, VT160, VCM Mk 1,2,3,4		Vh	Vg1	Va	Vg2	la	gm mA/V		
		SELECTOR SWITCH	TOP CAP	SELECTOR SWITCH	TOP CAP	V	V	V	V	mA	†Ra MΩ		
	5AS4	030 X09 020 0000	00	030 908 020		5				120		AO8	RR
	5AS8	741 239 118 0000	00	541 238 116		5	2.2	200	150	9.5	6.2	B9A	DP
	5AT4	030 90X 020 0000	00	030 809 020		5.0						AO8	RR
	5AT8	481 238 715 0000	00	461 237 514		5	1	100		8.5	5.8	B9A	TP
	5AU4	920 90X 030 0000	00	020 809 030		5	1.8	250	150	7.7	4.6	AO8	RR
	5AU4	920 90X 030 0000	00	020 809 030		5				180		AO8	RR
	5AV8	148 235 178 0000	00	146 234 157		5	6	200		13	3.3	B9A	TP
	5AV8	148 235 178 0000	00	146 234 157		5	2.2	200	150	9.5	6.2	B9A	TP
	5AW4	020 90X 030 0000	00	020 809 030		5				120		AO8	RR
	5AX4	020 90X 030 0000	00	020 809 030		5				60		AO8	RR
	5AZ3	299 0XX 990 9930	00	-		5				120		A12	RR
	5AZ4	020 90X 030 0000	00	020 809 030		5				60		B8B	RR
	5B1	742 300 000 0000	80	542 300 000	A1	2	1	150	90	2	1.4	B9A	P
	5B8	148 235 178 0000	00	146 234 157		5	6	200		13	3.3	B9A	TP
	5B8	148 235 178 0000	00	146 234 157		5	1.8	200	150	9.5	6.3	B9A	TP
	5B/104D	028 740 310 0000	00	026 540 310		24	2	24	24	3	3	AO8	T
	5B/110M	287 104 130 0000	00	265 104 130		6.3	6	250	150	38	6.5	B8B	P
	5B/152D	320 704 210 0000	80	320 504 210	A1	6.3	30	400	300	50	5.5	AO8	P
	5B/250A	274 130 000 0000	80	254 130 000	A1	6.3	12.5	400	250	83	6.3	UX5	P
	5B/251M	217 044 130 0000	80	215 044 130	A1	6.3	15	250	250	72	6	B8B	P
	5B/252M	287 044 130 0000	00	265 044 130		6.3	15	250	250	72	6	B8B	P
	5B/253M	287 044 130 0000	00	265 044 130		19	15	150	250	72	6	B8B	P
	5B/254M	217 144 130 0000	80	215 144 130	A1	6.3	20	300	250	50	5.6	B8B	P
	5B/255M	287 144 130 0000	00	265 144 130		6.3	20	300	250	50	5.6	B8B	P
	5B/256M	217 144 130 0000	80	215 144 130	A1	19	20	300	250	50	5.6	B8B	P
	5B/257M	287 144 130 0000	00	265 144 130		12	20	300	250	50	5.6	B8B	P
	5B258M	217 144 130 0000	80	215 144 130	A1	19	14	250	250	72	6	B8B	P
	5B/280D	028 741 310 0000	00	*26 541 310		6.3	60	400	300	100	6.3	AO8	P
	5B/351D	020 740 310 0000	80	020 540 310	A1	6.3	10	150	150	200	14	AO8	P
	5B/354D	038 741 210 0000	00	*36 541 210		6.3	20	300	150	90	10	AO8	P
	5B/355D	030 740 210 0000	80	*30 540 210	A1	6.3	10	150	150	200	14	AO8	P
	5B/900A	204 178 300 0000	00	2*4 156 300		26	14	150	150	500	35	B7A	T
	5B/901A	204 178 300 0000	00	2*4 156 300		26	30	150	150	500	25	B7A	P
	5BC3	203 0X0 009 0000	00	2*3 *9* **8		5				120		B9B	RR
	5BC3A	203 0XX 099 0000	00	203 087 099		5.0		40		200			RR
	5BE8	481 238 715 0000	00	461 237 514		4	1	150		18	8.5	B9A	TP
	5BE8	481 238 715 0000	00	461 237 514		4	1	250	100	10	5.2	B9A	TP
	5BK7	851 238 411 0000	00	741 236 411		5	2	150		10.7	9.3	B9A	TT
	5BQ7	851 238 410 0000	00	741 236 410		5.6	2	150		9	6.4	B9A	TT
	5BR8	481 238 715 0000	00	461 237 514		5	1	150		18	8.5	B9A	TP
	5BR8	481 238 715 0000	00	461 237 514		5	0.9	250	100	10	5.2	B9A	TP
	5BS8	841 238 510 0000	00	641 237 410		5.6		150		10	7.2	B9A	TT
	5BT8	X91 238 741 0000	00	981 236 541		4.7	2.2	200	150	9.5	6.2	B9A	DDP
	5BW8	X19 234 178 0000	00	918 234 156		4.7	1.1	250	100	10	5.2	B9A	DDP
	5BZ7	841 238 510 0000	00	741 236 410		5.6	2.2	150		10	6.8	B9A	TT
	5CG4	030 90X 020 0000	00	030 809 020		5				60		AO8	RR
	5CG8	481 238 715 0000	00	461 237 514		4.7	0.9	100		8.5	5.8	B7G	TP
	5CG8	481 238 715 0000	00	461 237 514		4.7	1.9	250	150	7.7	4.6	B7G	TP
	5CL8	481 238 715 0000	00	461 237 514		4.7	0.9	150		15	8	B9A	TP
	5CL8	481 238 715 0000	00	461 237 514		4.7	1	150	125	12	5.8	B9A	TP
	5CL8A	481 230 000 0000	00	461 230 000		4.7	1	125	70	14	8.0	B9A	TP
	5CL8A	481 230 000 0000	00	461 230 000		4.7	1	100	125	12	6.5	B9A	TP
	5CM6	704 234 108 0000	00	504 234 106		4.7	12.5	250	250	45	4.1	B9A	P
	5CM8	851 238 714 0000	00	641 237 514		4.7	2	250		1.8	2	B9A	TP
	5CM8	851 238 714 0000	00	641 237 514		4.7	2.2	200	150	9.5	6.2	B9A	TP
	5CQ8	857 238 114 0000	00	645 237 114		4.2	0.8	150	125	15	8	B7G	TP

SPEC.	VALVE TYPE NUMBER	PIN CONNECTIONS				CHARACTERISTICS						BASE	VALVE CLASS
		VCM163 Tester Only		CT160, VT160, VCM Mk 1,2,3,4		Vh	Vg1	Va	Vg2	la	gm mA/V		
		SELECTOR SWITCH	TOP CAP	SELECTOR SWITCH	TOP CAP	V	V	V	V	mA	†Ra MΩ		
	5CQ8	857 238 114 0000	00	645 237 114		4.2	1	150		12	5.8	B7G	TP
	5CR8	851 238 714 0000	00	641 237 514		4.7	2	125		12	4	B9A	TP
	5CR8	851 238 714 0000	00	641 237 514		4.7	1	125	125	13	7.7	B9A	TP
	5CU4	190 90X 030 0000	00	120 809 030		5				180		AO8	RR
	5CZ5	704 234 108 0000	00	504 234 1*6		45	6.7	100	100	43	9	B9A	P
	5DH8	481 238 715 0000	00	461 237 514		5.2	2.5	250		7	4.4	B9A	TP
	5DH8	481 238 715 0000	00	461 237 514		5.2	1	150	125	13	8.6	B9A	TP
	5DJ4	229 9XX 330 0000	00	228 899 330		5.0				120		AO8	RR
	5DN4	229 9XX 330 0000	00	228 899 330		5				120		AO8	RR
	5E255	842 370 000 0000	00	642 350 000		2	4.5	150	150	9.5	2.5	B5	P
	5E415	842 370 000 0000	00	642 350 000		4	25	300	200	20	1.7	B5	P
	5EA8	857 238 114 0000	00	645 237 114		4.7	1	150		18	8.5	B9A	TP
	5EA8	857 238 114 0000	00	645 237 114		4.7	1	150	125	12	6.4	B9A	TP
	5EH8	148 231 578 0000	00	146 231 457		4.7	1	150		13.5	7.5	B9A	TP
	5EH8	148 231 578 0000	00	146 231 457		4.7	1	150	125	12	6	B9A	TP
	5ES8	841 238 510 0000	00	641 237 410		5.6	1.2	90		15	12.5	B9A	TT
	5EU8	848 231 517 0000	00	746 231 415		4.7	1	150		18	8.5	B9A	TP
	5EU8	848 231 517 0000	00	746 231 415		4.7	1	150	125	12	6.4	B9A	TP
	5EW6	412 387 100 0000	00	412 365 100		5.6	0.8	150	125	11	14	B7G	P
	5FC7	148 235 118 0000	00	146 234 117		5.1	1.2	100		15	12.3	B9A	TT
	5FG7	481 238 715 0000	00	461 237 514		4.7	1	150		13	7.5	B9A	TP
	5FG7	481 238 715 0000	00	461 237 514		4.7	1	150	125	11	6	B9A	TP
	5FV8	481 238 715 0000	00	461 237 514		4.7	1	150		14	8	B9A	TP
	5FV8	481 238 715 0000	00	461 237 514		4.7	1	150	125	12	6.5	B9A	TP
	5GK18	020 90X 030 0000	00	020 809 030		5						AO8	RR
	5GK20	030 90X 020 0000	00	030 809 020		5				120		AO8	RR
	5GK22	030 90X 020 0000	00	030 809 020		5						AO8	RR
	5GK24	030 90X 020 0000	00	030 809 020		5				120		AO8	RR
	5GH8	857 238 114 0000	00	645 237 114		4.7	1	150		13	8.5	B9A	TP
	5GH8	857 238 114 0000	00	645 237 114		4.7	1	150	125	12	7.5	B9A	TP
	5GH8A	800 230 014 0000	00	000 230 014		4.7	1	125		13.5	8.5	B9A	PT
	5GH8A	047 328 100 0000	00	045 230 014		4.7	1	125	125	12.0	7.5	B9A	PT
	5GM6	412 387 000 0000	00	412 365 000		5.6	56	150	150	14	13	B7G	P
	5GX6	412 387 100 0000	00	412 365 100		4.7	1	150	100	3.7	3.7	B7G	P
	5GX7	151 238 784 0000	00	141 236 574		5.6	1	125		13	8.5	B9A	TP
	5GX7	151 238 784 0000	00	141 236 574		5.6	1	125	125	8	11	B9A	TP
	5HA7	281 100 005 8430	00	261 100 004		5.6	8.5	250		10.5	22	A12	TT
	5HA7	281 100 005 8430	00	261 100 004		5.6	2	250		1.2	1.6	A12	TT
	5H26	412 387 100 0000	00	412 365 100		6.3		150	100	3.2		B7G	P
	5HB7	151 238 784 0000	00	141 237 654		4.7	1	150		18	8.5	B9A	TP
	5HB7	151 238 784 0000	00	141 237 654		4.7	1.2	175	150	10	12	B9A	TP
	5HG8	151 234 887 0000	00	141 234 675		5.3	3	100		14	5.5	B9A	TP
	5HG8	151 234 887 0000	00	141 234 675		5.3	1.2	175	150	10	12	B9A	TP
	5J6	882 345 100 0000	00	672 344 100		5	0.8	100		8.5	5.3	B7G	TT
	5J6	882 345 100 0000	00	672 344 100		5	3	150		5	4.5	B7G	TT
	5JK6	412 387 100 0000	00	412 365 100		4.9	0.9	125	125	11.5	18	B7G	P
	5JL6	412 387 100 0000	00	645 365 100		4.9	0.9	125	60	12.5	15.5	B7G	P
	5KD8	857 238 114 0000	00	645 237 114		5.6	1	125		13.5	7.5	B9A	TP
	5KE8	857 238 114 0000	00	645 237 114		5.6	1	125		13	8	B9A	TP
	5KE8	857 238 114 0000	00	645 237 114		5.6	0.4	125	125	10	12	B9A	TP
	5KZ8	851 238 715 0000	00	641 237 514		4.7	1	125		13.5	8.5	B9A	TP
	5KZ8	851 238 715 0000	00	641 237 514		4.7	1	125	125	12.0	7.5	B9A	TP
	5LJ8	481 238 715 0000	00	461 237 514		5.6	0.7	125		13	8	B9A	TP
	5LJ8	481 238 715 0000	00	461 237 514		5.6	0.5	125	125	12	13	B9A	TP
	5MB8	481 238 715 0000	00	461 237 514		5.6	0.7	125		13	8	B9A	TP
	5MB8	481 238 715 0000	00	461 237 514		5.6	0.4	125	125	10	12	B9A	TP

SPEC.	VALVE TYPE NUMBER	PIN CONNECTIONS				CHARACTERISTICS						BASE	VALVE CLASS
		VCM163 Tester Only		CT160, VT160, VCM Mk 1,2,3,4		Vh	Vg1	Va	Vg2	la	gm mA/V		
		SELECTOR SWITCH	TOP CAP	SELECTOR SWITCH	TOP CAP	V	V	V	V	mA	†Ra MΩ		
	5MK9	002 390 000 0000	00	002 380 000		5				60		B7G	R
	5MHH3	882 345 100 0000	00	672 344 100		4.7	1	100		11	7.5	B7G	TT
	5M-HH3	142 380 100 0000	00	142 360 100		4.7	1	100		11	7.5	B7G	T
	5MQ8	800 230 014 0000	00	00 230 014		5.6	0	330		18	8.5	9AE	TP
	5MQ8	800 230 014 0000	00	00 230 014		5.6	0	330	125	12	10	9AE	TP
	5P29	120 740 310 0000	80	120 540 310	A1	6.3	7	250	250	100	14.3	AO8	P
	5Q5	038 740 320 0000	00	036 540 320		1.4	4.6	90	90	4.5	2	AO8	P
	5R4	020 90X 030 0000	00	020 809 030		5(5.7)				60		AO8	RR
	5R4GV	020 90X 030 0000	00	020 809 030		5(5.7)				60			-
	5RDDH1	X11 239 841 0000	00	911 238 641		4.7	2	250		1.6	1.6	B9A	DDT
	5RHH5	841 228 513 0000	00	641 227 413		4.6	1	100		0.6	0.3	B9A	TT
	5RK16	900 230 0X0 0000	00	800 230 090		5				120		B9A	RR
	5T4	020 90X 030 0000	00	020 809 030		5				120		AO8	RR
	5T4A	041 231 700 0000	80	041 231 500	A1	4	4.5	250	150	4.5	1.7	B7	P
	5T8	9X1 23Y 148 0000	00	*91 238 146		5	3	250		1.0	1.2	B9A	DDDT
	5U4	020 90X 030 0000	00	020 809 030		5(5.7)				120		AO8	RR
	5U4-GA	020 X09 030 0000	00	020 908 030		5.0		750		525		B5-15	RR
	5U8	857 238 114 0000	00	645 237 114		5	1	150		18	8.5	B9A	TP
	5U8	857 238 114 0000	00	645 237 114		5	1	250	100	10	5.2	B9A	TP
	5V3	020 90X 030 0000	00	020 809 030		5				120		AO8	RR
	5V4	030 90X 020 0000	00	030 809 020		5(5.7)				60		AO8	RR
	5V6	028 740 310 0000	00	026 540 310		4.7	12.5	250	250	45	4.1	AO8	P
	5W4	020 90X 030 0000	00	020 809 030		5				60		AO8	RR
	5X3	29X 300 000 0000	00	289 300 000		5				15		AO8	RR
	5X4	009 0X0 230 0000	00	008 090 230		5				120		AO8	RR
	5X8	148 231 578 0000	00	146 231 457		5	1	100		8.5	5.8	B9A	TP
	5X8	148 231 578 0000	00	146 231 457		5	1.8	250	150	7.7	4.6	B9A	TP
	5Y3	020 90X 030 0000	00	020 809 030		5				60		AO8	RR
	5Y3GB	030 90X 020 0000	00	030 809 020		5(5.7)				60		AO8	RR
	5Y3GR	020 90X 030 0000	00	020 809 030		5(5.7)				60		AO8	RR
	5Y3GT	020 90X 030 0000	00	020 809 030		5(5.7)				60		AO8	RR
	5Y4	009 0X0 230 0000	00	008 090 230		5				60		AO8	RR
	5Y4SG	009 0X0 230 0000	00	008 090 230		5				60		AO8	RR
	5Z3	29X 300 000 0000	00	289 300 000		5(5.7)				120		UX4	RR
	5Z4	030 90X 020 0000	00	030 809 020		5(5.7)				60		AO8	RR
	5Z4G	030 90X 020 0000	00	030 809 020		5(5.7)				60		AO8	RR
	5Z10	020 X09 030 0000	00	020 908 030		5				120		B8A	RR
	6/30L2	851 238 410 0000	00	741 236 410		6.3	7.9	200		10	3.4	B9A	TT
	6A3	284 300 000 0000	00	264 300 000		6.3	36	250		60	5.25	UX4	T
	6A4	284 730 000 0000	00	264 530 000		6.3	9	150	150	14	1.9	UX5	P
	6A5	028 040 310 0000	00	026 040 310		6.3	45	250		60	5.25	AO8	T
	6A6	285 148 300 0000	00	274 146 300		6.3	5	250		3.0	1.6	UX7	TT
	6A7	287 741 300 0000	40	265 541 300	G1	6.3	8	250	100	3.5	1.1	Sm7	H
	6A8	028 747 310 0000	40	026 545 310	G1	6.3	8	250	100	3.5	1.1	AO8	H
	6A10C	028 741 340 0000	00	026 541 340		6.3		250	100	3.5		AO8	H
	6AB4	802 304 100 0000	00	602 304 100		6.3	2	250		10	5.5	B7G	T
	6AB5	284 713 000 0000	00	264 513 000		6.3	15.5	150	150	0.1	†1.0MΩ	UX6	TI
	6AB7	021 417 380 0000	00	021 415 360		6.3	3	300	200	12.5	5	AO8	P
	6AB8	841 238 175 0000	00	641 237 154		6.3	2	100		4	1.4	B9A	TP
	6AB8	841 238 175 0000	00	641 237 154		6.3	8	200	200	17.5	3.5	B9A	TP
	6AC5	028 040 310 0000	00	026 040 310		6.3	0	250		2.5		AO8	T

SPEC.	VALVE TYPE NUMBER	PIN CONNECTIONS				CHARACTERISTICS						BASE	VALVE CLASS
		VCM163 Tester Only		CT160, VT160, VCM Mk 1,2,3,4		Vh	Vg1	Va	Vg2	la	gm mA/V		
		SELECTOR SWITCH	TOP CAP	SELECTOR SWITCH	TOP CAP	V	V	V	V	mA	†Ra MΩ		
	6AC6	020 840 310 0000	00	026 740 310		6.3	2	300	150	10	9	AO8	P
	6AC6	028 050 310 0000	00	026 740 310		6.3	2	300	150	10	9	AO8	P
	6AC7	021 417 380 0000	00	021 415 360		6.3	2	300					-
	6AC9	2X1 100 114 7830	00	-		6.3	1	125	125	12	10	A12	DDP
	6AD4	402 013 080 0000	00	402 013 080		6.3	11.5	100		1.4	2	B8B	T
	6AD5	028 040 310 0000	00	026 040 310		6.3	1	250		0.9	1.5	AO8	T
	6AD6	028 740 310 0000	00	026 540 310		6.3	3	150				AO8	TI
	6AD6	028 740 310 0000	00	026 540 310		6.3	50	150	150			AO8	TI
	6AD7	428 758 310 0000	00	427 546 310		6.3	25	250		4	0.3	AO8	TP
	6AD7	428 758 310 0000	00	427 546 310		6.3	16.5	250	250	34	2.5	AO8	TP
	6AD8	741 238 9X1 0000	00	541 236 891		6.3	2.0	250	90	6.7	1.1	B9A	DDP
	6AE4	028 040 310 0000	00	026 040 310		6.3	15	100		7	1.2	AO8	T
	6AE5	028 040 310 0000	00	026 040 310		6.3	15	100		7	1.2	AO8	T
	6AE6	020 840 310 0000	00	026 740 310		6.3	1.5	250		6.5	1	AO8	TT
	6AE6	028 050 310 0000	00	026 740 310		6.3	1.5	250		6.5	1	AO8	TT
	6AE7	028 415 310 0000	00	026 414 310		6.3	13.5	250		10	3	AO8	TT
	6AE8	051 230 480 0000	00	541 237 46*		6.3	2	100		5.2	2.2	B9A	TH
	6AE8	751 238 500 0000	00	541 237 46*		6.3	2	250	90	3.5		B9A	TH
	6AF3	000 230 009 0000	10	*** 23* **8	C	6.3				120		B9A	R
	6AF4	842 314 800 0000	00	642 314 600		6.3	4	100		15	6.6	B7G	T
	6AF4A	842 314 800 0000	00	642 314 600		6.3	3	100		20	7.5	B7G	T
	6AF5	028 040 310 0000	00	026 040 310		6.3	18	200		7	1.5	AO8	T
	6AF6	028 740 310 0000	00	026 540 310		6.3	81	150	125			AO8	TI
	6AF7	028 470 310 0000	00	026 457 310		6.3	45	200	200	0.16	†1	AO8	TI
	6AF7	020 478 310 0000	00	026 457 310		6.3	15	200	200	0.15	†1	AO8	TI
	6AF11	285 814 181 7630	00	-		6.3	2	200		7	5.5	A12	TTP
	6AF11	285 814 181 7630	00	-		6.3	2	200		9.2	4.4	A12	TTP
	6AF11	285 814 181 7630	00	-			3	200	150	24	11	A12	TTP
	6AG5	412 387 100 0000	00	412 365 100		6.3	1.5	250	150	6.5	5	B7G	P
	6AG6	028 740 310 0000	00	026 540 310		6.3	6	250	250	32	10	AO8	P
	6AG7	120 417 380 0000	00	120 415 360		6.3	3	300	150	30	11	AO8	P
	6AG11	219 148 851 X130	00	218 146 641		6.3	1	125		7.5	7.8	A12	DDTT
	6AH4	420 080 310 0000	00	420 060 310		6.3	23	250		30	4.5	AO8	T
	6AH5	720 804 310 0000	00	520 604 310		6.3	18	350	250	54	5.2	AO8	P
	6AH6	412 387 100 0000	00	412 365 100		6.3	2	300	150	10	9	B7G	P
	6AH7	518 148 230 0000	00	417 146 230		6.3	9	250		12	2.4	AO8	TT
	6AH9	248 100 000 0030	00	-		6.3	9	250	128	8.0	2.75	A12	PT
	6AH9	248 100 000 0030	00	-		6.3	9	250	150	25.0	21	A12	PT
	6AJ4	414 484 234 0000	00	414 464 234		6.3	2	125		8	7	B9A	T
	6AJ5	412 387 100 0000	00	412 365 100		6.3	7.5	200	175	2.9	2.7	B7G	P
	6AJ7	020 417 380 0000	00	020 415 360		6.3		300	150	10	9	AO8	P
	6AJ8	751 238 084 0000	00	541 237 164		6.3	3	100		5	2.3	B9A	TH
	6AJ8	751 238 084 0000	00	541 237 164		6.3	2	250	100	6.5	2.4	B9A	TH
	6AK4	402 013 080 0000	00	402 013 060		6.3	2.5	250		9.5	3.8	B8D	T
	6AK5	412 387 100 0000	00	412 365 100		6.3	3.5	150	150	7	4.3	B7G	P
	6AK6	412 387 100 0000	00	412 365 100		6.3	9	200	175	15	2.3	B7G	P
	6AK7	120 417 380 0000	00	120 415 360		6.3	3	300	150	30	11	AO8	P
	6AK8	Y91 23X 148 0000	00	†91 238 146		6.3	3	250		1.0	1.2	B9A	DDDT
	6AL3	000 230 009 0000	10	*** 23* **8	C	6.3						B9A	D
	6AL5	1X2 310 900 0000	00	192 310 800		6.3						B7G	DD
	6AL6	020 740 310 0000	80	020 540 310	A1	6.3	14	250	250	72	6	AO8	P



SPEC.	VALVE TYPE NUMBER	PIN CONNECTIONS				CHARACTERISTICS						BASE	VALVE CLASS
		VCM163 Tester Only		CT160, VT160, VCM Mk 1,2,3,4		Vh	Vg1	Va	Vg2	la	gm mA/V		
		SELECTOR SWITCH	TOP CAP	SELECTOR SWITCH	TOP CAP	V	V	V	V	mA	†Ra MΩ		
	6AL11	215 118 741 7830	00	-		6.3	2	15	100	1.3	1	A12	PP
	6AM4	414 484 234 0000	00	414 464 234		6.3	1	200		10	9.8	B9A	T
	6AM5	412 380 700 0000	00	412 360 500		6.3	13.5	250	250	16	2.6	B7G	P
ξ	6AM6	412 381 700 0000	00	412 361 500		6.3	2	250	250	10	7.5	B7G	P
ξ	6AM6	412 381 700 0000	00	412 361 500		6.3	1.5	200	150	4	6.4	B7G	P
	6AM8	147 238 191 0000	00	145 236 181		6.3	1.7	200	150	11.5	7	B9A	DP
	6AN4	842 314 800 0000	00	642 314 600		6.3	1.3	200		13	10	B7G	T
	6AN5	412 387 100 0000	00	412 365 100		6.3	6	150	125	35	8	B7G	P
	6AN6	29X Y21 300 0000	00	289 ††1 300		6.3						B7G	DDDD
	6AN7	051 230 084 0000	00	541 230 764		6.3	2	100		5	2	B9A	TP
	6AN7	751 230 805 0000	00	541 230 764		6.3	2	250	100	3	0.7	B9A	TP
	6AN8	841 238 751 0000	00	641 237 541		6.3	6	200		13	3.3	B9A	TP
	6AN8	841 238 751 0000	00	641 237 541		6.3	2.2	200	150	9.5	6.2	B9A	TP
	6AQ4	412 314 800 0000	00	412 314 600		6.3	2	250		6	8.5	B7G	T
	6AQ5	412 387 400 0000	00	412 365 400		6.3	12.5	250	250	45	4.1	B7G	P
	6AQ6	412 39X 800 0000	00	412 398 600		6.3	3	250		1.0	1.2	B7G	DDT
	6AQ7	91X 481 230 0000	00	918 461 230		6.3	2	250		2.3	1.6	AO8	DDT
	6AQ8	851 238 410 0000	00	741 236 410		6.3	2.3	250		10	5.5	B9A	TT
	6AR5	412 387 000 0000	00	412 365 000		6.3	16	250	250	34	2.4	B7G	P
	6AR6	108 072 430 0000	00	106 052 430		6.3	36	300	300	58	4.3	AO8	P
	6AR7	481 9X1 230 0000	00	461 891 230		6.3	2	250		1.3	1	AO8	DDT
	6AR7GT	208 7X9 130 0000	40	206 598 130	G1	6.3	2	250	100	7	2.5	AO8	DDP
	6AR8	117 324 188 0000	00	115 324 166		6.3	3	250	250	10	4	B9A	P
	6AR11	287 151 187 4130	00	-		6.3	0.7	125	125	11	10.5	A12	PP
	6AS4	001 090 230 0000	00	001 080 230		6.3						AO8	R
	6AS5	142 347 800 0000	00	142 345 600		6.3	8.5	150	125	35	5.6	B7G	P
	6AS6	412 387 100 0000	00	412 365 100		6.3	2	150	125	5.5	3.5	B7G	P
	6AS7	501 481 230 0000	00	471 461 230		6.3	40	100		50	7	AO8	TT
	6AS7	581 401 230 0000	00	471 461 230		6.3	40	100		50	7	AO8	TT
	6AS8	741 239 118 0000	00	541 238 116		6.3	2.2	200	150	9.5	6.2	B9A	DP
	6AS11	285 814 181 7630	00	-		6.3	2	200		7	5.5	A12	TTP
	6AS11	285 814 181 7630	00	-		6.3	2	200		9.2	4.4	A12	TTP
	6AS11	285 814 181 7630	00	-		6.3	2	200	125	24	10.5	A12	TTP
	6AT6	412 39X 800 0000	00	412 389 600		6.3	3	250		1	1.2	B7G	DDT
	6AT7	851 228 413 0000	00	641 237 410		6.3	2	250		10	5.5	B9A	TT
	6AT7	851 228 413 0000	00	641 237 410		6.3	1	100		3.7	4	B9A	TT
	6AT8	481 238 715 0000	00	461 237 514		6.3	1	100		8.5	5.8	B9A	TP
	6AT8	481 238 715 0000	00	461 237 514		6.3	1.8	250	150	7.7	4.6	B9A	TP
	6AU4	001 090 230 0000	00	001 080 230		6.3				120		AO8	R
	6AU5	421 080 370 0000	00	421 060 350		6.3	20	200	150	50	5.6	AO8	P
	6AU6	412 387 100 0000	00	412 365 100		6.3	1	250	150	10	5.2	B7G	P
	6AU7	841 228 513 0000	00	641 227 413		3	8.5	250		10	2.2	B9A	TT
	6AU8	148 231 578 0000	00	146 213 457		6.3	1.2	150		8.5	4.8	B9A	TP
	6AU8	148 231 578 0000	00	146 213 457		6.3	1.5	200	125	15	7	B9A	TP
	6AV4	902 30X 100 0000	00	802 309 100		6.3				30		B7G	RR
	6AV5	421 080 370 0000	00	421 060 350		6.3	22.5	250	150	57	5.9	AO8	P
	6AV6	412 39X 800 0000	00	412 389 600		6.3	2	250		1.2	1.6	B7G	DDT

SPEC.	VALVE TYPE NUMBER	PIN CONNECTIONS				CHARACTERISTICS						BASE	VALVE CLASS
		VCM163 Tester Only		CT160, VT160, VCM Mk 1,2,3,4		Vh	Vg1	Va	Vg2	la	gm mA/V		
		SELECTOR SWITCH	TOP CAP	SELECTOR SWITCH	TOP CAP	V	V	V	V	mA	†Ra MΩ		
	6AV8	485 231 871 0000	00	464 231 751		6.3	6	200		13	3.3	B9A	TP
	6AV8	485 231 871 0000	00	464 231 751		6.3	2.2	200	150	9.5	6.2	B9A	TP
	6AV11	281 181 504 8630	00	-		6.3	8.5	250		10.5	2.2	A12	TTT
	6AW4	29X 130 000 0000	00	289 130 000		6.3				30		UX5	RR
	6AW5	209 1X0 310 0000	00	208 190 310		6.3				30		AO8	RR
	6AW6	412 387 100 0000	00	412 365 100		6.3	1.8	250	150	7	5	B7G	P
	6AW7	14X 918 230 0000	00	149 816 230		6.3	0	100		1.4	1.2	AO8	DDT
	6AW8	148 231 578 0000	00	146 231 457		6.3	2	200		4	4	B9A	TP
	6AW8	148 231 578 0000	00	146 231 457		6.3	3	200	150	13	9	B9A	TP
	6AX2	230 232 032 0000	90	23* 232 *32	D1	6.3				120		B9A	R
	6AX3	200 900 100 8030	00	-		6.3				120		A12	R
	6AX4	001 090 230 0000	00	001 080 230		6.3				120		AO8	R
	6AX5	02X 090 310 0000	00	029 080 310		6.3				60		AO8	RR
	6AX6	029 1X0 310 0000	00	028 190 310		6.3				120		AO8	RR
	6AX7	841 228 513 0000	00	641 227 413		3	2	250		1.2	1.6	B9A	TT
	6AX8	857 238 114 0000	00	645 237 114		6.3	1	150		18	8.5	B9A	TP
	6AX8	857 238 114 0000	00	645 237 114		6.3	1.2	250	100	10	4.8	B9A	TP
	6AY3	090 230 901 0000	00	*8* 23* 8*1		6.3				120		B9D	R
	6AY5	023 740 310 0000	80	023 540 310	A1	6.3	12.5	250	250	47	4.1	AO8	P
	6AY8	028 79X 310 0000	40	026 589 310	G1	6.3	5	250	100	52	9.5	AO8	DDP
	6AY11	219 158 841 X130	00	-		6.3	2	250		1.2	1.9	B8A	DD
	6AZ5	910 230 1X0 0000	00	810 230 190		6.3						B8A	DD
	6AZ6	093 113 X00 0000	00	083 113 900		6.3						B8A	DD
	6AZ8	871 325 184 0000	00	751 324 164		6.3	6	200		13	3.3	B9A	TP
	6AZ8	871 325 184 0000	00	751 324 164		6.3	2.3	200	150	9.5	6	B9A	TP
	6B2P	472 389 100 0000	00	452 368 100		6.3	3	250	100	6.7	1.85	B7G	P
	6B3	090 230 909 0000	10	080 230 808	C	6.3						B9A	D
	6B4	028 040 300 0000	00	026 040 300		6.3	45	250		60	5.2	AO8	T
	6B6	028 9X0 310 0000	40	026 890 310	G1	6.3	2	250		0.9	1.1	AO8	DDT
	6B7	289 9X1 300 0000	40	265 891 300	G1	6.3	3	250	150	9	1.1	Sm7	DDP
	6B8	028 X97 310 0000	40	026 985 310	G1	6.3	3	250	150	10	1.3	AO8	DDP
	6B10	215 848 1X1 9030	00	-		6.3	9.5	250		.7	1.8	A12	DDT
	6B11	288 474 130 0000	00	276 454 130		6.3	3	100		5	2.3	B9A	TH
	6B11	288 474 130 0000	00	276 454 130		6.3		150	125	5		B9A	TH
	6B31	921 013 X00 0000	00	821 013 900		6.3						B7G	DD
	6B32	192 310 X00 0000	00	182 311 900		6.3				5		B7G	DD
	6BA3	090 230 901 0000	00	*8* 23* 8*1		6.3				180		B9A	R
	6BA5	402 083 710 0000	00	402 063 510		6.3	2	100	100	5.5	2.1	B8A	P
	6BA6	412 387 100 0000	00	412 365 100		6.3	1	250	100	11	4.4	B7G	P
	6BA7	841 231 108 0000	00	641 231 106		6.3	2	100		18	7.0	B9A	H
	6BA8	148 231 578 0000	00	146 231 457		6.3	8	200		8	2.7	B9A	TP
	6BA8	148 231 578 0000	00	146 231 457		6.3	2.5	200	150	13	9	B9A	TP
	6BA11	2Y7 418 114 1830	00	-		6.3	11	250		5.0	1.8	A12	TPP
	6BA11	2Y7 418 114 1830	00	-		6.3		100	60	1.7	1.7	A12	TPP
	6BB14	441 237 710 0000	80	441 235 51*	A1	6.3	20	150	150	70	10	B9D	P
	6BC4	844 231 448 0000	00	644 231 446		6.3	1.5	150		14.5	10	B8A	T
	6BC5	412 387 100 0000	00	412 365 100		6.3	1.3	250	150	7.5	5.7	B7G	P
	6BC7	190 23X 1Y1 0000	00	180 239 1†1		6.3				5		B9A	DDD
	6BC8	841 238 510 0000	00	741 236 410		6.3	2.2	150		10.0	6.2	B9A	TT
	6BC32	412 39X 800 0000	00	412 389 600		6.3	2	250		1	1.6	B7G	DDT
	6BD5	421 080 370 0000	00	421 060 350		6.3	12	200	200		5	AO8	P
	6BD6	412 387 100 0000	00	412 354 100		6.3	3	250	100	9	2	B7G	P

SPEC.	VALVE TYPE NUMBER	PIN CONNECTIONS				CHARACTERISTICS						BASE	VALVE CLASS
		VCM163 Tester Only		CT160, VT160, VCM Mk 1,2,3,4		Vh	Vg1	Va	Vg2	la	gm mA/V		
		SELECTOR SWITCH	TOP CAP	SELECTOR SWITCH	TOP CAP	V	V	V	V	mA	†Ra MΩ		
	6BD7	841 239 0X0 0000	00	641 238 09*		6.3	3.0	250		1.0	1.2	B9A	DDT
	6BD11	285 814 181 7630	00	-		6.3	11	250		5.0	1.8	A12	TPP
	6BD11	285 814 181 7630	00	-		6.3		100	60		1.7	A12	TPP
	6BE3	200 800 100 0030	00	-		6.3				300		A12	R
	6BE6	112 387 400 0000	00	112 365 400		6.3	1.5	250	100	3	.47	B7G	H
	6BE7	741 238 114 0000	00	541 236 114		6.3	1	250	20	0.95	0.7	B9A	N
	6BE8	481 238 715 0000	00	461 237 514		6.3	1	150		18	8.5	B9A	TP
	6BE8	481 238 715 0000	00	461 237 514		6.3	1	250	100	10	5.2	B9A	TP
	6BF5	412 387 400 0000	00	412 365 400		6.3	7.5	100	100	36	7.5	B7G	P
	6BF6	412 3X9 800 0000	00	412 398 600		6.3	9	250		9.5	1.9	B7G	DDP
	6BF7	842 113 580 0000	00	642 113 470		6.3	0.8	100		8	4.8	B8D	TT
	6BF11	215 017 841 7830	00	-		6.3	6	150	100	38	2.6	A12	PP
	6BF11	215 017 841 7830	00	-		6.3	1.8	150	100	1.3	1	A12	PP
	6BG6	021 040 370 0000	80	021 040 350	A1	6.3	15	250	250	75	6	AO8	P
	6BG7	852 113 480 0000	00	742 113 460		6.3	0.8	100		8	4.8	B9A	TT
	6BH3	090 230 901 0000	00	*8* 23* 8*1		6.3				180		B9D	R
	6BH3A	080 230 801 0000	00	080 230 801		6.3		32		350			R
	6BH5	741 238 000 0000	00	541 236 000		6.3	2.5	250	100	6	1.7	B9A	P
	6BH6	412 385 100 0000	00	412 365 100		6.3	1	250	150	7.4	4.6	B7G	P
	6BH8	148 321 578 0000	00	146 321 457		6.3	5	250		9.5	3.3	B9A	TP
	6BH8	148 321 578 0000	00	146 321 457		6.3	1.6	200	125	15	7	B9A	TP
	6BH11	281 514 867 8130	00	-		6.3	1	125		8.5	13.5	A12	TTP
	6BH11	281 514 867 8130	00	-		6.3	1	125	125	12	7.5	A12	TTP
	6BJ5	412 380 700 0000	00	412 36* 500		6.3	5	250	250	35	10.5	B7G	P
	6BJ6	412 387 100 0000	00	412 365 100		6.3	1	250	100	9.2	3.6	B7G	P
	6BJ7	1Y0 23X 191 0000	00	1†0 239 181		6.3						B9A	DDD
	6BJ8	911 23X 841 0000	00	811 239 641		6.3	9	250		8	2.8	B9A	DDT
	6BK4B	120 040 300 0000	00	120 040 030	A	6.3	7	270000	0	1.6	0.2	B8-71	T
	6BK4B	120 040 300 0000	00	120 040 030	A	6.3	0	270000	40	1.6	0.2	B8-71	T
	6BK5	804 231 470 0000	00	604 231 450		6.3	5	250	250	35	8.5	B9A	P
	6BK6	412 39X 800 0000	00	412 389 600		6.3	2	250		1.2	1.6	B7G	DDT
	6BK7	851 238 410 0000	00	741 236 410		6.3	1.0	100		9	6.1	B9A	TT
	6BK7A	851 238 410 0000	00	741 236 410		6.3	2	150		10.7	9	B9A	TT
	6BK7B	000 230 410 0000	00	000 236 410		6.3	11	150		18	9.3	B9A	TT
	6BK7B	841 230 000 0000	00	841 230 000		6.3	11	150		18	9.3	B9A	TT
	6BK8	701 238 014 0000	00	501 236 014		6.3		150	150	3	1.8	B9A	P
	6BL4	001 090 230 0000	00	**1 *8* 230		6.3				180		AO8	R
	6BL7	581 481 230 0000	00	471 461 230		6.3	9	250		40	7	AO8	TT
	6BL8	857 238 114 0000	00	645 237 114		6.3	2	100		14	5	B9A	TP
	6BL8	857 238 114 0000	00	645 237 114		6.3	2	200	175	10	6.2	B9A	TP
	6BM5	412 387 400 0000	00	412 365 400		6.3	6	250	250	30	7	B9A	P
	6BM8	415 238 718 0000	00	414 237 516		6.3	1	200		3.7	2.5	B9A	TP
	6BM8	415 238 718 0000	00	414 237 516		6.3	16	200	200	35	6.4	B9A	TP
	6BN4	142 381 400 0000	00	142 361 400		6.3	2.2	150		9	7	B7G	T
	6BN4A	142 381 000 0000	-	142 361 400		6.3	6	150		9	7.7	B7G	T
	6BN5	441 231 817 0000	00	441 231 615		6.3	10.8	250	225	25	3.2	B9A	P
	6BN6	142 374 800 0000	00	142 354 600		6.3	1	60	60	0.5	1.0	B7G	P
	6BN7	851 231 408 0000	00	741 231 406		6.3	15	250		24	5.5	B9A	TT
	6BN7	851 231 408 0000	00	741 231 406		6.3	1	125		5	2	B9A	TT
	6BN8	911 23X 841 0000	00	811 239 641		6.3	3	250		1.6	2.5	B9A	DDT
	6BN11	214 780 517 0830	00	214 560 415	A	6.3	0.8	150	125	11	14	A12	PP
	6BP16	280 173 041 0000	00	260 153 041		6.3		150	150	50	26	B9A	P
	6BQ5	041 230 807 0000	00	*41 23* 6*5		6.3	7.3	250	250	48	11.3	B9A	P
	6BQ6	020 740 310 0000	80	020 540 310	A1	6.3	22.5	250	150	57	5.9	AO8	P

SPEC.	VALVE TYPE NUMBER	PIN CONNECTIONS				CHARACTERISTICS						BASE	VALVE CLASS
		VCM163 Tester Only		CT160, VT160, VCM Mk 1,2,3,4		Vh	Vg1	Va	Vg2	la	gm mA/V		
		SELECTOR SWITCH	TOP CAP	SELECTOR SWITCH	TOP CAP	V	V	V	V	mA	†Ra MΩ		
	6BQ7	851 238 410 0000	00	741 236 410		6.3	2	150		9	6	B9A	TT
	6BR5	410 230 807 0000	00	41* 23* 6*5		6.3	14	200	200	0.4	†0.5	B9A	TT
	6BR7	041 230 871 0000	00	041 230 651		6.3	3	250	100	2	1.2	B9A	P
	6BR8	481 238 715 0000	00	461 237 514		6.3	1	150		18	8.5	B9A	TP
	6BR8	481 238 715 0000	00	461 237 514		6.3	0.8	250	100	10	5.2	B9A	TP
	6BR8A	481 230 000 0000	00	461 230 000		6.3	1	125		3.5	7.5	B9A	TP
	6BR8A	000 238 715 0000	00	000 236 514		6.3	1	125	110	9.5	5.0	B9A	TP
	6BS3	090 230 901 0000	00	*8* 23* 8*1		6.3				180		B9D	R
	6BS3A	080 230 801 0000	00	060 230 601		6.3		12			140		R
	6BS4	842 314 800 0000	00	642 314 600		6.3	4	100		16	8	B7G	T
	6BS5	741 238 001 0000	00	541 236 **1		6.3	7.5	250	250	50	7	B9A	P
	6BS7	001 230 871 0000	40	001 230 651	G1	6.3	3	250	100	2	1.2	B9A	P
	6BS8	841 238 510 0000	00	641 237 410		6.3	2.2	150		10	7.2	B9A	TT
	6BT4	290 00X 130 0000	00	280 009 130		6.3				30		B8A	RR
	6BT6	412 39X 800 0000	00	412 389 600		6.3	3	250		1	1.2	B7G	DDT
	6BT8	9X1 238 741 0000	00	891 236 541		6.3	2.2	200	150	9.5	6.2	B9A	DDP
	6BU6	412 39X 800 0000	00	412 389 600		6.3	9	150		9.5	1.9	B7G	DDT
	6BU8	178 231 401 0000	00	157 231 461		6.3		100	60	2.2	1.5	B9A	PP
	6BU8	170 231 581 0000	00	157 231 461		6.3		100	60	2.2	1.5	B9A	PP
	6BV7	987 23X 141 0000	00	865 239 141		6.3	5	250	250	38	10	B9A	DDP
	6BV8	148 23X 119 0000	00	146 239 118		6.3	3.7	200		11	5.6	B9A	DDT
	6BW4	900 230 X01 0000	00	800 230 901		6.3				30		B9A	RR
	6BW6	041 230 871 0000	00	*41 230 651		6.3	13	300	225	34	3.7	B9A	P
	6BW7	141 230 871 0000	00	141 230 651		6.3	2.4	250	250	9.7	8.2	B9A	P
	6BW8	X19 234 178 0000	00	918 234 156		6.3	1.1	250	100	10	5.2	B9A	DDP
	6BW11	214 780 087 1530	00	-		6.3	0.8	150	125	11	14	A12	PP
	6BX4	902 30X 100 0000	00	802 309 100		6.3				30		B7G	RR
	6BX6	141 230 871 0000	00	141 230 651		6.3	3	200	200	8	7.2	B9A	P
	6BX7	581 481 230 0000	00	471 461 230		6.3	16.4	250		42	7.6	AO8	TT
	6BX8	841 238 510 0000	00	641 237 410		6.3	5	150		11	7.5	B9A	TT
	6BY5	120 X90 310 0000	00	120 980 310		6.3				60		AO8	RR
	6BY6	412 387 400 0000	00	412 365 400		6.3	2.5	250	100	6.5	2.4	B7G	H
	6BY7	141 230 871 0000	00	141 230 651		6.3	2	250	100	10	6	B9A	P
	6BY8	411 239 871 0000	00	411 238 651		6.3	1.1	100	100	5	3.9	B9A	DP
	6BZ6	412 387 100 0000	00	412 365 100		6.3	1	125	125	14	8	B7G	P
	6BZ7	851 238 410 0000	00	741 236 410		6.3	2.2	150		10	6.8	B9A	TT
	6BZ8	841 238 510 0000	00	641 237 410		6.3	1	150		10	8	B9A	TT
	6C2C	028 458 300 0000	00	026 447 300		6.3	8	250		9	2.6	AO8	TT
	6C3M	028 040 300 0000	00	026 040 300		2	2.5	150		1.5	1.3	AO8	T
	6C4	802 384 100 0000	00	602 364 100		6.3	8.5	250		10.5	2.2	B7G	T
	6C4A	028 040 300 0000	00	026 040 300		6.3		250		60	5.2	AO8	T
	6C5	028 040 310 0000	00	026 040 310		6.3	8	250		8	2	AO8	T
	6C6	287 113 000 0000	40	265 113 000	G1	6.3	3	250	100	2	1.2	UX6	P
	6C7	280 9X1 300 0000	40	260 891 300	G1	6.3	9	250		4.5	1.2	Sm7	DDT
	6C8	028 148 310 0000	50	026 147 310	G1	6.3	4.5	250		3.2	1.6	AO8	TT
	6C9	208 405 130 0000	00	276 454 130		6.3	2.5	100		5	3	B8A	TH
	6C9	280 575 130 0000	00	276 454 130		6.3	2.5	150	100	8	2.5	B8A	TH
	6C10	280 405 130 0000	00	276 454 130		6.3	2	100		5	2.2	B8A	TH
	6C10	208 575 130 0000	00	276 454 130		6.3	2	250	100	8	2.4	B8A	TH
	6C10	281 181 504 8630	00	-		6.3	2	250		1.2	1.6	A12	TTT
	6C12	751 238 084 0000	00	541 237 164		6.3	3	100		3	2	B9A	TH
	6C12	751 238 084 0000	00	541 237 164		6.3	2	250	100	6.5	2.4	B9A	TH

SPEC.	VALVE TYPE NUMBER	PIN CONNECTIONS				CHARACTERISTICS						BASE	VALVE CLASS
		VCM163 Tester Only		CT160, VT160, VCM Mk 1,2,3,4		Vh	Vg1	Va	Vg2	la	gm mA/V		
		SELECTOR SWITCH	TOP CAP	SELECTOR SWITCH	TOP CAP	V	V	V	V	mA	†Ra MΩ		
6C16	857 238 114 0000	00		645 237 114		6.3	2	100		14	5	B9A	TP
6C16	857 238 114 0000	00		645 237 114		6.3	2	200	175	10	6.2	B9A	TP
6C18	878 231 514 0000	00		657 231 414		6.3	3	100		14	5.5	B9A	TP
6C18	878 231 514 0000	00		657 231 414		6.3	1.5	125	125	10	11	B9A	TP
6C31	020 048 310 0000	40		027 546 310	G1	6.3	4	100		7	3.4	AO8	TH
6C31	028 750 310 0000	50		027 546 310	G1	6.3	3	250	100	5	2.8	AO8	TH
6C31	412 344 800 0000	00		412 344 600		6.3	15	150			12	B7G	T
6C93	200 800 100 803	00		-		6.3		20		600		A12	R
6CA4	901 230 X00 0000	00		9*1 23* 8**		6.3				60		B9A	RR
6CA5	142 347 800 0000	00		142 345 600		6.3	4.5	150	125	36	9.2	B7G	P
6CA7	128 740 310 0000	00		126 540 310		6.3	14.5	250	250	57	8.5	AO8	P
6CB5	721 441 370 0000	80		521 441 350	A	6.3	30	175	175	90	8.8	AO8	P
6CB5A	721 441 370 0000	80		521 441 350	A	6.3	0	75	150	460	8.8	AO8	P
6CB5A	721 441 370 0000	80		521 441 350	A	6.3	30	175	125	90	8.8	AO8	P
6CB6	412 387 100 0000	00		412 365 100		6.3	1	150	125	13	8	B7G	P
6CB6A	-	-		412 365 100		6.3	2	200	150	9.5	6.2	B7G	P
6CC10	481 581 230 0000	00		461 471 230		6.3	9	250		6.5	2.2	B8A	TT
6CC31	882 354 100 0000	00		672 344 100		6.3		200		6	3	B7G	TT
6CC40	841 238 510 0000	00		641 237 410		6.3	8.5	250		10.5	2.2	B9A	TT
6CC41	851 238 410 0000	00		741 236 410		6.3	1.5	250		2.3	2	B9A	TT
6CC42	214 808 513 0000	00		214 607 413		6.3	2	150		8	5.2	B9A	TT
6CC43	841 238 510 0000	00		641 237 410		6.3	2.3	250		10	5.9	B9A	TT
6CD6	021 040 370 0000	80		021 040 350	A1	6.3	30	200	175	75	7.7	AO8	P
6CK6G	-	-		021 040 350		6.3	30	200	150	64	6.7	AO8	P
6CD6GA	021 040 370 0000	80		021 040 350	A	6.3	30	175	175	75	7.7	B8G	P
6CD7	028 748 310 0000	00		026 546 310		6.3	4.2	250	250		†1.0	AO8	TI
6CD7	028 748 310 0000	00		026 546 310		6.3	12.5	250	250	1	†1.0	AO8	TI
6CE3	200 900 100 9030	00		-		6.3				180		A12	R
6CE5	412 387 100 0000	00		412 365 100		6.3	1	200	125	11	7.6	B7G	P
6CF5	402 387 100 0000	00		402 365 100		6.3		150	125	11	7.6	B7G	P
6CF6	412 387 100 0000	00		412 365 100		6.3	1	200	125	12	7.8	B7G	P
6CF8	701 238 014 0000	00		501 236 014		6.3	2	250	150	3	1.85	B9A	P
6CG6	412 387 100 0000	00		412 365 100		6.3	8	250	150	9	2	B7G	P
6CG7	841 238 510 0000	00		641 237 410		6.3	8	250		9	2.6	B9A	TT
6CG8	481 238 715 0000	00		461 237 514		6.3		100		8.5	5.8	B9A	TP
6CG8	481 238 715 0000	00		461 237 514		6.3	2	250	150	7.7	4.6	B9A	TP
6CH3	090 230 901 0000	00		080 230 801		6.3				180		B9A	R
6CH6	041 230 871 0000	00		041 230 651		6.3	4.5	250	250	40	11	B9A	P
6CH7	851 238 410 0000	00		741 236 410		6.3	2.2	150		10	6.8	B9A	TT
6CH8	187 321 548 0000	00		175 321 446		6.3	2	200		13	3.3	B9A	TP
6CH8	187 321 548 0000	00		175 321 446		6.3	2.2	200	150	9.5	6.3	B9A	TP
6CH40	751 238 584 0000	00		541 237 464		6.3	2	100		4.5		B9A	TH
6CH40	751 238 584 0000	00		541 237 464		6.3		250	100	10	3.2	B9A	TH
6CJ3	080 230 801 0000	00		060 230 601		6.3		16		350			R
6CJ5	280 074 130 0000	00		260 054 130		6.3	2.5	250	100	6	2.2	B8A	P
6CJ6	041 230 071 0000	80		041 230 051	A1	6.3		200	200	45	6.2	B9A	P
6CK3	080 230 801 0000	00		060 230 601		6.3		16		350			R
6CK4	424 080 310 0000	00		424 060 310		6.3	28	250		40	5.5	AO8	T
6CK5	281 074 130 0000	00		261 054 130		6.3	7	250	250	36	10	B8A	P
6CK6	741 231 800 0000	00		541 231 600		6.3	5.5	250	250	36	10	B9A	P
6CL3	080 230 801 1000	00		060 230 601		6.3		16		350		B9A	R
6CL5	721 441 370 0000	80		521 441 350	A1	6.3	40	150	150	80	6.3	AO8	P

SPEC.	VALVE TYPE NUMBER	PIN CONNECTIONS				CHARACTERISTICS						BASE	VALVE CLASS
		VCM163 Tester Only		CT160, VT160, VCM Mk 1,2,3,4		Vh	Vg1	Va	Vg2	la	gm mA/V		
		SELECTOR SWITCH	TOP CAP	SELECTOR SWITCH	TOP CAP	V	V	V	V	mA	†Ra MΩ		
	6CL6	147 238 174 0000	00	145 236 154		6.3	3	250	150	30	11	B9A	P
	6CL8	481 238 715 0000	00	461 237 514		6.3	0.8	150		150	8	B9A	TP
	6CL8	481 238 715 0000	00	461 237 514		6.3	1.0	150	125	12	5.8	B9A	TP
	6CM4	841 234 148 0000	00	641 234 146		6.3		200		12	14	B9A	T
	6CM5	020 740 310 0000	00	020 540 310		6.3	7	250	250	72	14	AO8	P
	6CM6	704 234 108 0000	00	504 234 106		6.3	12.5	250	250	45	4.1	B9A	P
	6CM7	801 238 451 0000	00	701 236 441		6.3	7	200		5	2	B9A	TT
	6CM7	801 238 451 0000	00	701 236 441		6.3	8	250		20	4.4	B9A	TT
	6CM8	851 238 714 0000	00	641 237 514		6.3	2	250		1.8	2	B9A	TP
	6CM8	851 238 714 0000	00	641 237 514		6.3		200	150	9.5	6.2	B9A	TP
	6CN5	028 740 310 0000	00	026 540 310		6.3	18	350	250	66	5.2	AO8	P
	6CN6	120 740 310 0000	00	120 540 310		6.3	7	250	250	100	14.3	AO8	P
	6CN7	X91 331 482 0000	00	981 331 462		3	3	250		1	1.2	B7G	DDT
	6CQ4	001 090 230 0000	00	**1 080 230		6.3				180		AO8	R
	6CQ6	412 381 700 0000	00	412 361 500		6.3	2.5	250	200	8	2.5	B7G	P
	6CQ8	857 238 114 0000	00	645 237 114		6.3	0.8	150		15	8	B9A	TP
	6CR8	857 238 114 0000	00	645 237 114		6.3	1	150	125	12	5.8	B9A	TP
	6CR4	414 484 234 0000	00	414 464 234		6.3	1	150		16	6	B9A	T
	6CR5	174 231 741 0000	80	154 231 541	A1	6.3	22.5	250	150	65	6	B9A	P
	6CR6	192 387 400 0000	00	182 365 400		6.3	2	250	100	9.5	2	B7G	DT
	6CR8	851 238 714 0000	00	641 237 514		6.3	2	150		12	4	B9A	TP
	6CR8	851 238 714 0000	00	641 237 514		6.3		150	125	13	7.7	B9A	TP
	6CS5	714 234 108 0000	00	514 234 1*6		6.3	10	200	125	47	8	B9A	P
	6CS6	412 387 100 0000	00	412 365 100		6.3	1	100	30	1	1.1	B7G	H
	6CS7	805 238 411 0000	00	604 237 411		6.3	8.5	250		10.5	2.2	B9A	TT
	6CS7	805 238 411 0000	00	604 237 411		6.3	10.6	250		19	4.5	B9A	TT
	6CS8	841 238 714 0000	00	641 237 514		6.3	2	150		12	4	B9A	TP
	6CS8	841 238 714 0000	00	641 237 514		6.3	0.9	150	125	13	7.7	B9A	TP
	6CT3	080 238 001 0000	00	060 236 001		6.3		16		350		B9A	R
	6CT7	289 174 130 0000	00	268 154 130		6.3	2	250	100	5	1.8	B8A	DP
	6CU5	142 347 800 0000	00	142 345 600		6.3	8	125	100	50	7.5	B8G	P
	6CU6	020 740 310 0000	80	020 540 310	A1	6.3	22.5	250	150	57	5.5	AO8	P
	6CU7	288 475 130 0000	00	276 454 130		6.3	2	100		5	2	B8A	TH
	6CU7	280 575 130 0000	00	276 454 130		6.3	2	250	100	8	2	B8A	TH
	6CU8	187 231 548 0000	00	175 231 446		6.3	6	200		13	3.3	B9A	TP
	6CU8	187 231 548 0000	00	175 231 446		6.3	2.2	200	150	9.5	6.2	B9A	TP
	6CV7	284 09X 130 0000	00	264 089 130		6.3	3	250		1	1.3	B8A	DDT
	6CW4	080 400 010 2030	00	-		6.3	1	100		7.6	9.8	NV5	T
	6CW5	041 230 807 0000	00	*41 23* 6*5		6.3	12.5	200	175	70	10	B9A	P
	6CW7	148 235 118 0000	00	147 234 116		6.3	1.5	90		12	6	B9A	TT
	6CX7	841 238 511 0000	00	641 237 411		6.3	2	150		9	6.4	B9A	TT
	6CX8	148 231 578 0000	00	146 231 457		6.3	1.5	150		9	4.6	B9A	TP
	6CX8	148 231 578 0000	00	146 231 457		6.3	2	200	125	24	10	B9A	TP
	6CY5	412 387 100 0000	00	412 365 100		6.3	1	150	75	10	8	B7G	P
	6CY7	805 238 411 0000	00	714 236 411		6.3	3	250		1.2	1.3	B9A	TT
	6CY7	805 238 411 0000	00	714 236 411		6.3	18.5	150		30	5.4	B9A	TT
	6CZ5	704 234 108 0000	00	504 234 1*6		6.3	14	250	250	46	4.8	B9A	P
	6D1	213 000 000 0000	90	123 000 000	D1	6.3						B3G	D
	6D2	1X2 310 900 0000	00	192 310 800		6.3						B7G	RR
	6D3	912 390 000 0000	00	812 380 000		6.3						B7G	R
	6D4	402 310 000 0000	00	402 310 000		6.3	110	18		100		B7G	T
	6D5	028 040 310 0000	00	026 040 310		6.3	40	300		31	2.1	AO8	T

SPEC.	VALVE TYPE NUMBER	PIN CONNECTIONS				CHARACTERISTICS						BASE	VALVE CLASS
		VCM163 Tester Only		CT160, VT160, VCM Mk 1,2,3,4		Vh	Vg1	Va	Vg2	la	gm mA/V		
		SELECTOR SWITCH	TOP CAP	SELECTOR SWITCH	TOP CAP	V	V	V	V	mA	†Ra MΩ		
6D6	287 113 000 0000	40		265 113 000	G1	6.3	3	250	100	2	1.2	Sm7	P
6D7	287 101 300 0000	00		265 101 300		6.3	3	250	100	2	12.2	AO8	P
6D8	029 748 310 0000	5		027 546 310	G1	6.3		150		4.2		AO8	H
6D8	029 748 310 0000	5		027 546 310	G1	6.3	3	250	100	3.5		AO8	H
6D10	281 181 506 8430	00		-		6.3	1.0	125		4.2	4.2	A12	TTT
6DA4	001 090 230 0000	00		**1 080 230		6.3				120		AO8	R
6DA6	041 230 871 0000	00		041 230 651		6.3	2	250	100	9	3.6	B9A	P
6DA7	805 238 411 0000	00		604 237 411		6.3	8	250		9	2.6	B9A	TT
6DA7	805 238 411 0000	00		604 237 411		6.3	17.5	150		40	5.7	B9A	TT
6DB5	714 234 108 0000	00		514 234 1*6		6.3	9.6	200	125	46	8	B9A	P
6DB6	412 387 100 0000	00		412 365 100		6.3	1	150	150	5.8	2	B7G	P
6DC6	412 387 100 0000	00		412 365 100		6.3	2.2	200	150	9.5	5.5	B7G	P
6DC8	741 238 8X1 0000	00		541 236 891		6.3	2	250	100	9	3.8	B9A	DDP
6DDHV1	157 238 984 0000	00		145 237 864		6.3	2	250		90	1.6	B9A	DTP
6DDHV1	157 238 984 0000	00		145 237 864		6.3	1	250	100	9	3.5	B9A	DTP
6DE4	001 090 230 0000	00		001 080 230		6.3				120		AO8	R
6DE6	412 387 100 0000	00		412 365 100		6.3	1.1	150	125	16	8	B7G	P
6DE7	855 238 411 0000	00		744 236 411		6.3	17.5	150		32	6.5	B9A	TT
6DE7	855 238 411 0000	00		744 236 411		6.3	11	250		5.5	2	B9A	TT
6DG6	028 740 310 0000	00		026 540 310		6.3	7.5	200	125	47	8	AO8	P
6DG7	041 230 871 0000	00		041 230 651		6.3	20	250	100	11	4.4	B9A	P
6DJ8	841 238 511 0000	00		641 237 411		6.3	1.3	90		15	12.5	B9A	TT
6DK6	412 387 100 0000	00		412 365 100		6.3	0.9	150	125	12	9.8	B7G	P
6DL4	414 234 484 0000	00		414 234 464		6.3		150		12.5	14	B9A	T
6DL5	412 387 400 0000	00		412 365 400		6.3	7.3	250	225	26	5.5	B7G	P
6DM4	001 090 230 0000	00		001 080 230		6.3				180		AO8	R
6DN3	080 230 801 0000	00		060 230 601		6.3		14		350		B9A	R
6DN6	021 040 370 0000	80		021 040 350	A1	6.3	18	200	125	70	9	AO8	P
6DN7	481 581 230 0000	00		461 471 230		6.3	9.5	250		34	7.4	AO8	TT
6DQ4	001 090 230 0000	00		-		6.3				120		AO8	R
6DQ5	421 741 370 0000	80		421 541 350	A1	6.3	25	175	125	110	10.5	AO8	P
6DQ6	020 740 310 0000	80		020 540 310	A1	6.3	22.5	250	150	75	6.6	AO8	P
6DQ8	481 238 141 0000	00		461 237 141		6.3	1.7	200		3	11	B9A	TP
6DQ8	481 238 141 0000	00		461 237 141		6.3	2.1	200	175	18	6.5	B9A	TP
6DR4	123 000 000 0000	90		123 000 000	D1	6.3						B3G	D
6DR6	041 230 071 0000	00		*41 23* *51		6.3	23	200	175	45	6.6	B9A	P
6DR7	855 238 411 0000	00		644 237 411		6.3	17.5	150		35	6.5	B9A	TT
6DR7	855 238 411 0000	00		644 237 411		6.3	3	250		1.4	1.6	B9A	TT
6DR8	741 238 9X1 0000	00		541 236 891		6.3		12	12	45		B9A	DDP
6DS4	080 400 010 2030	00		-		6.3	0.9	100		6.5	9	NU5	T
6DS5	412 387 100 0000	00		412 365 100		6.3	8.5	250	200	29	5.8	B7G	P
6DS8	751 238 184 0000	00		541 237 164		6.3		12		0.7	1.4	B9A	TP
6DS8	751 238 184 0000	00		541 237 164		6.3		12	12	0.4	0.7	B9A	TP
6DT5	704 230 108 0000	00		504 230 1*6		6.3	16.5	250	250	38	6.5	B9A	P
6DT6	412 387 100 0000	00		412 365 100		6.3	2.2	150	100	11	0.8	B7G	P
6DT6A	412 387 100 0000	00		412 365 100		6.3	5.2	150	100	1.55	1.35	G7-1	P
6DT8	851 238 410 0000	00		741 236 410		6.3	2.5	250		10	5.5	B9A	TT
6DV4	880 404 100 2030	00		-		6.3	1	75		10.5	11.5	NV7	T
6DW4	090 230 901 0000	00		*8* 23* 8*1		6.3				180		B9D	R
6DW4B	080 230 801 0000	00		060 230 601		6.3		25		350			R
6DW5	704 234 108 0000	00		504 234 106		6.3	22.5	200	150	55	5.5	B9A	P

SPEC.	VALVE TYPE NUMBER	PIN CONNECTIONS				CHARACTERISTICS						BASE	VALVE CLASS
		VCM163 Tester Only		CT160, VT160, VCM Mk 1,2,3,4		Vh	Vg1	Va	Vg2	la	gm mA/V		
		SELECTOR SWITCH	TOP CAP	SELECTOR SWITCH	TOP CAP	V	V	V	V	mA	†Ra MΩ		
	6DX8	481 238 157 0000	00	461 237 145		6.3	1.7	200		3	4	B9A	TP
	6DX8	481 238 157 0000	00	461 237 145		6.3	2	170	170	18	10.4	B9A	TP
	6DY7	041 230 807 0000	00	041 230 605		6.3	12.5	250	150	50	6	B9A	P
	6DZ4	842 314 800 0000	00	642 314 600		6.3	0.3	75		15	6.7	B7G	T
	6DZ7	428 718 310 0000	00	426 517 310		6.3	7.3	250	250	48	11.3	AO8	PP
	6DZ8	415 238 718 0000	00	414 237 516		6.3		150		0.8	1.4	B9A	TP
	6DZ8	415 238 718 0000	00	414 237 516		6.3		150	125	45	7.5	B9A	TP
	6E4	751 238 584 0000	00	541 237 464		6.3	2.6	200		5.4		B9A	TH
	6E4	751 238 584 0000	00	541 237 464		6.3		200	100	3.7		B9A	TH
	6E5	284 713 000 0000	00	264 513 000		6.3	7.5	250	250	0.2	†1.0	UX6	TI
	6E6	285 148 300 0000	00	274 146 300		6.3	27.5	250		18	1.7	UX7	TT
	6E7	287 101 300 0000	40	265 101 300	G1	6.3	2	250	100	8.2	1.6	Sm7	P
	6E8	020 748 310 0000	50	027 546 310	G1	6.3	4.8	150		3.3	2.8	AO8	TH
	6E8	028 740 310 0000	50	027 546 310	G1	6.3	2.3	250	100	2.3	3.5	AO8	TH
	6E102	802 310 470 0000	00	602 301 450		6.3	7	250	250	72	15	F8	P
	6EA5	412 387 100 0000	00	412 365 100		6.3	1	250	150	10	8	B7G	P
	6EA6	481 581 230 0000	00	461 471 230		6.3	25	200		48	6.5	AO8	TT
	6EA7	481 581 230 0000	00	461 471 230		6.3	25	200		48	6.5	AO8	TT
	6EA8	857 238 114 0000	00	645 237 114		6.3	1	150		18	8.5	B9A	TP
	6EA8	857 238 114 0000	00	645 237 114		6.3	1	125	125	12	6.4	B9A	TP
	6EB5	192 310 X00 0000	00	182 310 900		6.3				7		B9G	DD
	6EB8	148 231 578 0000	00	146 231 457		6.3	2	250		2	2.7	B9A	TP
	6EB8	148 231 578 0000	00	146 231 457		6.3	2	200	125	25	12	B9A	TP
	6EF6	028 740 310 0000	00	026 540 310		6.3	18	250	250	50	5	AO8	P
	6EH5	142 347 800 0000	00	142 345 600		6.3	3.2	100	125	42	14.6	B7G	P
	6EH6	412 387 100 0000	00	412 365 100		6.3	1	250	150	7.4	4.6	B7G	P
	6EH7	141 230 871 0000	00	141 230 651		6.3	2	200	90	12	12.5	B9A	P
	6EH8	148 231 578 0000	00	146 231 457		6.3	1	150		13	7.5	B9A	TP
	6EH8	148 231 578 0000	00	146 231 457		6.3	1	150	125	12	6	B9A	TP
	6EJ7	141 230 871 0000	00	141 230 651		6.3	2.5	200	200	10	15	B9A	P
	6EL7	141 230 871 0000	00	141 230 651		6.3	1.8	200	175	10	8.8	B9A	P
	6EM5	704 234 108 0000	00	504 234 106		6.3	18	250	250	35	5.1	B9A	P
	6EM7	581 481 230 0000	00	471 461 230		6.3	3	250		1.4	1.6	AO8	TT
	6EM7	581 481 230 0000	00	471 461 230		6.3	20	150		50	7.2	AO8	TT
	6EQ7	141 237 890 0000	00	141 235 680		6.3		100	100	9	3.9	B9A	DP
	6ER5	142 381 010 0000	00	142 361 *10		6.3	1.2	200		10	10.5	B7G	T
	6ES5	142 380 100 0000	00	142 360 100		6.3	1	200		15	9.5	B7G	P
	6ES6	412 387 100 0000	00	412 365 100		6.3	0.7	12	12			B9A	P
	6ES8	841 238 510 0000	00	641 237 410		6.3	1.2	90		15	12.5	B9A	TT
	6ET6	412 387 100 0000	00	412 365 100		6.3	1	12	12	4.8	3	B7G	P
	6ET7	19X 231 478 0000	00	189 231 456		6.3		200	150	25	11.5	B9A	DDP
	6EU7	230 148 851 0000	00	230 146 741		6.3	2	250		1.2	1.6	B9A	TT
	6EU8	848 231 517 0000	00	746 231 415		6.3	1	150		18	8.5	B9A	TP
	6EU8	848 231 517 0000	00	746 231 415		6.3	1	150	100	12	6.4	B9A	TP
	6EV5	412 387 100 0000	00	412 365 100		6.3		200	80	11.5	8.8	B7G	P
	6EV6	841 238 510 0000	00	641 237 410		6.3	2	250		9.2	5.2	B9A	TT
	6EV7	841 238 510 0000	00	641 237 410		6.3	2.0	250		9.2	5.2	B9A	TT
	6EW6	412 387 100 0000	00	412 365 100		6.3	0.8	150	125	11	14	B7G	P
	6EW7	855 238 411 0000	00	744 236 411		6.3	17.5	150		45	7.5	B9A	TT
	6EW7	855 238 411 0000	00	744 236 411		6.3	11	250		5.5	2	B9A	TT
	6EX4	902 30X 100 0000	00	802 309 100		6.3				30		B9A	RR
	6EX6	021 040 370 0000	80	021 040 350	A1	6.3		200	150	67	7.7	AO8	P



SPEC.	VALVE TYPE NUMBER	PIN CONNECTIONS				CHARACTERISTICS						BASE	VALVE CLASS
		VCM163 Tester Only		CT160, VT160, VCM Mk 1,2,3,4		Vh	Vg1	Va	Vg2	Ia	gm mA/V		
		SELECTOR SWITCH	TOP CAP	SELECTOR SWITCH	TOP CAP	V	V	V	V	mA	†Ra MΩ		
	6EY6	028 740 310 0000	00	026 540 310		6.3	17.5	250	250	44	4.4	AO8	P
	6EZ5	028 740 310 0000	00	026 540 310		6.3	20	250	250	43	4.1	B8A	P
	6EZ8	168 238 584 0000	00	14† 237 464		6.3	1	150		4.2	4.2	B9A	TTT
	6F1	281 714 130 0000	00	261 514 130		6.3	1.8	200	200	10	9	B8A	P
	6F5	020 800 310 0000	40	020 600 310	G1	6.3	2	250		0.9	1.5	AO8	T
	6F6	028 740 310 0000	00	026 540 310		6.3	16.5	250	250	34	2.5	AO8	P
	6F7	287 841 300 0000	50	275 641 300	G1	6.3	3	100		3.5	0.5	Sm7	TP
	6F7	287 841 300 0000	50	275 641 300	G1	6.3	3	100	100	6.3	1	Sm7	TP
	6F7B	297 841 300 0000	50	275 641 300	G1	6.3	3	100		3.5	0.5	UX7	TP
	6F7B	297 841 300 0000	50	275 641 300	G1	6.3	3	100	100	6.3	1	UX7	TP
	6F7M	023 878 410 0000	50	275 641 300	G1	6.3	3	100		3.5	0.5	UX7	TP
	6F7M	023 878 410 0000	50	275 641 300	G1	6.3	3	100	100	6.3	1	UX7	TP
	6F8	028 158 310 0000	40	027 146 310	G1	6.3	8	250		9	2.6	AO8	TT
	6F10	021 417 380 0000	00	021 415 360		6.3	2	300	150	10	9	AO8	P
	6F11	280 174 130 0000	00	260 154 130		6.3	1.8	250	100	4.4	2.2	B8A	P
ξ	6F12	412 381 700 0000	00	412 361 500		6.3	2	250	250	10	7.5	B7G	P
ξ	6F12	412 381 700 0000	00	412 361 500		6.3	1.5	200	150	4	6.4	B7G	P
	6F13	280 174 130 0000	00	260 154 130		6.3	1.8	200	200	10	9	B8A	P
	6F14	280 174 130 0000	00	260 154 130		6.3	1.25	150	150	28	10.6	B8A	P
	6F15	281 174 130 0000	00	261 154 130		6.3	2.5	250	100	7	2.3	B8A	P
	6F16	281 174 130 0000	00	261 154 130		6.3	2.5	250	100	6	2.2	B8A	P
	6F17	412 381 700 0000	00	412 361 500		6.3	5	100	100	12.5	4.0	B7G	P
	6F18	141 230 871 0000	00	141 230 651		6.3	1.3	200	100	12	4.5	B9A	P
	6F19	141 230 871 0000	00	141 230 651		6.3	2	250	100	10	6	B9A	P
	6F20	141 230 871 0000	00	141 230 651		6.3	2	200	175	10	6	B9A	P
	6F21	412 381 700 0000	00	412 361 500		6.3	2.5	250	200	7.8	2.5	B7G	P
	6F22	701 238 014 0000	00	501 236 014		6.3	2	250	150	3	1.8	B9A	P
	6F23	141 231 871 0000	00	141 230 650		6.3	1.9	150	150	10	9.2	B9A	P
	6F24	141 230 871 0000	00	141 230 651		6.3	1.9	170	170	10	15	B9A	P
	6F25	141 230 871 0000	00	141 230 651		6.3	1.5	200	100	11.5	12.5	B9A	P
	6F26	141 230 871 0000	00	141 230 651		6.3	2	250	100	10	6	B9A	P
	6F28	141 234 870 0000	00	*41 234 650		6.3	2.9	200	200	10	12.5	B9A	P
	6F29	141 230 871 0000	00	141 230 651		6.3	2	200	90	12	12.5	B9A	P
	6F30	141 230 871 0000	00	141 239 651		6.3	2.5	200	200	10	15.4	B9A	P
	6F31	412 387 100 0000	00	412 365 100		6.3	1	250	100	11	4.2	B7G	P
	6F32	412 387 100 0000	00	412 365 100		6.3		200	125	8	4.6	B7G	P
	6F32	218 710 030 0000	40	216 510 030	G1	6.3	4.5	200	200	5.1	3	M08	P
	6F32V	412 387 000 0000	00	412 365 000		6.3	3	150	150	7	4.3	B7G	P
	6F33	412 381 700 0000	00	412 361 500		6.3	2	125	125	5.2	3.5	B7G	P
	6F35	412 387 100 0000	00	412 365 100		6.3		40	30	2.7	2.7	B7G	P
	6F36	412 387 100 0000	00	412 365 100		6.3		300	150	10	9	B7G	P
	6F40	111 231 874 0000	00	111 231 654		6.3	2	250	150	3	2	B9A	P
	6F41	141 230 871 0000	00	141 230 651		6.3	2.0	150	150	10	7.4	B9A	P
	6F60	041 230 887 0000	00	041 230 665		6.3	23	250	200	55	5	B9A	P
	6F80	741 231 800 0000	00	541 231 600		6.3		200	200	36	10	B9A	P
	6FA7	941 238 741	-	841 236 541		6.3	0	100	100	2.2	1.9	B9A	DPP
	6FA7	941 238 741	-	841 236 541		6.3	0	100	100	3.8	3.2	B9A	DPP
	6FC7	148 235 018 0000	00	146 234 017		6.3	1.2	90		15	12	B9A	TT
	6FD6	412 387 100 0000	00	412 365 100		6.3		12	12		1.4	B7G	P
	6FD7	855 238 411 0000	00	644 237 411		6.3	17.5	150		45	7.5	B9A	TT
	6FD7	855 238 411 0000	00	644 237 411		6.3		250		6	1.6	B9A	TT

SPEC.	VALVE TYPE NUMBER	PIN CONNECTIONS				CHARACTERISTICS						BASE	VALVE CLASS
		VCM163 Tester Only		CT160, VT160, VCM Mk 1,2,3,4		Vh	Vg1	Va	Vg2	la	gm mA/V		
		SELECTOR SWITCH	TOP CAP	SELECTOR SWITCH	TOP CAP	V	V	V	V	mA	†Ra MΩ		
	6FD12	741 238 9X1 0000	00	541 236 891		6.3	2	250	100	9	3.8	B9A	DDP
	6FE5	028 740 310 0000	00	026 540 310		6.3	12.5	100	100	94	9.5	AO8	P
	6FG5	412 387 100 0000	00	412 365 100		6.3	0.2	250	250	9	9.5	B7G	P
	6FG6	401 237 805 0000	00	401 235 607		6.0	22	250	250	0.5	†0.5	B9A	TI
	6FG7	481 238 715 0000	00	461 237 514		6.3	1	125		13	7.5	B9A	TP
	6FG7	481 238 715 0000	00	461 237 514		6.3	1	125	125	11	6	B9A	TP
	6FH5	142 380 100 0000	00	142 365 100		6.3	1	150		11	9	B7G	T
	6FH6	020 740 310 0000	80	020 540 310	A1	6.3	22.5	250	150	75	6	AO8	P
	6FJ7	204 080 101 5830	00	204 060 101		6.3	8	250		8	2.5	A12	TT
	6FJ7	204 080 101 5830	00	204 060 101		6.3	9.5	250		41	7.7	A12	TT
	6FJ8	210 741 390 0000	80	210 541 380	A1	6.3	22.5	250	150	75	6.6	AO8	DP
	6FLD12	741 238 9X1 0000	00	541 236 891		19	2	250	100	9	3.8	B9A	DDP
	6FM7	205 080 151 4830	00	204 060 141		6.3	3	250		2	2.2	A12	TT
	6FM7	205 080 151 4830	00	204 060 141		6.3	25	175		40	6	A12	TT
	6FM8	191 23X 148 0000	00	181 239 146		6.3	3	250		1	1.2	B9A	DDT
	6FN5	721 441 370 0000	00	521 441 350		6.3	22.5	200	150	100	10	B8A	P
	6FQ5	142 380 100 0000	00	142 360 100		6.3	1.2	150		11	11	B7G	T
	6FQ7	841 238 510 0000	00	741 236 410		6.3	8	250		9	2.6	B9A	TT
	6FR7	855 238 411 0000	00	644 237 411		6.3	3	250		1.4	6.8	B9A	TT
	6FR7	855 238 411 0000	00	644 237 411		6.3	20	150		50	5.4	B9A	TT
	6FS5	412 387 100 0000	00	412 365 100		6.3	0.2	300	150	9	10	B7G	P
	6FV6	402 387 100 0000	00	402 365 100		6.3	1	150	75	10	8	B9A	P
	6FV8	481 238 715 0000	00	461 237 514		6.3	1	150		14	8	B9A	TP
	6FV8	481 238 715 0000	00	461 237 514		6.3	1	150	125	12	6.5	B9A	TP
	6FW5	421 080 370 0000	00	421 060 350		6.3	22.5	250	150	65	7.3	AO8	P
	6FW8	851 238 410 0000	00	741 236 410		6.3	1.2	100		15	13	B9A	TT
	6FX4	902 30X 100 0000	00	802 309 100		6.3				30		B7G	RR
	6FY5	142 380 100 0000	00	142 360 100		6.3	1	150		11	13	B9A	T
	6FY7	205 080 101 4830	00	205 080 101		6.3	3	250		1.4	1.6	A12	TT
	6FY7	205 080 101 4830	00	205 080 101		6.3	17.5	150		35	6.5	A12	TT
	6FY8	415 238 718 0000	00	414 237 516		6.3	1.5	125		2.5	2	B9A	TP
	6FY8	415 238 718 0000	00	414 237 516		6.3	13.5	125	125	50	7	B9A	TP
	6G5	284 713 000 0000	00	264 513 000		6.3	22	250	250	0.2	†1.0	UX6	TI
	6G6	028 740 310 0000	00	026 540 310		6.3	9	200	175	15	2.3	AO8	P
	6G7	028 X97 310 0000	40	026 985 310	G1	6.3	3	250	125	10	1.3	AO8	DDP
	6G8	028 X97 310 0000	40	026 985 310	G1	6.3	3	250	125	9	1.1	AO8	DDP
	6G11	215 108 741 7830	00	214 106 541		6.3	8	125	100	49	7.5	A12	PP
	6G11	215 108 741 7830	00	214 106 541		6.3	1.8	150	100	1.3	1.0	A12	PP
	6GA4	028 040 310 0000	00	026 040 310		6.3	18.5	250		50	7	AO8	T
	6GA7	277 410 810 0930	00	255 410 610		6.3				120		A12	RP
	6GA7	277 410 810 0930	00	255 410 610		6.3	22.5	250	150	75	6.6	A12	RP
	6GA8	841 238 510 0000	00	641 237 410		6.3		250		8		B9A	TT
	6GA8	428 040 310 0000	00	426 040 310		6.3	18.5	250		50	7	AO8	T
	6GB3	030 740 310 0000	80	020 540 310	A1	6.3	7.7	100	100	100	14	AO8	P
	6GB5	-	-	441 235 51*	A1	6.3	20	150	150	70	10	B9A	P
	6GB6	020 740 310 0000	80	020 540 310	A1	6.3	22.5	250	150	6.5	6	AO8	P
	6GB7	020 740 310 0000	80	020 540 310	A1	6.3	7.7	100	100	100	14	AO8	P
	6GB9	020 740 310 0000	80	020 540 310	A1	6.3	22.5	250	150	75	6.6	AO8	P
	6GC5	714 234 178 0000	00	514 234 156		6.3	7.5	100	100	50	8	B9D	P
	6GC6	021 740 370 0000	80	021 540 350	A1	6.3	22.5	250	150	75	6.6	AO8	P
	6GD7	481 238 715 0000	00	481 238 715		6.3	1	125		15	10	B9A	TP
	6GD7	481 238 715 0000	00	481 238 715		6.3	1	175	150	10	12	B9A	TP
	6GE5	274 100 800 1430	00	-		6.3	22.5	250	150	65	7.3	A12	P
	6GE7	028 47X 310 0000	00	026 457 310	A	6.3	5	250	250			AO8	-
	6GE8	714 238 153 0000	00	514 236 147		6.3	21	150		35	5	B9A	TP
	6GE8	714 238 153 0000	00	514 236 147		6.3	2	150	150	5.5	3.2	B9A	TP

SPEC.	VALVE TYPE NUMBER	PIN CONNECTIONS				CHARACTERISTICS						BASE	VALVE CLASS
		VCM163 Tester Only		CT160, VT160, VCM Mk 1,2,3,4		Vh	Vg1	Va	Vg2	Ia	gm mA/V		
		SELECTOR SWITCH	TOP CAP	SELECTOR SWITCH	TOP CAP	V	V	V	V	mA	†Ra MΩ		
6GF5	274 100 800 1430	00		254 100 600		6.3	26.5	250	150	34	4.7	A12	P
6GF7	151 238 084 0000	00		141 237 064		6.3	3	250		1.4	1.6	B9D	TT
6GF7	151 238 084 0000	00		141 237 064		6.3	20	150		50	7.2	B9D	TT
6GF7A	141 23X 095 0000	80		141 239 084	A	6.3	3	250		1.4		B9D	TT
6GF7A	141 23X 095 0000	80		141 239 084	A	6.3	20	150	50			B9D	TT
6GG6	902 300 1X0 0000	00		802 300 190		6.3				30		F8	RR
6GH8	857 238 114 0000	00		645 237 114		6.3	1	150		13.5	8.5	B9A	TP
6GH8	857 238 114 0000	00		645 237 114		6.3	1	150	125	12	7.5	B9A	TP
6GH8A	847 238 114 0000	00		645 237 114		6.3	1	125		13.5	8.5	B9A	TP
6GH8A	847 238 114 0000	00		645 237 114		6.3	1	125	125	12.0	7.5	B9A	TP
6GJ5	741 234 700 0000	80		541 234 5**	A1	6.3	22.5	250	150	70	7.1		-
6GJ5A	741 234 700 0000	80		541 234 500	A	6.3	22.5	250	150	70	7.1	B9A	P
6GJ7	151 238 784 0000	00		141 236 574		6.3	3	100		15	9	B9A	TP
6GJ7	151 238 784 0000	00		141 236 574		6.3	1.2	200	200	10	11	B9A	TP
6GJ8	857 238 114 0000	00		645 237 114		6.3	1	150		13.5	8.5	B9A	TP
6GJ8	857 238 114 0000	00		645 237 114		6.3	1	125	125	12	7.5	B9A	TP
6GK5	142 380 100 0000	00		142 360 100		6.3	1	150		11.5	15	B7G	T
6GK6	141 230 871 0000	00		141 230 651		6.3	7.3	250	250	48	11.3	B9A	P
6GK17	001 090 230 0000	00		001 080 230		6.3						AO8	R
6GL7	481 481 230 0000	00		471 461 230		6.3	3	250		2.0	2.2	B8B	TT
6GM5	700 234 108 0000	00		500 234 106		6.3	10	300	300	60	10.2	B9A	P
6GM6	412 387 100 0000	00		412 365 100		6.3	2	125	125	14	2.6	B7G	P
6GM8	-	-		641 237 410		6.3	0.3	12		2.4	4.6	B9A	TT
6GN6	412 387 900 0000	00		412 365 800		6.3	68	250	100	11	4.4	B7G	DP
6GN8	148 231 578 0000	00		146 231 457		6.3	2	250		2	2.7	B9A	TP
6GN8	148 231 578 0000	00		146 231 457		6.3	3	200	150	25	11.5	B9A	TP
6GQ7	1Y0 23X 191 0000	00		11* 239 181		6.3				5		B9A	DDD
6GS8	170 231 481 0000	00		156 231 471		6.3	0.5	100	75	2	1.2	B9A	PP
6GS8	178 231 501 0000	00		156 231 471		6.3	0.5	100	75	2	1.2	B9A	PP
6GT5	741 234 708 0000	00		541 234 5*6		6.3	42	250	150	70	7.1	B9D	P
6GT5A	741 234 708 0000	00		541 234 506		6.3	22.5	250	150	70	7.1	B9A	TP
6GU5	412 387 100 0000	00		412 365 100		6.3	0.4	150	150	9	15	B7G	P
6GU7	851 238 410 0000	00		641 237 410		6.3	10.5	250		11.5	3.1	B9A	TT
6GV5	207 140 704 1730	80		205 140 504		6.3	22.5	250	150	65	7.3	A12	P
6GV7	878 231 514 0000	00		657 231 414		6.3		100		14	5.5	B9A	TP
6GV7	878 231 514 0000	00		657 231 414		6.3	1.5	150	150	11	11	B9A	TP
6GV8	841 238 715 0000	00		641 237 514		6.3	0.6	100		5	6.5	B9A	TP
6GV8	841 238 715 0000	00		641 237 514		6.3	15	200	175	41	7.5	B9A	TP
6GW5	842 314 100 0000	00		642 314 100		6.3	1	150		13	15	B7G	T
6GW6	020 740 310 0000	80		020 540 310		6.3	22.5	250	150	70	7.1	AO8	P
6GW8	417 238 158 0000	00		415 237 146		6.3	1.7	250		1.2	1.6	B9A	TP
6GW8	417 238 158 0000	00		415 237 146		6.3	7	250	250	36	10	B9A	TP
6GX6	412 387 100 0000	00		412 365 100		6.3		150	100	3.7	3.7	G7G	P
6GX7	151 238 784 0000	00		141 237 564		6.3	1	125	125	8	11	B9A	TP
6GY5	207 140 704 1730	80		2*5 140 504		6.3	20	125	125	50	9.1	A12	P

SPEC.	VALVE TYPE NUMBER	PIN CONNECTIONS				CHARACTERISTICS						BASE	VALVE CLASS
		VCM163 Tester Only		CT160, VT160, VCM Mk 1,2,3,4		Vh	Vg1	Va	Vg2	la	gm mA/V		
		SELECTOR SWITCH	TOP CAP	SELECTOR SWITCH	TOP CAP	V	V	V	V	mA	†Ra MΩ		
6H1	412 380 700 0000	00		412 360 500		6.3	1.8	250	100		2.1	B7G	H
6H4	020 900 310 0000	00		020 800 310		6.3						AO8	D
6H5	284 713 000 0000	00		264 513 000		6.3	22	250	250	0.2	†1.0	UX6	TI
6H6	02X 190 310 0000	00		029 180 310		6.3						AO8	DD
6H7C	028 458 310 0000	00		026 447 310		6.3	5	250		3	1.6	AO8	TT
6H7G	128 458 310 0000	00		126 447 310		6.3		300		35	3.2	AO8	TT
6H8C	481 581 230 0000	00		461 471 230		6.3	8	250		9	3	AO8	TT
6H8G	028 X97 310 0000	40		026 985 310	G1	6.3	2	250	125	8.5	2.4	AO8	DDP
6H8MG	028 X97 310 0000	40		026 985 310	G1	6.3	2	250	125	6	1.8	AO8	DDP
6H9C	481 581 230 0000	00		461 471 230		6.3	2	250		2.2	1.6	AO8	TT
6H10C	084 581 230 0000	00		064 471 230		6.3	2	250		2	1.3	AO8	TT
6H13C	481 581 230 0000	00		461 471 230		6.3	30	90		80	5	AO8	TT
6H31	412 387 100 0000	00		412 365 100		6.3		250	100	3		B7G	H
6HA5	412 380 100 0000	00		412 360 100		6.3	1	150		11.5	14.5	B7G	T
6HB5	274 100 800 1430	00		254 100 600		6.3	20	125	125	50	9.1	A12	P
6HB6	141 230 871 0000	00		141 230 651		6.3	33	250	125	40	24	B9A	P
6HB7	151 238 784 0000	00		141 236 574		6.3	1	150		18	8.5	B9A	TP
6HB7	151 238 784 0000	00		141 236 574		6.3	1	125	125	12	6.4	B9A	TP
6HC8	415 238 718 0000	00		414 237 516		6.3	3	250		1.4	2	B9A	TP
6HC8	415 238 718 0000	00		414 237 516		6.3	18	250	250	38	5.1	B9A	TP
6HD5	207 140 804 1730	00		-		6.3	22	150	150	65	10	A12	P
6HE5	243 108 004 7130	00		-		6.3	20	250	250	43	4.1	A12	P
6HE7	290 180 014 0730	00		-		6.3				120		A12	RP
6HE7	290 180 014 0730	00		-		6.3	22	125	125	60	8.8	A12	RP
6HF5	207 147 074 1730	80		-		6.3	28	175	175	100	11	A12	P
6HF8	148 231 578 0000	00		146 231 457		6.3	2	200		4	4	B9A	TP
6HF8	148 231 578 0000	00		146 231 457		6.3		200	125	25	12.5	B9A	TP
6HG5	412 387 400 0000	00		412 365 400		6.3	12.5	250	250	45	4.1	B7G	P
6HG8	151 234 887 0000	00		141 234 675		6.3	3	100		14	6	B9A	TP
6HG8	151 234 887 0000	00		141 234 675		6.3	1.2	200	150	10	12	B9A	TP
6HJ8	147 238 191 0000	00		145 236 181		6.3	6	150	125	11.5	9.3	B9A	DP
6HK5	412 380 100 0000	00		412 360 100		6.3	1	150		12.5	15	B7G	T
6HK8	841 238 510 0000	00		641 237 410		6.3	1	90		8.5	8	B9A	TT
6HL8	857 238 114 0000	00		645 237 114		6.3	1	125		12.5	7	B9A	TP
6HL8	857 238 114 0000	00		645 237 114		6.3	1	125	125	12	10	B9A	TP
6HM5	412 380 100 0000	00		412 360 100		6.3	1.2	150		12.5	14.5	B7G	T
6HM6	141 230 871 0000	00		141 230 651		6.3	3.9	125	125	13	15	B9A	P
6HQ5	412 381 100 0000	00		412 361 100		6.3	1	150		11.5	15	B7G	T
6HR6	412 387 100 0000	00		412 365 100		6.3	1.2	200	100	13.2	8.5	B7G	P
6HS6	412 387 100 0000	00		412 365 100		6.3	0.8	150	75	8.8	9.5	B7G	P
6HS8	178 231 401 0000	00		157 231 461		6.3	0	100	75	2	0.4	B9A	PP
6HS8	170 231 581 0000	00		157 231 461		6.3	0	100	75	2	0.4	B9A	PP
6HU8	748 235 187 0000	00		546 234 175		6.3	9	250	250	24	6	B9A	PP
6HW8	187 234 181 0000	00		165 234 161		6.3	3.5	250	250	13	4	B9A	P
6HZ6	412 387 100 0000	00		412 387 100		6.3	1.1	150	100	3.2	3.4	B7G	P
6HZ8	148 231 578 0000	00		146 231 457		6.3	2	200		3.5	4	B9A	TP
6HZ8	148 231 578 0000	00		146 231 457		6.3		250	175	29	12.6	B9A	TP
6J4	412 344 800 0000	00		412 344 600		6.3	1.5	150		15	12	B7G	T

SPEC.	VALVE TYPE NUMBER	PIN CONNECTIONS				CHARACTERISTICS						BASE	VALVE CLASS
		VCM163 Tester Only		CT160, VT160, VCM Mk 1,2,3,4		Vh	Vg1	Va	Vg2	la	gm mA/V		
		SELECTOR SWITCH	TOP CAP	SELECTOR SWITCH	TOP CAP	V	V	V	V	mA	†Ra MΩ		
	6J5	028 040 310 0000	00	026 040 310		6.3	8	250		9	2.6	AO8	T
	6J6	882 345 100 0000	00	762 344 100		6.3	3	150		5	4.5	B7G	TT
	6J7	028 710 310 0000	40	026 510 310	G1	6.3	3	250	100	2	1.2	AO8	P
	6J8	020 048 310 0000	50	027 546 310	G1	6.3	3	100		3	1.6	AO8	TH
	6J8	028 740 310 0000	50	027 546 310	G1	6.3	3	100	100	1.3	1.2	AO8	TH
	6J9	861 238 485 0000	00	641 236 464		6.3	1	125		6	5.2	A10	TTT
	6J10	271 807 518 0430	00	-		6.3	3	100	100		9	A12	PP
	6J10	271 807 518 0430	00	-		6.3	8	250	250	35	6.5	A12	PP
	6J11	278 041 718 0530	00	-		6.3	0.8	125	125	11	13	A12	PP
	6JA8	148 231 578 0000	00	146 231 457		6.3	2	150		1	1.5	-	-
	6JA8	148 231 578 0000	00	146 231 457		6.3	1.5	150	150	18	13	B9A	TP
	6JB6	741 234 710 0000	80	541 234 51*	A1	6.3	22.5	250	150	70	7.1	B9D	P
	6JB8	857 238 114 0000	00	645 237 114		6.3	8.5	250		10.5	2.2	B9A	TP
	6J88	857 238 114 0000	00	645 237 114		6.3	3	250	100	3	1.6	B9A	TP
	6JC8	157 238 148 0000	00	145 237 146		6.3	1	150		12	6.5	B9A	TP
	6JC8	157 238 148 0000	00	145 237 146		6.3	1	150	125	9	5.5	B9A	TP
	6JD5	247 100 800 7430	00	-		6.3	10	125	125	1.0	55	A12	T
	6JD6	141 230 878 0000	00	141 230 656		6.3	0	125	125	15	14	B9A	P
	6JE6	741 234 710 0000	80	541 234 51*	A1	6.3	25	150	100	100	10	B9D	P
	6JE8	148 231 578 0000	00	146 231 457		6.3	2	200		4.5	4.2	B9A	TP
	6JE8	148 231 578 0000	00	146 231 457		6.3	2	200	175	22	12	B9A	TP
	6JF6	741 235 760 0000	80	541 234 550	A	6.3	20	130	125	80	10	B9D	P
	6JF8	210 741 390 0000	80	210 541 380	A1	6.3	22.5	250	150	75	6.6	AO8	DP
	6JG6	741 231 710 0000	00	541 231 5*6		6.3	20	130	125	80	10	B9D	P
	6JG6A	741 231 710 0000	00	541 231 506		6.3	20	130	125	80	10.0	B9A	P
	6JH6	412 387 100 0000	00	412 387 100		6.3	1	125	125	14	8	B7G	P
	6JH8	117 324 188 0000	00	115 324 166		6.3		250	250	14	4.4	B9A	P
	6JK6	412 387 100 0000	00	412 365 100		6.3	0.9	125	125	11.5	18	B7G	P
	6JK8	841 238 510 0000	00	741 236 410		6.3	1	100		5.3	6.8	B9A	TT
	6JK8	841 238 510 0000	00	741 236 410		6.3	1.2	150		10	13	B9A	TT
	6JL6	412 387 100 0000	00	412 365 100		6.3	0.9	125	60	12.5	15.5	B7G	P
	6JM6	217 140 000 1030	80	-		6.3	22.5	250	150	65	7.3	A12	P
	6JN6	217 100 800 1430	00	-		6.3	22.5	250	150	65	7.3	A12	P
	6JN8	481 238 715 0000	00	461 237 514		6.3	1	125		12	7.5	B9A	TP
	6JN8	481 238 715 0000	00	461 237 514		6.3	1	125	125	13.5	8.5	B9A	TP
	6JQ6	807 231 400 4000	00	605 231 100		6.3	18	140	140	25	4.2	B9A	P
	6JR6	741 236 708 0000	00	541 234 506		6.3	20	50	125	45	7.0	B9A	P
	6JS6	217 140 000 1730	00	-		6.3	27	175	125	100	11	A12	P
	6JS6A	217 040 000 0730	80	-		6.3	25	175	125	125	11.3	A12	P
	6JT6	741 231 708 0000	00	541 231 5*6		6.3	22.5	250	150	70	7.1	B9D	P
	6JT6A	741 231 708 0000	00	541 231 506		6.3	22.5	250	150	70	7.1	B9A	P
	6JT8	148 231 578 0000	00	146 231 457		6.3	2	250		1.5	2.7	B9A	TP
	6JT8	148 231 578 0000	00	146 231 457		6.3	1.6	200	100	17	20	B9A	TP
	6JU8	Z11 230 X11 0000	00	810 230 910		6.3				5		B9A	DDDD
	6JU8	ZY1 230 X91 0000	00	081 230 190		6.3				5		B9A	DDDD
	6JU8A	ZY1 230 X91 0000	00	981 230 761		6.3		10		60		B9A	DDDD
	6JV8	148 231 578 0000	00	146 231 457		6.3	2	200		4	4	B9A	TP
	6JV8	148 231 578 0000	00	146 231 457		6.3	2.9	200	200	22	11.5	B9A	TP
	6JW8	857 238 114 0000	00	645 237 114		6.3	2	200		3.5	3.5	B9A	TP
	6JW8	857 238 114 0000	00	645 237 114		6.3	1	100	100	6	5.5	B9A	TP
	6JZ6	217 040 000 0030	80	040 000 003		6.3	20	125	125	46	9	A12	P
	6JZ8	280 805 571 4130	00	-		6.3	5	150		5.5	23.	A12	TP
	6JZ8	280 805 571 4130	00	-		6.3	8	125	100	46	7.1	A12	TP
	6K1P	412 387 100 0000	00	412 365 100		6.3	1.5	250	100	6.5	2.0	B7G	DD
	6K4P	412 387 100 0000	00	412 365 100		6.3	1.0	250	100	11	4.4	B7G	P

SPEC.	VALVE TYPE NUMBER	PIN CONNECTIONS				CHARACTERISTICS						BASE	VALVE CLASS
		VCM163 Tester Only		CT160, VT160, VCM Mk 1,2,3,4		Vh	Vg1	Va	Vg2	la	gm mA/V		
		SELECTOR SWITCH	TOP CAP	SELECTOR SWITCH	TOP CAP	V	V	V	V	mA	†Ra MΩ		
	6K5	028 000 310 0000	40	026 000 310	G1	6.3	3	250		1.1	1.4	AO8	T
	6K6	028 740 310 0000	00	026 540 310		6.3	18	250	250	32	2.3	AO8	P
	6K7	028 710 310 0000	40	026 510 310	G1	6.3	3	250	100	10.5	1.5	AO8	P
	6K8	020 048 310 0000	50	027 546 310	G1	6.3	1	100		8	2.5	AO8	TH
	6K8	028 750 310 0000	50	027 546 310	G1	6.3	3	250	100	4	1.2	AO8	TH
	6K11	281 181 504 8630	00	-		6.3	8.5	250		10.5	2.2	A12	TTT
	6K11	281 181 504 8630	00	-		6.3	2.5	250		1.2	1.6	A12	TTT
	6K25	028 040 310 0000	00	026 040 310		6.3		100		30	2k	AO8	TH
	6KA8	841 235 178 0000	00	141 237 564		6.3	3	250		1.4	1.6	B9D	TP
	6KA8	841 235 178 0000	00	141 237 564		6.3	10	150	100	39	8.4	B9D	TP
	6KD5	217 040 004 0730	80	215 040 004		6.3	22.5	150	110	120	14	A12	P
	6KD6	217 040 004 0730	80	-		6.3	22.5	150	110	120	14	A12	P
	6KD8	857 238 114 0000	00	645 237 114		6.3	1	125		13.5	7.5	B9A	TP
	6KD8	857 238 114 0000	00	645 237 114		6.3	1	125	100	9	5	B9A	TP
	6KE8	857 238 114 0000	00	645 237 114		6.3	1	125		13	8	B9A	TP
	6KE8	857 238 114 0000	00	645 237 114		6.3	0.4	125	125	10	10	B9A	TP
	6KF8	170 231 481 0000	00	156 231 471		6.3	1	150	150	4	1	B9A	PP
	6KF8	178 231 501 0000	00	156 231 471		6.3	1	150	150	4	1	B9A	PP
	6KH2P	192 310 X00 0000	00	182 310 900		6.3				5.0		B7G	RR
	6KM8	889 231 478 0000	00	668 231 456		6.3		100	100	4.2	3.4	B9A	DP
	6KN6	217 140 000 1030	00	-		6.3	20	125	125	100	16	A12	P
	6KR8	148 231 578 0000	00	146 231 457		6.3	1	100		15	10.4	B9A	TP
	6KR8	148 231 578 0000	00	146 231 457		6.3	2	200	100	19.5	20	B9A	TP
	6KT8	148 321 578 0000	00	146 231 457		6.3	2	250		1.8	3.2	B9A	TP
	6KT8	148 321 578 0000	00	146 231 457		6.3	1	125	125	12	10	B9A	TP
	6KU8	1X9 231 478 0000	00	189 231 456		6.3	1.6	200	100	17	20	B9A	DDP
	6KV6	741 231 708 0000	00	541 231 506		6.3	25	150	150	80	9.5	B9A	P
	6KV8	148 231 578 0000	00	146 231 457		6.3	1.8	200		4	4	B9A	TP
	6KV8	148 231 578 0000	00	146 231 457		6.3	1.6	200	125	20	23	B9A	TP
	6KY8	151 238 784 0000	00	-		6.3	3	250		1.4	1.6	B9D	TP
	6KY8	151 238 784 0000	00	-		6.3	10	150	100	39	8.4	B9D	TP
	6KZ8	851 238 715 0000	00	641 237 514		6.3	1.0	150		13.5	8.5	B9A	TP
	6KZ8	851 238 715 0000	00	641 237 514		6.3	1.0	150	150	12	7.5	B9A	TP
	6L1	285 184 130 0000	00	274 164 130		6.3	8.6	200		10	2.8	B8A	TT
	6L5	028 040 310 0000	00	026 040 310		6.3	9	250		8	1.9	AO8	T
	6L6	028 740 310 0000	00	026 540 310		6.3	18	350	250	54	5.2	AO8	P
	6L7	028 740 310 0000	40	026 540 310	G1	6.3	3	250	100	6.3	1.1	AO8	H
	6L10	120 417 380 0000	00	120 415 360		6.3	3	300	150	30	11	B8A	P
	6L12	851 238 410 0000	00	741 236 410		6.3	2.3	250		10	5.9	B9A	TT
	6L13	851 228 413 0000	00	741 226 413		6.3	2	250		1.2	1.6	B9A	TT
	6L15	158 234 118 0000	00	147 234 116		6.3	1.2	90		15	9	B9A	TT
	6L16	148 235 108 0000	00	146 234 107		6.3	1.5	90		12	6.2	B9A	TT
	6L18	280 084 130 0000	00	260 064 130		6.3	13.3	250		12	5.5	B8A	T
	6L19	285 184 130 0000	00	274 164 130		6.3	1.8	200		5	3.1	B8A	TT
	6L31	412 387 400 0000	00	412 365 400		6.3	12.5	250	250	45	4.1	B7G	P
	6L34	412 314 800 0000	00	412 314 600		6.3	1.5	250		10	9	B7G	T
	6L41	801 237 144 0000	00	602 235 144		6.3	17.2	250	250	45	7	B9A	P
	6L43	147 238 174 0000	00	145 236 154		6.3	3	300	150	30	11	B9A	P
	6L50	214 471 130 0000	80	214 451 130	A1	6.3	12.6	200	250	70	5	B9A	P
	6L50V	217 447 113 0000	80	215 445 113	A1	6.3	25	400	250	30	3.5	B9A	P
	6LB6	217 540 000 5730	80	-		6.3						A12	P
	6LB6	217 540 000 5730	80	-		6.3	20	150	110	105	13.4	A12	P
	6LB8	148 231 578 0000	00	146 231 456		6.3	0.9	125		13	5	B9A	TP
	6LB8	148 231 578 0000	00	146 231 456		6.3	1.6	200	100	17	20	B9A	TP

SPEC.	VALVE TYPE NUMBER	PIN CONNECTIONS				CHARACTERISTICS						BASE	VALVE CLASS
		VCM163 Tester Only		CT160, VT160, VCM Mk 1,2,3,4		Vh	Vg1	Va	Vg2	la	gm mA/V		
		SELECTOR SWITCH	TOP CAP	SELECTOR SWITCH	TOP CAP	V	V	V	V	mA	†Ra MΩ		
	6LC8	841 235 178 0000	00	641 234 157		6.3	2	200		4	4	B9A	TP
	6LC8	841 235 178 0000	00	641 234 157		6.3	1.2	150	100	4	4.4	B9A	TP
	6LD3	284 0X9 130 0000	00	264 098 130		6.3	1.9	250		0.85	1.95	B8A	DDT
	6LD12	YX1 239 148 0000	00	†91 238 146		6.3	1.0	100		0.8	1.45	B9A	DDDT
	6LD13	841 239 0X0 0000	00	641 238 09*		6.3	1.9	250		0.85	1.2	B9A	DDT
	6LD20	284 0X9 130 0000	00	264 098 130		6.3	5.9	250		5	2.3	B8A	DDT
	6LE8	811 230 174 0000	00	611 230 154		6.3	2.5	100	100	8	5.8	B9A	PP
	6LE8	011 238 174 0000	00	611 230 154		6.3	2.5	100	100	8	5.8	B9A	PP
	6LF8	148 231 578 0000	00	146 231 456		6.3	2	200		4	4	B9A	TP
	6LF8	148 231 578 0000	00	146 231 456		6.3	2.5	100	150	20	11	B9A	TP
	6LFD12	741 238 9X1 0000	00	541 236 891		19	2	150	100	9	3.8	B9A	DDP
	6LJ8	481 238 715 0000	00	461 236 514		6.3	0.7	125		13	8	B9A	TP
	6LJ8	481 238 715 0000	00	461 236 514		6.3	0.5	125	125	12	13	B9A	TP
	6LM8	800 230 014 0000	00	600 230 140		6.3	0	330		13.5	8.5	B9A	T
	6LM8	047 238 100 0000	00	045 230 610		6.3	0	350	330	12	6.0	B9A	T
	6LQ8	148 230 000 0000	00	146 230 000		6.9	0	125	125	15	3.1	B9A	PT
	6LQ8	000 231 478 0000	00	000 231 456		6.9	0	200	125	20	3.5	B9A	PT
	6LR6	217 140 000 1730	80	-		6.3	0	60	220	740	16	A12	TP
	6LR8	151 238 784 0000	00	141 236 564		6.3	4	250		2.3	3.6	B9A	TP
	6LR8	151 238 784 0000	00	141 236 564		6.3	10	150	125	56	9.3	B9A	TP
	6LU8	280 805 571 4130	00	-		6.3	4	250		2.3	3.6	A12	TP
	6LU8	280 805 571 4130	00	-		6.3	10	150	125	56	9.3	A12	TP
	6LY8	148 230 000 0000	00	146 230 000		6.3	2.0	19.5	100	19.5	20	B9A	P
	6LY8	000 231 478 0000	00	146 230 000		6.3	2.0	1.0	0	1	1.7	B9A	P
	6M1	028 740 310 0000	00	026 540 310		6.3	22.5	250	250	0.2	†1.0	AO8	TI
	6M2	027 478 310 0000	00	*25 456 310		6.3	4	250	250	0.12	†0.2	AO8	TI
	6M2	027 478 310 0000	00	*25 456 310		6.3	2	250	250	0.25	†0.1	AO8	TI
	6M3	029 000 030 0000	10	*28 0*0 *30	C	6.3						AO8	R
	6M5	741 230 800 0000	00	541 230 600		6.3	7	250	250	36	10	B9A	P
	6M6	028 740 310 0000	00	026 540 310		6.3	6	250	250	36	9.5	AO8	P
	6M7	028 710 310 0000	40	026 510 310	G1	6.3	2.5	250	125	10.5	3.4	AO8	P
	6M8	138 748 290 0000	50	137 546 280	G1	6.3	1	100		0.5	1.1	AO8	DTP
	6M8	138 748 290 0000	50	137 546 280	G1	6.3	3	100	100	8.5	1.9	AO8	DTP
	6M11	267 158 841 0830	00	2*5 146 641		6.3	2	250		10	5.5	A12	TTP
	6M11	267 158 841 0830	00	2*5 146 641		6.3	0.8	150		11	14	A12	TTP
	6M40	410 230 807 0000	00	410 230 605		6.3	20	250		0.5	†1.0	B9A	TI
	6MB8	481 237 516 0000	00	461 230 000		6.3	0	125		13	8.0	B9A	T
	6MB8	481 237 516 0000	00	200 236 514		6.3	0	125	125	10	12	B9A	T
	6MD3	901 390 100 0000	00	802 380 100		6.3				10		B7G	R
	6MD4	102 310 900 0000	00	102 310 800		6.3						B7G	D
	6MD8	YX9 234 156 0000	00	996 234 144		6.3	10.5	250		11.5	3.1	B9A	TTT
	6ME8	XY7 234 168 0000	00	895 234 167		6.3	16	250		1.3	4.4	B9A	DT
	6ME8	XY7 234 168 0000	00	895 234 167		6.3	16	250		1.3	4.4	B9A	DT
	6MF8	280 000 000 4130	00	-		6.3	4	250	0	2.6	4.1	A12	P
	6MF8	200 804 560 0030	00	-		6.3	20	250	250	50	4.1	A12	P
	6MH1	412 344 800 0000	00	412 344 600		6.3		150		14.5	13	B7G	T
	6MHH3	882 345 100 0000	00	672 344 100		6.3	1	100		11	7.5	B7G	TT
	6MJ8	2X1 908 040 5630	00	-		6.3	10.5	250		10.0	3.0	A12	TTT

SPEC.	VALVE TYPE NUMBER	PIN CONNECTIONS				CHARACTERISTICS						BASE	VALVE CLASS
		VCM163 Tester Only		CT160, VT160, VCM Mk 1,2,3,4		Vh	Vg1	Va	Vg2	la	gm mA/V		
		SELECTOR SWITCH	TOP CAP	SELECTOR SWITCH	TOP CAP	V	V	V	V	mA	†Ra MΩ		
	6M-L2	842 384 100 0000	00	642 364 100		6.3	4.5	150		14	5	B7G	T
	6M-L4	842 314 800 0000	00	642 314 600		6.3		100		17	6.5	B7G	T
	6MK7	028 710 310 0000	40	026 510 310	G1	6.3	2	250	100	5	2.3	AO8	P
	6MK8	178 239 589 0000	00	159 231 481		6.3	0.0	100	67.5	0		E9-1	DP
	6MK8	178 239 589 0000	00	159 231 481		6.3	5.0	100	63.5	2.0		E9-1	DP
	6MN8	2Y1 X09 040 5630	00	-		6.3	0	200		4.5	4.0	A12	TP
	6MN8	2Y1 X09 040 5630	00	-		6.3	0	125		11.0	7.5	A12	TP
	6MP2	412 387 000 0000	00	412 365 000		6.3	6	200	175	25	5.5	B7G	P
	6MP17	412 387 400 0000	00	412 365 400		6.3	8	250	250	32	5.2	B7G	P
	6MU8	800 230 014 0000	00	600 230 014		0.6	0	125		11.5	6.0	B9A	TP
	6MU8	047 238 100 0000	00	045 236 000		0.6	0	150	150	9.0	9.0	B9A	TP
	6IM1P	841 238 410 0000	00	641 237 410		6.3	4.8	250		8	4.3	B9A	T
	6N2P	841 228 413 0000	00	641 237 410		6.3	1.5	250		2.3	2	B9A	T
	6N3	001 230 009 0000	00	**1 23* **8		6.3				180		B9A	R
	6N4	412 381 400 0000	00	412 361 400		6.3	3	200		12	6	B7G	T
	6N5	284 713 000 0000	00	264 513 000		6.3	15.3	150	150	0.2	†1.0	UX6	TI
	6N6	028 850 310 0000	00	020 610 310		6.3	0	300		9		AO8	TT
	6N6	028 850 310 0000	00	020 610 310		6.3		300		42	2.5	AO8	TT
	6N6P	841 238 410 0000	00	641 237 410		6.3	2	125		30	10	B9A	TT
	6N7	028 548 310 0000	00	027 446 310		6.3	5	250		3	1.6	AO8	TT
	6N7	028 710 310 0000	40	026 510 310	G1	6.3	2.5	250	125	10.5	3.4	AO8	P
	6N8	741 238 9X1 0000	00	541 236 891		6.3	2	250	90	5	2.2	B9A	DDP
	6N15P	882 345 100 0000	00	762 344 100		6.3	2	100		8.5	5.6	B7G	TT
	6NK7	028 710 310 0000	40	026 510 310	G1	6.3	2.5	250	125	10.5	3.4	AO8	P
	6NK8	841 238 510 0000	00	641 237 410		6.3		100		16	16	B9A	TT
	6P1	028 740 310 0000	00	026 540 310		6.3	8.5	250	250	30	8.8	AO8	P
	6P2	412 387 100 0000	00	412 365 100		6.3	68	250	150	10.6	5.2	B7G	P
	6P5	028 040 310 0000	00	026 040 310		6.3	13.5	250		5	1.25	AO8	T
	6P6	217 413 000 0000	80	215 413 000	A1	6.3	8	250	150	34		UX6	P
	6P7	023 878 410 0000	50	023 756 410	G1	6.3	3	100		3.5	0.5	AO8	TP
	6P7	023 878 410 0000	50	023 756 410	G1	6.3	3	100	100	6.3	1	AO8	TP
	6P8	020 748 310 0000	50	027 546 310	G1	6.3		100		2.2		AO8	TH
	6P8	028 750 310 0000	50	027 546 310	G1	6.3	8	250	75	2.2	0.7	AO8	TH
	6P9	412 387 400 0000	00	412 366 400		6.3	6	250	250	30	7	B9A	P
	6P15	041 230 807 0000	00	*41 23* 6*5		6.3	7.5	250	250	49	11.3	B9A	P
	6P17	412 380 700 0000	00	412 360 500		6.3	13.5	250	250	16	2.6	B7G	P
	6P28	020 740 310 0000	80	020 540 310	A1	6.3	8.8	350	250	72	9.5	AO8	P
	6P1P	871 238 417 0000	00	651 230 400		6.3	12.5	250	250	45	4.5	B9A	P
	6P2P	412 387 100 0000	00	412 365 000		6.3	5.5	125	125	35	8	B7G	P
	6P4P	902 310 X00 0000	00	802 310 900		6.3				30		B7G	RR
	6PL12	415 238 718 0000	00	414 237 516		6.3		100		3.5	2.5	B9A	P
	6PL12	415 238 718 0000	00	414 237 516		6.3	8.5	250	250	40	8.8	B9A	P
	6PX6	028 740 310 0000	00	026 540 310		6.3	6	250		35	9.2	AO8	P
	6PZ8	028 7X9 310 0000	40	026 598 310	G1	6.3	6	250	250	36	9.2	AO8	DDP
	6Q4	441 230 448 0000	00	441 230 446		6.3	1.5	250		15	12	B9A	T
	6Q6	028 090 310 0000	00	026 080 310		6.3	3	250		1.2	1.05	AO8	DT
	6Q7	028 X90 310 0000	40	026 980 310	G1	6.3	3	250		1	1.2	AO8	DDT
	6Q11	281 181 514 8630	00	-		6.3		150		2.2	2.5	A12	TTT
	6Q11	281 181 514 8630	00	-		6.3	2.0	250		1.2	1.6	A12	TTT
	6QL6	741 238 174 0000	00	541 236 154		6.3	11.5	200	175	52	9.5	B9A	P
	6R	028 710 310 0000	40	026 510 310	G1	6.3	2	250	100	3.7	2	AO8	P
	6R4	410 230 080 0000	00	401 230 060		6.3	2	150		30	5.5	B9A	T
	6R6	028 700 310 0000	40	026 500 310	G1	6.3	3	250	100	7	1.45	AO8	P
	6R7	028 X90 310 0000	40	026 980 310	G1	6.3	9	250		9.5	1.9	AO8	DDT
	6R8	9Y1 23X 148 0000	00	8†1 239 146		6.3	9	250		9.5	1.9	B9A	DDDT
	6R51P	471 230 807 0000	00	451 23* 6*5		6.3	8	250	250	54	11	B9A	P
	6RA2	014 234 008 0000	00	014 234 006		6.3	31	150		100	8.5	B9A	P
	6RA3	808 032 041 0000	00	606 032 041		6.3	70	250		45	4.5	B9A	T



SPEC.	VALVE TYPE NUMBER	PIN CONNECTIONS				CHARACTERISTICS						BASE	VALVE CLASS
		VCM163 Tester Only		CT160, VT160, VCM Mk 1,2,3,4		Vh	Vg1	Va	Vg2	la	gm mA/V		
		SELECTOR SWITCH	TOP CAP	SELECTOR SWITCH	TOP CAP	V	V	V	V	mA	†Ra MΩ		
6RA5	808 032 041 0000	00		606 032 041		6.3	20	100		80	11	B9A	T
6RA8	014 234 008 0000	00		014 234 006		6.3	21	300	300	75	9	B9A	P
6RB11	704 234 108 0000	00		504 234 106		6.3	12.5	200	200	45	7.5	B9A	P
6R-DHV1	157 328 984 0000	00		145 327 864		6.3	2	250		1.2	1.6	B9A	DTP
6R-DHV1	157 328 984 0000	00		145 327 864		6.3	1	250	100	9	3.5	B9A	DTP
6RHH2	851 238 410 0000	00		741 236 410		6.3	1	90		8.5	8	B9A	TT
6R-HH8	841 238 510 0000	00		641 237 410		6.3		100		16	16	B9A	TT
6RHV1	157 238 184 0000	00		145 237 164		6.3	2	250		12	1.6	B9A	TP
6RHV1	157 238 184 0000	00		145 237 164		6.3	1	250	100	9	3.5	B9A	TP
6RK19	000 230 009 0000	10		*** 23* **8	C1	6.3				120		B9A	R
6RP10	280 173 041 0000	00		260 153 041		6.3	2.6	150	150	36	13.5	B9A	P
6RP15	471 230 807 0000	00		451 23* 6*5		6.3	8	250	250	59	11	B9A	P
6RR8	402 108 073 0000	00		402 106 053		6.3		150	150	13	12.6	B9A	P
6RR21	741 238 9X1 0000	00		541 236 891		6.3		150	150	13.5	15	B9A	DDP
6RV	028 710 310 0000	40		026 510 310	G1	6.3	2	250	100	6.4	2.1	AO8	P
6S1P	812 384 100 0000	00		612 304 000		6.3	7	250		6.3	2.2	B7G	T
6S2	000 230 000 0000	90		230 232 032	D1	6.3						B9A	R
6S2P	412 344 800 0000	00		412 300 600		6.3	1	100		10	11	B7G	T
6S2A	000 230 000 0000	90		*** 23* ***	D1	6.3						B9A	D
6S4	010 234 008 0000	00		*1* 234 **6		6.3	8	250		26	4.5	B9A	T
6S4A	014 234 008 0000	00		014 234 006		6.3	-8	250		24	4.5	B9A	T
6S5	028 370 310 0000	00		026 470 310		6.3	8	250		0.23	†1.0	AO8	TI
6S6	120 800 370 0000	40		120 600 350	G1	6.3	2	250	100	13	4	AO8	P
6S7	028 710 310 0000	40		026 510 310	G1	6.3	3	250	100	8.5	1.75	AO8	P
6S8	Y19 X18 230 0000	40		118 916 230	G1	6.3	2	250		0.9	1.1	AO8	DDDT
6SA7	128 841 310 0000	00		126 641 310		6.3	3.6	100		12	4.3	AO8	H
6SC5	028 400 310 0000	00		026 400 310		6.3	4	250		7.5	2.7	AO8	T
6SC7	085 481 230 0000	00		074 461 230		6.3	2	250		2	1.3	AO8	TT
6SD7	021 417 380 0000	00		021 415 360		6.3	2	250	100	6	3.6	AO8	P
6SE7	021 417 380 0000	00		021 415 360		6.3	1.5	250	100	4.5	3.4	AO8	P
6SF5	014 080 320 0000	00		014 060 320		6.3	2	250		0.9	1.5	AO8	T
6SF7	041 791 380 0000	00		041 581 360		6.3	1	250	100	12.4	2.05	AO8	DP
6SG7	021 417 380 0000	00		021 415 360		6.3	1	250	125	11.8	4.7	AO8	P
6SH7	021 417 380 0000	00		021 415 360		6.3	1	250	150	10.8	4.9	AO8	P
6SJ7	021 417 380 0000	00		021 415 360		6.3	3	250	100	3	1.65	AO8	P
6SJ8EG	028 748 310 0000	40		027 546 310	G1	6.3	3	150		5	1.6	AO8	TH
6SJ8EG	028 750 310 0000	40		027 546 310	G1	6.3	3	150	100	1.3	1.2	AO8	TH
6SJ8G	028 748 310 0000	50		021 415 360		6.3	3	250	100	9.2	2	AO8	P
6SJ8G	028 750 310 0000	50		021 415 360		6.3	3	250	100	9.2	2	AO8	P
6SK7	021 417 380 0000	00		021 415 360		6.3	3	250	100	9.2	2	AO8	P
6SL7	481 581 230 0000	00		461 471 230		6.3	2	250		2.3	1.6	AO8	TT
6SN7	481 581 230 0000	00		461 471 230		6.3	8	250		9	2.9	AO8	TT
6SQ7	041 9X8 230 0000	00		041 896 230		6.3	2	250		0.9	1.1	AO8	DDT
6SR7	041 X98 230 0000	00		041 986 230		6.3	9	250		9.5	1.9	AO8	DDT
6SS7	021 417 380 0000	00		021 415 360		6.3	3	250	100	9	1.85	AO8	P
6ST7	041 9X8 230 0000	00		041 896 230		6.3	9	250		9.5	1.9	AO8	DDT
6SU7	581 481 230 0000	00		471 461 230		6.3	2	250		2.3	1.6	AO8	TT
6SV7	041 798 230 0000	00		941 586 230		6.3	1	250	150	7.5	3.4	AO8	DP
6SZ7	041 X98 230 0000	00		041 986 230		6.3	3	250		1	1.2	AO8	DDT
6T	207 413 000 0000	80		205 413 000	A1	6.3	12.5	250	250	4.5	4.1	UX6	P
6T1	841 314 800 0000	00		642 314 600		6.3		75		16	6.6	B7G	T
6T4	842 314 800 0000	00		642 314 600		6.3	3	80		18	7	B7G	T

SPEC.	VALVE TYPE NUMBER	PIN CONNECTIONS				CHARACTERISTICS						BASE	VALVE CLASS
		VCM163 Tester Only		CT160, VT160, VCM Mk 1,2,3,4		Vh	Vg1	Va	Vg2	la	gm mA/V		
		SELECTOR SWITCH	TOP CAP	SELECTOR SWITCH	TOP CAP	V	V	V	V	mA	†Ra MΩ		
	6T5	284 713 000 0000	00	264 513 000		6.3	22	250	250		†1.0	UX6	TI
	6T6	028 700 310 0000	40	026 500 310	G1	6.3	1	250	100	10	5.5	AO8	P
	6T7	028 X90 310 0000	40	026 980 310	G1	6.3	3	250		1.2	1	AO8	DDT
	6T8	YX1 239 148 0000	00	†91 238 146		6.3	3	250		1	1.2	B9A	DDDT
	6T9	280 410 051 7830	00	-		6.3	2	250		1.5	2.1	A12	TP
	6T9	280 410 051 7830	00	-		6.3	8	250	250	37	6.5	A12	TP
	6T10	215 017 841 7830	00	-		6.3	8	250	250	37	6.5	A12	PP
	6T10	215 017 841 7830	00	-		6.3	1.8	150	100	1.3	1	A12	PP
	6T24	848 230 115 0000	00	647 230 114		6.3	2	150		17	7	B9A	TT
	6T26	841 238 510 0000	00	641 237 410		6.3	2.3	250		10	6	B9A	TT
	6T27	841 238 510 0000	00	641 237 410		6.3		150		10	6.8	B9A	TT
	6TD32	9X1 23Y 148 0000	00	891 230 146		6.3	3	250		1	1.2	B9A	DDT
	6TD33	9X1 23Y 148 0000	00	891 230 146		6.3	3	250		2.2	2.1	B9A	DDDT
	6TE8	728 148 310 0000	50	427 146 310	G1	6.3	2	100		3.7		AO8	TH
	6TE8	728 148 310 0000	50	427 146 310	G1	6.3	2	250	100	3.5		AO8	TH
	6TE9	801 230 450 0000	00	651 237 440		6.3		100		4	2	B9A	TH
	6TE9	071 238 550 0000	00	651 237 440		6.3	2.5	200	90	3	0.7	B9A	TH
	6TH8	028 748 310 0000	50	027 546 310	G1	6.3	7	150		6	1.1	AO8	TH
	6TH8	028 750 310 0000	50	027 546 310	G1	6.3	1.5	200	75	3.5		AO8	TH
	6TP	207 413 000 0000	80	205 413 000	A1	6.3	14.5	250	250	12	6	UX6	P
	6TP1	857 238 114 0000	00	645 237 114		6.3		150		18	8.5	B9A	TP
	6TP1	857 238 114 0000	00	645 237 114		6.3	68	250	100	10	5.2	B9A	TP
	6TP3	841 238 175 0000	00	641 237 154		6.3	2	100		4	2	B9A	TP
	6TP3	841 238 175 0000	00	641 237 154		6.3	3	200	100	8	3	B9A	TP
	6TP4	157 238 814 0000	00	145 237 614		6.3		150		18	8.5	B9A	TP
	6TP4	157 238 814 0000	00	145 237 614		6.3	68	250	100	10	5.2	B9A	TP
	6TP5	751 328 184 0000	00	541 327 164		6.3		100		2.2	1.3	B9A	TP
	6TP5	751 328 184 0000	00	541 327 164		6.3		200	100	9		B9A	TP
	6U3	001 230 009 0000	00	**1 23* **8		6.3				180		B9A	R
	6U4	001 090 230 0000	00	001 080 230		6.3				120		AO8	R
	6U5	028 740 310 0000	00	026 540 310		6.3	8	250				AO8	TI
	6U5/6G5	284 713 000 0000	00	264 513 000		6.3	22	250	250	0.2	†1.0	UX6	TI
	6U5M	029 0X0 310 0000	00	028 090 310		6.3				30		AO8	RR
	6U6	028 740 310 0000	00	026 540 310		6.3	14	200	150	56	6.2	AO8	P
	6U7	028 710 310 0000	40	026 510 310	G1	6.3	3	250	100	8	1.5	AO8	P
	6U8	857 238 114 0000	00	645 237 114		6.3	1	150		18	8.5	B9A	TP
	6U8	857 238 114 0000	00	645 237 114		6.3	1	250	100	10	5.2	B9A	TP
	6U9	115 123 878 4000	00	-		6.3	2	100		14	5		T
	6U9	115 123 878 4000	00	-		6.3	1.4	175	125	13	12		P
	6U10	281 181 504 8630	00	-		6.3	6	200		9.6	2.3	A12	TTT
	6U10	281 181 504 8630	00	-		6.3	1.5	200		1.2	1.6	A12	TTT
	6UG56	028 740 310 0000	-	026 540 310		6.3	8	250	250		†0.1	AO8	TI
	6V3	092 230 909 0000	10	082 230 808	C	6.3				120		B9A	RR
	6V4	901 230 X00 0000	00	9*1 23* 8**		6.3				30		B9A	R
	6V5	008 740 230 0000	00	006 540 230		6.3	12.5	250	250	45	4.1	AO8	P
	6V6	028 740 310 0000	00	026 540 310		6.3	12.5	250	250	45	4.1	AO8	P
	6V7	028 X90 310 0000	40	026 980 310	G1	6.3	20	250		8	1.1	AO8	DDT
	6V8	891 234 Y1X 0000	00	681 234 †19		6.3	3	250		1	1.2	B9A	DDDT
	6W2	023 000 000 0000	90	023 000 000	D1	6.3						B3G	D
	6W3	001 230 009 0000	00	**1 23* **8		6.3				20		B9A	R
	6W4	001 090 230 0000	00	001 080 230		6.3				120		AO8	R
	6W5	029 0X0 310 0000	00	028 090 310		6.3				60		AO8	RR
	6W6	028 740 310 0000	00	026 540 310		6.3	9.5	150	150	58	8	AO8	P
	6W7	028 710 310 0000	40	026 510 310	G1	6.3	3	250	100	2	1.2	AO8	P

SPEC.	VALVE TYPE NUMBER	PIN CONNECTIONS				CHARACTERISTICS						BASE	VALVE CLASS
		VCM163 Tester Only		CT160, VT160, VCM Mk 1,2,3,4		Vh	Vg1	Va	Vg2	la	gm mA/V		
		SELECTOR SWITCH	TOP CAP	SELECTOR SWITCH	TOP CAP	V	V	V	V	mA	†Ra MΩ		
	6WC5	288 114 300 0000	00	266 114 300		6.3	3.6	100		12	4.3	B7G	H
	6X2	023 000 000 0000	90	023 000 000	D1	6.3						B3G	D
	6X3	020 000 310 0000	90	020 000 310	D1	6.3				5		AO8	R
	6X4	902 30X 100 0000	00	802 309 100		6.3				30		B7G	RR
	6X5	029 0X0 310 0000	00	028 090 310		6.3				30		AO8	RR
	6X6	027 740 310 0000	00	025 540 310		5		250	250			AO8	T1
	6X8	148 231 578 0000	00	146 231 457		6.3	1	100		8.5	5.8	B9A	TP
	6X8	148 231 578 0000	00	146 231 457		6.3	1.8	250	150	7.5	4.6	B9A	TP
	6X9	115 123 878 4000	00	-		6.3	1	170		8.5	4.8		TP
	6X9	115 123 878 4000	00	-		6.3	1.7	175	150	14	13		TP
	6Y3	030 000 200 0000	90	030 000 200	D1	6.3				5		AO8	R
	6Y5	209 1X3 000 0000	00	208 193 000		6.3				30		UX6	RR
	6Y6	028 740 310 0000	00	026 540 310		6.3	13.5	150	150	58	7	AO8	P
	6Y6-GA	028 743 100 0000	00	026 543 100		6.3	.14	135	135	61	7.0	AO8	P
	6Y6-GA	028 743 100 0000	00	026 543 100		6.3					7.1	AO8	P
	6Y7	028 458 310 0000	00	027 446 310		6.3	0	250		5.3	1.8	AO8	TT
	6Y9	517 823 147 8000	00	-		6.3	2.6	175	175	30	21		P
	6Y9	517 823 147 8000	00	-		6.3	2.3	150	150	10	8.5		P
	6Y50	902 309 001 0000	00	802 308 001		6.3				180		B9A	R
	6Z3	391 200 000 0000	00	381 200 000		6.3				60		UX4	R
	6Z4	29X 130 000 0000	00	289 130 000		6.3				30		UX5	RR
	6Z5	329 1X2 000 0000	00	328 192 000		6.3				30		UX6	RR
	6Z6	029 1X0 310 0000	00	028 190 310		6.3				30		AO8	RR
	6Z7	028 458 310 0000	00	026 447 310		6.3	0	200		4.2	0.5	AO8	TT
	6Z31	902 30X 100 0000	00	802 309 100		6.3				30		B7G	RR
	6Z40	000 230 009 0000	10	000 230 008	C	6.3				120		B9A	R
	6ZDH3A	284 913 000 0000	00	264 813 000		6.3	2	250		1.5		UX6	DT
	6ZE1	284 713 000 0000	00	264 513 000		6.3	7	250			†1.0	UX6	TI
	6ZH1P	412 387 100 0000	00	412 365 100		6.3	2.2	125	125	5.5	3.5	B7G	P
	6ZH2P	412 387 100 0000	00	412 365 100		6.3	2.2	125	125	7.5	5.2	B7G	P
	6ZH3P	412 387 100 0000	00	412 365 100		6.3	2	250	150	7	5	B7G	P
	6ZH4P	412 387 100 0000	00	412 365 100		6.3	1	250	100	11	4.4	B7G	P
	6ZH5P	412 387 100 0000	00	412 365 100		6.3	2	250	100	10	9	B7G	P
	6ZP1	287 413 000 0000	00	265 413 000		6.3	9	200	200	15	1.7	UX6	P
	6ZY5	029 0X0 310 0000	00	028 090 310		6.3				15		AO8	RR
	7A2	047 231 800 0000	00	045 231 600		4	17	250	250	40	3.2	B7	P
	7A3	045 231 800 0000	00	045 231 600		4	6	250	250	32	10	B7	P
	7A4	280 004 130 0000	00	260 0*4 130		6.3	8	250		9	2.6	B8B	T
	7A5	287 004 130 0000	00	265 004 130		6.3	9	150	125	44	6	B8B	P
	7A6	21X 009 130 0000	00	219 008 130		6.3				5		B8B	RR
	7A7	287 104 130 0000	00	265 104 130		6.3	3	250	100	9.2	2	B8B	P
	7A8	288 471 130 0000	00	266 451 130		6.3	1	250	100	14	1.4	B8B	O
	7AB7	728 141 310 0000	00	526 141 310		6.3	2	250	100	4	1.8	B8B	P
	7AC7	412 387 100 0000	00	412 365 100		6.3		300	150	10	9	B7G	P
	7AD7	287 104 130 0000	00	265 104 130		6.3	2.3	300	150	28	9.5	B8B	P
	7AF7	218 548 130 0000	00	217 446 130		6.3	9	250		9	2.1	B8B	TT
	7AG7	287 114 130 0000	00	265 114 130		6.3	2	250	250	6	4.2	B8B	P
	7AH7	287 114 130 0000	00	265 114 130		6.3	2	250	250	6.8	3.3	B8B	P
	7AJ7	287 104 130 0000	00	265 104 130		6.3	3	250	100	2.2	1.5	B8B	P
	7AK7	287 104 130 0000	00	265 104 130		6.3	0	150	90	40	6.5	B8B	P
	7AN7	158 234 118 0000	00	147 234 116		7.5	1	90		12	6	B9A	TT
	7AU7	851 228 413 0000	00	741 226 413		3.5	8.5	250		10.5	2.2	B9A	TT
	7B4	280 004 130 0000	00	260 004 130		6.3	2	250		0.9	1.5	B8B	T
	7B5	287 004 130 0000	00	265 004 130		6.3	18	250	250	32	2.3	B8B	P
	7B6	284 0X9 130 0000	00	264 *98 130		6.3	2	250		0.9	1.1	B8B	DDT

SPEC.	VALVE TYPE NUMBER	PIN CONNECTIONS				CHARACTERISTICS						BASE	VALVE CLASS
		VCM163 Tester Only		CT160, VT160, VCM Mk 1,2,3,4		Vh	Vg1	Va	Vg2	Ia	gm mA/V		
		SELECTOR SWITCH	TOP CAP	SELECTOR SWITCH	TOP CAP	V	V	V	V	mA	†Ra MΩ		
	7B7	287 104 130 0000	00	265 104 130		6.3	3	250	100	8.5	1.7	B8B	P
	7B8	287 474 130 0000	00	265 454 130		6.3	2	250	100		1.1	B8B	H
	7C4	200 900 130 0000	00	2*0 800 130		6.3				5		AO8	R
	7C5	287 004 130 0000	00	265 004 130		6.3	12.5	250	250	45	4.1	B8B	P
	7C6	284 1X9 130 0000	00	264 198 130		6.3	1	250		1.3	1	B8B	DDT
	7C7	287 114 130 0000	00	265 114 130		6.3	3	250	100	2	1.3	B8B	P
	7CE40	148 235 118 0000	00	146 234 117		7	1.5	90		12	6	B9A	TT
	7D3	047 231 800 0000	00	045 231 600		40	20	150	125	36	2.4	B7	P
	7D5	047 231 800 0000	00	045 231 600		13	16.5	250	250	34	2.3	B7	P
	7D6	047 231 800 0000	00	045 231 600		40	6	250	250	32	10	B7	P
	7D7	208 405 130 0000	00	276 454 130		6.3	3	150		3		B8B	TH
	7D7	280 575 130 0000	00	276 454 130		6.3	3	250	100	1.3	0.2	B8B	TH
	7D8	047 231 800 0000	00	045 231 600		13	6	250	250	32	10	B7	P
	7D9	412 380 700 0000	00	412 360 500		6.3	13.5	250	250	16	2.6	B7G	P
	7D9	047 231 800 0000	00	045 231 600		13	25	250	250	32	1.8	B7	P
	7D10	041 230 871 0000	00	*41 230 651		6.3	4.5	250	250	40	11	B8A	P
	7D11	028 740 310 0000	00	026 540 310		6.3	20	350	250	95	9	AO8	P
	7DJ8	841 238 510 0000	00	641 237 411		7	1.3	90		15	12.5	B9A	TT
	7E5	428 141 830 0000	00	426 141 630		6.3	3	200		5.5	3	B8B	T
	7E6	284 0X9 130 0000	00	264 *98 130		6.3	8	250		9.5	1.9	B8B	DDT
	7E7	28X 974 130 0000	00	269 854 130		6.3	3	250	100	7.5	1.3	B8B	DDP
	7ED7	141 230 871 0000	00	141 230 651		7.3	1.9	200	175	10		B9A	P
	7EK7	148 235 118 0000	00	146 234 117		7	1.2	200		15	4	B9A	TT
	7ES8	841 238 510 0000	00	641 237 410		7	1.2	90		15	12.5	B9A	TT
	7EY6	028 740 310 0000	00	026 540 310		7.2	17.5	250	250	44	4.4	AO8	P
	7F7	218 548 130 0000	00	217 446 130		6.3	2	250		2.3	1.6	B8B	TT
	7F8	528 118 340 0000	00	427 116 340		6.3	3	250		6	3.3	B8B	TT
	7F16	281 174 130 0000	00	261 154 130		6.3	2.5	250	100	6	2.2	B8A	P
	7FC7	148 235 118 0000	00	146 234 117		7.2	1.2	90		15	12	B9A	TT
	7G7	287 114 130 0000	00	265 114 130		6.3	2	250	100	6	4.5	B8B	P
	7G8	287 451 830 0000	00	265 441 730		6.3	2.5	250	100	4.5	2.1	B8B	PP
	7GH8	788 234 151 0000	00	576 234 141		8	3	100		14		B9A	TH
	7GH8	788 234 151 0000	00	576 234 141		8	1.2	200	150	10		B9A	TH
	7GV7	878 231 514 0000	00	657 231 414		7.4	3	100		14	5.5		TP
	7GV7	878 231 514 0000	00	657 231 414		7.4	2	250	250	10	11		-
	7H6	287 114 130 0000	00	265 114 130		6.3	2.5	250	150	9.5	3.5	B8B	P
	7H7	287 114 130 0000	00	265 114 130		6.3	2	250	150	10	4.2	B8B	P
	7HG8	151 234 887 0000	00	741 234 675		7.2		125		15		B9A	TH
	7HG8	151 234 887 0000	00	741 234 675		7.2		250	150	18		B9A	TH
	7J7	208 405 130 0000	00	276 454 130		6.3	3	150		6.6	1.4	B8B	TH
	7J7	280 575 130 0000	00	276 454 130		6.3	3	250	100	1.4		B8B	TH
	7K7	218 4X9 130 0000	00	216 498 130		6.3	2	250		2.3	1.6	B8B	DDT
	7KY6	141 230 871 0000	00	141 230 651		7.3	0	200	135	30	30	B9A	P
	7KZ6	141 230 871 0000	00	141 230 651		7.3	0	250	115	25	24	B9A	P
	7L7	287 104 130 0000	00	265 104 130		6.3	1.5	250	100	4.5	3.1	B8B	P
	7MP18	412 387 400 0000	00	412 365 400		7.5	5	200	175	35	11	B9A	P
	7N7	218 548 130 0000	00	217 446 130		6.3	8	250		9	2.6	B8B	TT
	7Q7	288 414 130 0000	00	266 414 130		6.3	2	100		15	6	B8B	H
	7R1	290 300 000 0000	00	280 300 000		7.5				60		UX4	R
	7R7	28X 974 130 0000	00	269 854 130		6.3	1	250	100	6.2	3.4	B8B	DDP

SPEC.	VALVE TYPE NUMBER	PIN CONNECTIONS				CHARACTERISTICS						BASE	VALVE CLASS
		VCM163 Tester Only		CT160, VT160, VCM Mk 1,2,3,4		Vh	Vg1	Va	Vg2	la	gm mA/V		
		SELECTOR SWITCH	TOP CAP	SELECTOR SWITCH	TOP CAP	V	V	V	V	mA	†Ra MΩ		
	7S7	288 405 130 0000	00	276 454 130		6.3	1	100		4.8	1.4	B8B	TH
	7S7	280 575 130 0000	00	276 454 130		6.3	2	250	100	4	2	B8B	TH
	7T7	287 104 130 0000	00	265 104 130		6.3	1	250	150	10.8	4.9	B8B	P
	7V7	287 114 130 0000	00	265 114 130		6.3	2	300	150	10	5.8	B8B	P
	7X6	219 00X 130 0000	00	218 009 130		6.3				30		B8B	RR
	7X7	284 19X 130 0000	00	264 189 130		6.3	1	250		1.9	1.5	B8B	DDT
	7Y4	209 00X 130 0000	00	208 009 130		6.3				30		B8B	RR
	7Z4	20X 009 130 0000	00	209 008 130		6.3				60		B8B	RR
	8A1	742 310 000 0000	80	542 310 000	A1	4	1.5	200	75	3.5	4	B5	P
	8A1	041 231 700 0000	80	041 231 500	A1	4	1.5	200	75	3.5	4	B7	P
	8A2	742 310 000 0000	80	542 310 000	A1	4	2.1	200	100	3	2.4	B5	P
	8A8	857 238 114 0000	00	645 237 114		9	2	100		14	5	B9A	TP
	8A8	857 238 114 0000	00	645 237 114		9	2	200	175	10	6.2	B9A	TP
	8AC9	2X1 100 114 7830	00	-		8.4	1	125	125	12	10	A12	DDP
	8AU8	148 231 578 0000	00	146 231 457		8.5	1.25	150		8.5	4.9	B9A	TP
	8AU8	148 231 578 0000	00	146 231 457		8.5	1.5	200	125	16	7	B9A	TP
	8AW8	148 231 578 0000	00	146 231 457		8.4	2	200		4	4	B9A	TP
	8AW8	148 231 578 0000	00	146 231 457		8.4	3	200	150	13	9	B9A	TP
	8AW8A	000 231 478 0000	00	000 231 456		8.4	-2	200		4	4	B9A	TP
	8AW8A	000 231 478 0000	00	000 231 456		8.4	0	65	150	46	9.5	B9A	TP
	8AW8A	000 231 478 0000	00	000 231 456		8.4		150	150	15		B9A	TP
	8B8	415 238 718 0000	00	414 237 516		8	1	100		1	1.9	B9A	TP
	8B8	415 238 718 0000	00	414 237 516		8	16	200	200	35	6.4	B9A	TP
	8B10	215 848 1X1 9030	00	-		8.5	9.5	250		7	1.8	A12	DDT
	6BA8	148 231 578 0000	00	146 231 457		8.4	8	200		8	2.7	B9A	TP
	6BA8	148 231 578 0000	00	146 231 457		8.4	3	200	150	13	9	B9A	TP
	8BH8	148 231 578 0000	00	146 231 457		8.4	5	150		9.5	3.3	B9A	TP
	8BH8	148 231 578 0000	00	146 231 457		8.4	1.6	200	125	15	7	B9A	TP
	8BM8	415 238 718 0000	00	414 237 516		7.9	1	200		3.7	2.5	B9A	TP
	8BM8	415 238 718 0000	00	414 237 516		7.9	16	200	200	35	6.4	B9A	TP
	8BM11	287 015 871 4300	00	265 015 651		6.3	1	100	125	14	8	A12	PP
	8BM11	287 015 871 4300	00	265 015 651		6.3	0.9	150	125	12	9.8	A12	PP
	8BN8	911 23X 841 0000	00	811 239 641		8.4	3	250		1.6	2.6	B9A	DDT
	8BQ5	041 230 807 0000	00	*41 23* 6*5		8	7.3	250	250	48	11.5	B9A	P
	8BQ7A	841 238 510 0000	00	641 237 410		8.4	2	150		9	6.4	B9A	TT
	8BU11	218 415 867 8130	00	-		7.8	1	125		13.5	8.6	A12	TTP
	8BU11	218 415 867 8130	00	-		7.8	11	125	125	12	7.5	A12	TTP
	8CF40	857 238 114 0000	00	645 237 114		9	2	100		14	5	B9A	TP
	8CF40	857 238 114 0000	00	645 237 114		9	2	200	175	10	6.2	B9A	TP
	8CG7	851 238 410 0000	00	741 236 410		8.4	8	250		9	2.6	B9A	TT
	8CL8	841 235 178 0000	00	461 237 514		8.4	2	200		4	4	B9A	TP
	8CL8	841 235 178 0000	00	461 237 514		8.4	1.2	150	100	4	4.4	B9A	TP
	8CM7	801 238 451 0000	00	701 236 441		8.4	7	200		5	2	B9A	TT
	8CM7	801 238 451 0000	00	701 236 441		8.4	8	250		20	4.4	B9A	TT
	8CN7	9X1 221 843 0000	00	891 221 643		4.2	3	250		1	1.2	B9A	DDT
	8CS7	805 238 411 0000	00	704 236 411		8.4	10.6	250		19	4.5	B9A	TT
	8CW5	071 230 807 0000	00	*51 23* 6*5		8	12.5	200	175	70	10	B9A	P
	8CW8	517 238 148 0000	00	415 237 146		8	1.7	250		1.2	1.6	B9A	TP
	8CW8	517 238 148 0000	00	415 237 146		8	7	250	250	36	10	B9A	TP
	8CX8	148 231 478 0000	00	146 231 456		8	1.5	150		9	4.6	B9A	TP
	8CX8	148 231 478 0000	00	146 231 456		8	2	200	125	25	10	B9A	TP
	8CY7	805 238 411 0000	00	6*4 237 411		7.9	3	250		1.2	1.3	B9A	TT
	8CY7	805 238 411 0000	00	6*4 237 411		7.9	18.5	150		30	5.4	B9A	TT

SPEC.	VALVE TYPE NUMBER	PIN CONNECTIONS				CHARACTERISTICS						BASE	VALVE CLASS
		VCM163 Tester Only		CT160, VT160, VCM Mk 1,2,3,4		Vh	Vg1	Va	Vg2	Ia	gm mA/V		
		SELECTOR SWITCH	TOP CAP	SELECTOR SWITCH	TOP CAP	V	V	V	V	mA	†Ra MΩ		
	8D2	081 231 700 0000	40	061 231 500	G1	13	3	250	100	2	1.25	B7	P
	8D3	412 381 700 0000	00	412 361 500		6.3	2	250	250	10	7.5	B7G	P
	8D3	412 381 700 0000	00	412 361 500		6.3	1.5	200	150	4	6.4	B7G	P
	8D4	028 710 310 0000	40	026 510 310	G1	6.3	2	250	100	3	1.8	AO8	P
	8D5	041 230 871 0000	00	041 230 651		6.3	3	250	100	2	1.2	B9A	P
	8D6	141 230 871 0000	00	141 230 651		6.3	2	200	175	10	2.5	B9A	P
	8D7	001 230 871 0000	40	001 230 651	G1	6.3	3	250	100	2	1.25	B9A	P
	8D8	701 238 014 0000	00	501 236 014		6.3	2	250	150	3	1.9	B9A	P
	8DX8	481 238 157 0000	00	461 237 145		7.5	1.7	200		30	4	B9A	TP
	8DX8	481 238 157 0000	00	461 237 145		7.5	2.1	200	175	18	11	B9A	TP
	8EB8	148 231 578 0000	00	146 231 457		8	2	250		2	2.7	B9A	TP
	8EB8	148 231 578 0000	00	146 231 457		8	2	200	125	25	12.5	B9A	TP
	8EM5	704 234 108 0000	00	504 234 106		8.4	18	250	250	35	5.1	B9A	P
	8ET7	19X 231 478 0000	00	189 231 456		8	100	200	150	25	11.5	B9A	DDP
	8FQ7	851 238 410 0000	00	741 236 410		8.4	8	250		9	2.6	B9A	TT
	8G140	9X2 300 000 0000	00	892 300 000		8				60		B4	RR
	8GE8	148 231 578 0000	00	146 231 457		8.2	2	200		4.5	4.2	B9A	TP
	8GE8	148 231 578 0000	00	146 231 457		8.2		200	175	22	12	B9A	TP
	8GK6	141 230 871 0000	00	141 230 651		8	7.4	250	250	48	11.3	B9A	P
	8GN8	148 231 578 0000	00	146 231 457		8	2	250		2	2.7	B9A	TP
	8GN8	148 231 578 0000	00	146 231 457		8	3	200	150	25	11.5	B9A	TP
	8GW8	417 238 158 0000	00	415 237 146		7.5	1.7	250		1.2	1.6	B9A	TP
	8GW8	417 238 158 0000	00	415 237 146		7.5	7.0	250	250	36	10	B9A	TP
	8GX7	151 238 784 0000	00	151 236 574		7.7	1	125		13	8.5	B9A	TP
	8GX7	151 238 784 0000	00	151 236 574		7.7	1	125	125	8	11	B9A	TP
	8HG8	151 234 887 0000	00	141 234 675		8	3	100		14	5.5	B9A	TP
	8HG8	151 234 887 0000	00	141 234 675		8	1.2	200	150	10	12	B9A	TP
	8JE8	148 231 578 0000	00	146 231 457		8.2	2	200		4.5	4.2	B9A	TP
	8JE8	148 231 578 0000	00	146 231 457		8.2		250	150	22	12	B9A	TP
	8JK8	841 238 510 0000	00	741 236 410		8.4	1.0	100		5.3	6.8	B9A	TT
	8JK8	841 238 510 0000	00	741 236 410		8.4	1.2	150		10	13	B9A	TT
	8JT8	148 231 578 0000	00	146 231 457		7.7	2	250		1.5	2.7	B9A	TP
	8JT8	148 231 578 0000	00	146 231 457		7.7	1.6	200	100	17	20	B9A	TP
	8JV8	148 231 578 0000	00	146 231 457		8.5	2	200		4	4	B9A	TP
	8JV8	148 231 578 0000	00	146 231 457		8.5	2.9	200	200	22	10.7	B9A	TP
	8KA8	841 235 178 0000	00	641 234 157		8.4	2	200		4	4	B9A	TP
	8KA8	841 235 178 0000	00	641 234 157		8.4	1.2	150	100	4	4.4	B9A	TP
	8LC8	841 235 178 0000	00	641 234 157		8.4	2	200		4	4	B9A	TP
	8LC8	841 235 178 0000	00	641 234 157		8.4	1.2	150	100	4	9.4	B9A	TP
	8LE8	811 230 174 0000	00	611 230 154		8	2.5	100	100	8	5.8	B9A	PP
	8LE8	011 238 174 0000	00	611 230 154		8	2.5	100	100	8	5.8	B9A	PP
	8MP12	412 387 400 0000	00	412 365 400		8.5		200	175	25		B7G	P
	8RB11	704 234 108 0000	00	504 234 106		8.5	12.5	200	200	45	7.5	B9A	P
	8RHP1	415 238 718 0000	00	414 237 516		8.2		100		3.5	2.5	B9A	TP
	8RHP1	415 238 718 0000	00	414 237 516		8.2	16	200	200	35	6.4	B9A	TP
	8SN7	481 581 230 0000	00	461 471 230		8.4	8	250		9	2.6	AO8	TT
	8T27	841 238 510 0000	00	641 237 410		8.4		150		10	6.8	B9A	TT
	9A1	742 231 000 0000	80	542 231 000	A1	4	1.5	200	75	5	4.2	B5	P
	9A1	947 231 700 0000	80	045 231 500	A1	4	1.5	200	75	5	4.2	B7	P
	9A3	081 231 700 0000	40	061 231 500	G1	4	2	250	125	10	1.8	B7	P
	9A8	857 238 114 0000	00	645 237 114		9	2	100		14	5	B9A	TP
	9A8	857 238 114 0000	00	645 237 114		9	2	200	175	10	6.2	B9A	TP
	9AB4	802 304 100 0000	00	602 304 100		9	2	250		10	5	B7G	T

SPEC.	VALVE TYPE NUMBER	PIN CONNECTIONS				CHARACTERISTICS						BASE	VALVE CLASS
		VCM163 Tester Only		CT160, VT160, VCM Mk 1,2,3,4		Vh	Vg1	Va	Vg2	la	gm mA/V		
		SELECTOR SWITCH	TOP CAP	SELECTOR SWITCH	TOP CAP	V	V	V	V	mA	†Ra MΩ		
	9ABC40	9X1 23Y 148 0000	00	891 230 146		9.5	1.9	170		1	1.4	B9A	DDDT
	9AK8	YX1 239 148 0000	00	†91 238 146		9.5	2.3	200		1	1.4	B9A	DDDT
	9AQ8	841 238 510 0000	00	641 237 410		9	2.1	200		10	5.8	B9A	TT
	9AU7	851 228 413 0000	00	741 226 413		4.7	3.5	250		10.5	2.2	B9A	TT
	9BM5	412 387 400 0000	00	412 365 400		9	6	250	250	30	7	B9A	P
	9BQ7	841 238 510 0000	00	641 237 410		8.4	2	150		9	6.4	B9A	TT
	9BR7	841 22X 913 0000	00	641 229 813		4.7	2.0	250		10	4	B9A	DDT
	9BW6	041 230 871 0000	00	*41 230 651		9	12.5	250	250	45	4.1	B9A	P
	9C8	857 238 114 0000	00	645 237 114		9	2	100		14	5	B9A	TP
	9C8	857 238 114 0000	00	645 237 114		9	2	200	175	10	6.2	B9A	TP
	9CL8	481 238 715 0000	00	461 237 514		9.5	0.75	150		15	8	B9A	TP
	9CL8	481 238 715 0000	00	461 237 514		9.5	0.1	150	125	12	5.8	B9A	TP
	9D2	081 231 700 0000	40	061 231 500	G1	13	3	250	125	10.5	1.65	B7	P
	9D6	412 381 700 0000	00	412 361 500		6.3	2.5	250	200	8	2.5	B7G	P
	9D7	141 230 871 0000	00	141 230 651		6.3	1.5	250	100	10	8.4	B9A	P
	9DZ8	415 238 718 0000	00	414 237 516		9	1.2	150		0.8	1.4	B9A	TP
	9DZ8	415 238 718 0000	00	414 237 516		9	8	150	125	45	7.5	B9A	TP
	9EA8	857 238 114 0000	00	857 238 114		18.9	1	150		18	8.5	B9A	TP
	9EA8	857 238 114 0000	00	857 238 114		18.9	1	125	125	12	6.4	B9A	TP
	9EF6	028 740 310 0000	00	026 540 310		9.4	18	250	250	50	5	AO8	P
	9EN7	157 238 414 0000	00	157 236 414		9		150		6	5	B9A	TP
	9EN7	157 238 414 0000	00	157 236 414		9		200	150	7.6	8.5	B9A	TP
	9GV8	841 238 741 0000	00	641 237 541		9.4	.8	250		8		B9A	TP
	9GV8	841 238 741 0000	00	641 237 541		9.4	15	250	250	12		B9A	TP
	9J6	882 345 100 0000	00	762 344 100		9	0.85	100		8.5	5.3	B7G	TT
	9JT8	148 231 778 0000	00	148 231 578		7.7	2	250		1.5	2.7	B9A	TP
	9JT8	148 231 778 0000	00	148 231 578		7.7	1.6	200	100	1.7	20	B9A	TP
	9KC6	140 231 807 0000	00	140 231 605		8.7	1	250	150	18.0	24	B9A	P
	9KZ8	851 238 715 0000	00	641 237 514		9.4	1	125		13.5	8.5	B9A	TP
	9KZ8	851 238 715 0000	00	641 237 514		9.4	1	125	125	12	7.5	B9A	TP
	9LA6	147 230 856 0000	00	145 230 644		8.7	0	250	150	25	21.0	B9A	P
	9MN8	2Y1 X09 040 5630	00	-		9.5	0	200		4.8	4.0	B9A	TTT
	9MN8	2Y1 X09 040 5630	00	-		9.5	0	125		11.0	7.5	B9A	TTT
	9P9	412 387 400 0000	00	412 365 400		9	6	250	250	30	7	B9A	P
	9RA6	140 230 408 0000	00	140 230 406		9.5	12	250		26	8.5	B9A	T
	9T8	YX1 239 148 0000	00	†91 238 146		9.5	3	250		1	1.2	B9A	DDDT
	9T26	841 238 510 0000	00	641 237 410		9.5	2.3	250		10	6	B9A	TT
	9TP4	157 238 814 0000	00	145 237 614		9.4		150		18	8.5	B9A	TP
	9TP4	157 238 814 0000	00	145 237 614		9.4	68	250	100	10	5.2	B9A	TP
	9U8	857 238 114 0000	00	645 237 114		9.5	1	150		18	8.5	B9A	TP
	9U8	857 238 114 0000	00	645 237 114		9.5	1	250	100	10	5.2	B9A	TP
	9X8	148 231 578 0000	00	146 231 457		9.5		100		8.5	5.8	B9A	TP
	9X8	148 231 578 0000	00	146 231 457		9.5	3.5	150	150	6.2	2.1	B9A	TP
	10	284 300 000 0000	00	264 300 000		7.5	32	250		16	1.55	UX4	T
	10AL11	215 118 741 7830	00	-		9.8	2	15	100	1.3	1	A12	PP
	10BM8	415 238 718 0000	00	414 237 516		10		100		3	2.2	B9A	TP
	10BM8	415 238 718 0000	00	414 237 516		10	11.5	150	150	41	7.5	B9A	TP
	10BQ5	041 230 807 0000	00	041 230 605		10	7.3	250	250	48	11	B9A	P
	10C1	208 475 130 0000	00	276 454 130		28	3.3	100		6	3	B9A	TH
	10C1	280 575 130 0000	00	276 454 130		28	2.5	200	100	8	2.5	B9A	TH
	10C2	288 475 130 0000	00	276 454 130		28	3.3	100		6	3	B8A	TP
	10C2	288 475 130 0000	00	276 454 130		28	1.5	175	100	3	5	B8A	TP

SPEC.	VALVE TYPE NUMBER	PIN CONNECTIONS				CHARACTERISTICS						BASE	VALVE CLASS
		VCM163 Tester Only		CT160, VT160, VCM Mk 1,2,3,4		Vh	Vg1	Va	Vg2	la	gm mA/V		
		SELECTOR SWITCH	TOP CAP	SELECTOR SWITCH	TOP CAP	V	V	V	V	mA	†Ra MΩ		
	10C8	841 238 751 0000	00	641 237 541		10.5	2.7	250		7.3	4.4	B9A	TP
	10C8	841 238 751 0000	00	641 237 541		10.5	1.5	150	125	11.5	8	B9A	TP
	10C14	751 238 184 0000	00	541 237 164		19		100		13.7	3.7	B9A	TP
	10C14	751 238 184 0000	00	541 237 164		19	2.2	200	100	5	2.3	B9A	TP
	10CW5	041 230 807 0000	00	*41 23* 6*5		10	12.5	150	150	70	10	B9A	P
	10D1	9X2 310 000 0000	00	892 310 000		13				5		B5	RR
	10D2	1X2 310 900 0000	00	192 310 800		19				5		B7G	RR
	10DA7	814 238 511 0000	00	614 237 411		10.5	8	250		9	2.6	B9G	TT
	10DA7	814 238 511 0000	00	614 237 411		10.5	17.5	150		40	5.7	B9G	TT
	10DA8	804 238 511 0000	00	604 237 411		10.5	8	250		9	2.6	B9A	TT
	10DE7	855 238 411 0000	00	744 236 411		10	17.5	150		32	6.5	B9A	TT
	10DE7	855 238 411 0000	00	744 236 411		10	11	250		5.5	2	B9A	TT
	10DR7	855 238 411 0000	00	744 236 411		9.7	17.5	150		35	6.5	B9A	TT
	10DR7	855 238 411 0000	00	744 236 411		9.7	3	250		1.4	1.6	B9A	TT
	10DX8	481 238 157 0000	00	461 237 145		10	1.7	200		3	4	B9A	TP
	10DX8	481 238 157 0000	00	461 237 145		10	2.1	200	175	18	11	B9A	TP
	10EB8	148 231 578 0000	00	146 231 457		10.5	2	250		2	2.7	B9A	TP
	10EB8	148 231 578 0000	00	146 231 457		10.5		200	125	25	12.5	B9A	TP
	10EG7	581 481 230 0000	00	471 461 230		9.7	11	350		5.5	2	AO8	TT
	10EG7	581 481 230 0000	00	471 461 230		9.7	17.5	150		45	7.5	AO8	TT
	10EM7	581 481 230 0000	00	461 471 230		9.7	20	150		50	7.2	B9A	TT
	10EM7	581 481 230 0000	00	461 471 230		9.7	3	250		1.4	1.6	B9A	TT
	10ER5	142 380 100 0000	00	142 360 100		10.8	1.2	200		10	10.5	B7G	TT
	10EW7	855 238 411 0000	00	744 236 411		9.7	17.5	150		45	7.5	B9A	TT
	10EW7	855 238 411 0000	00	744 236 411		9.7	11	250		5.5	2.0	B9A	TT
	10F1	281 714 130 0000	00	261 415 130		22	1.8	200	200	100	9	B8A	P
	10F3	280 174 130 0000	00	260 154 130		22	2.3	200	200	6	6.5	B8A	P
	10F9	280 174 130 0000	00	260 154 130		13	2.5	200	100	7	2.3	B8A	P
	10F18	141 230 871 0000	00	141 230 651		13	1.3	200	100	12	4.5	B9A	P
	10FD7	855 238 411 0000	00	644 237 411		9.7		250		6	1.6	B9A	TT
	10FD7	855 238 411 0000	00	644 237 411		9.7	17.5	150		45	7.5	B9A	TT
	10FD12	741 238 9X1 0000	00	541 236 891		19	1.5	200	200	11	4.5	B9A	DDP
	10FG7	151 238 084 0000	00	141 237 064		9.7	3	250		1.4	1.6	B9A	TT
	10FG7	151 238 084 0000	00	141 237 064		9.7	20	150		50	7.2	B9A	TT
	10FR7	844 238 511 0000	00	644 237 411		9.7	3	250		1.4	1.6	B9A	TT
	10FR7	844 238 511 0000	00	644 237 411		9.7	20	150		50	7.2	B9A	TT
	10GF7	151 238 084 0000	00	141 237 064		9.7	20	150		50	7.2	B9D	TT
	10GF7	151 238 084 0000	00	141 237 064		9.7	3	250		1.4	1.6	B9D	TT
	10GF7A	151 238 084 0000	00	151 236 094		9.7	-3	250		1.4		B9A	TT
	10GF7A	151 238 084 0000	00	151 236 094		9.7	0	60		95		B9A	TT
	10GF7A	151 238 084 0000	00	151 236 094		9.7	-20	150		50		B9A	TT
	10GF7A	151 238 084 0000	00	151 236 094		9.7	28	250		10		B9A	TT
	10GN8	148 231 578 0000	00	146 231 457		10.5	2	250		2	2.7	B9A	TP
	10GN8	148 231 578 0000	00	146 231 457		10.5	3	200	150	25	11.5	B9A	TP
	10GW8	417 238 158 0000	00	415 237 146		10	1.7	250		1.2	1.6	B9A	TP
	10GW8	417 238 158 0000	00	415 237 146		10	7	250	250	36	10	B9A	TP
	10FH8	148 231 578 0000	00	146 231 457		10	2	250		4	4	B9A	TP
	10FH8	148 231 578 0000	00	146 231 457		10	1	250	250	25	12.5	B9A	TP
	10JA8	148 231 578 0000	00	146 231 457		10.5	2	150		1	1.5	B9A	TP
	10JA8	148 231 578 0000	00	146 231 457		10.5	1.5	150	150	18	13	B9A	TP
	10JT8	148 231 578 0000	00	148 231 578		10.2	2	250		1.5	2.7	B9A	TP
	10JT8	148 231 578 0000	00	148 231 578		10.2	1.6	200	100	17	20	B9A	TP
	10JY8	148 231 578 0000	00	146 231 457		10.5		125		15	10.4	B9A	TP
	10JY8	148 231 578 0000	00	146 231 457		10.5		200	150	24	11	B9A	TP



SPEC.	VALVE TYPE NUMBER	PIN CONNECTIONS				CHARACTERISTICS						BASE	VALVE CLASS
		VCM163 Tester Only		CT160, VT160, VCM Mk 1,2,3,4		Vh	Vg1	Va	Vg2	la	gm mA/V		
		SELECTOR SWITCH	TOP CAP	SELECTOR SWITCH	TOP CAP	V	V	V	V	mA	†Ra MΩ		
	10KR8	148 231 578 0000	00	146 231 457		10.5	1	100		15	10.4	B9A	TP
	10KR8	148 231 578 0000	00	146 231 457		10.5	1.6	200	100	19.5	20.0	B9A	TP
	10KU8	19X 231 478 0000	00	19* 231 478		10.2	1.6	200	100	17	20	B9A	DDP
	10L1	412 314 800 0000	00	412 314 600		19	1.5	250		10	8.5	B7G	T
	10L14	841 238 510 0000	00	641 237 410		26	2.1	200		10	5.8	B9A	TT
	10L88	148 231 578 0000	00	148 231 578		10.2	0.9	125		13	5	B9A	TP
	10LB8	148 231 578 0000	00	148 231 578		10.2	1.6	200	100	17	20	B9A	TP
	10LD3	284 0X9 130 0000	00	264 098 130		14	1.1	150		0.6	1.95	B8A	DDT
	10LD11	284 0X9 130 0000	00	264 098 130		15	5.9	250		5	2.3	B8A	DDT
	10LD12	YX1 239 148 0000	00	†91 238 146		28	2.3	200		1	1.4	B9A	DDDT
	10LD13	841 239 0X0 0000	00	641 238 09*		13	4.4	150		0.5	1.4	B9A	DDT
	10LE8	811 230 174 0000	00	011 236 154		10	2.5	100	100	8	5.8	B9A	PP
	10LE8	011 238 174 0000	00	011 236 154		10	2.5	100	100	8	5.8	B9A	PP
	10M1	028 740 310 0000	00	026 540 310		18	19	200	175	0.2	†1.0	AO8	TI
	10M2	208 478 130 0000	00	206 456 130		12.6	3	200	200	0.1	†0.2	AO8	TI
	10M2	208 478 130 0000	00	206 456 130		12.6	20	200	200	0.19	†0.1	AO8	TI
	10P13	280 074 130 0000	00	260 054 130		40	6	150	150	30	7.5	B8A	P
	10P14	028 740 310 0000	00	026 540 310		40	9.4	200	175	40	7.2	AO8	P
	10P18	041 230 807 0000	00	*41 23* 6*5		45	12.5	200	175	70	10	B9A	P
	10PL12	415 238 718 0000	00	414 237 516		50		100		3.5	2.5	B9A	TP
	10PL12	415 238 718 0000	00	414 237 516		50	16	200	200	35	6.4	B9A	TP
	11	382 400 000 0000	00	362 400 000		1.1	4.5	90		2.5	0.4	UX4	T
	11A1	010 234 008 0000	00	*1* 234 **6		6.3		150		100	12	B9A	T
	11A2	X09 231 800 0000	40	908 231 600	G1	4	2	200		3	2.8	B7	DDT
	11A6	284 158 300 0000	00	264 147 300		10	1	100			3.1	AO8	TT
	11AR11	287 151 187 4130	00	-		11.2	0.7	125	125	11	10.5	A12	PP
	11C5	028 040 310 0000	00	026 040 310		10	1	100			2	AO8	T
	11CY7	805 238 411 0000	00	7*4 236 411		11	3	250		1.2	1.3	B9A	TT
	11CY7	805 238 411 0000	00	7*4 236 411		11		150		30	5.4	B9A	TT
	11D3	X09 231 800 0000	40	908 231 600	G1	13	2	250		0.6	1.1	B7	DDT
	11D5	X09 231 800 0000	40	908 231 600	G1	13	3	250		3.8	1.5	B7	DDT
	11E1	218 740 030 0000	00	216 540 030		63		250	250	50	7.3	M08	P
	11E2	020 740 310 0000	80	020 540 310	A1	6.3	16.5	200	200	25	9	AO8	P
	11E8	200 848 310 0000	50	200 647 310	G1	11		150		20		AO8	TT
	11E13	415 228 783 0000	00	414 226 573		6.3	40	300	200	75		B9A	PP
	11E14	020 740 310 0000	80	020 540 310	A1	6.3	16	250	250	48	7	AO8	P
	11F6	028 740 310 0000	00	026 540 310		10	1	100	150		2.5	AO8	P
	11HM7	141 230 871 0000	00	141 230 651		11.0	0	250	135	30	30.0	B9A	P
	11J7	028 700 310 0000	40	026 500 310	G1	10	1	250	100		1.2	AO8	P
	11JE8	148 231 578 0000	00	146 231 457		10	2	200		4.5	4.2	B9A	TP
	11JE8	148 231 578 0000	00	146 231 457		10		200	175	22	12	B9A	TP
	11K7	028 700 310 0000	40	026 500 310	G1	10	1	250	100		1.4	AO8	P
	11KV8	148 231 578 0000	00	146 231 457		10.9	1.8	200		4	4	B9A	TP
	11KV8	148 231 578 0000	00	146 231 457		10.9	1.6	200	125	20	23	B9A	TP
	11L6	028 740 310 0000	00	026 540 310		10	1	100	150		6	AO8	P
	11LQ8	148 231 578 0000	00	146 231 456		10.9	1	125		15	10.4	B9A	TP
	11LQ8	148 231 578 0000	00	146 231 456		10.9	1.6	125	125	16.5	21	B9A	TP
	11N7	028 458 310 0000	00	026 447 310		10	1	100			3.1	AO8	TT
	11QL8	148 231 578 0000	00	146 231 457		10.9	1	125		15	10.4	B9A	TP
	11QL8	148 231 578 0000	00	146 231 457		10.9	1.4	200	125	20	23	B9A	TP
	11X5	029 0X0 310 0000	00	028 090 310		11				30		AO8	RR
	12	384 200 000 0000	00	364 200 000		1.1	4.5	90		2.5	0.42	UX4	T
	12A	284 300 000 0000	00	264 300 000		5	4.5	90		5	1.5	UX4	T

SPEC.	VALVE TYPE NUMBER	PIN CONNECTIONS				CHARACTERISTICS						BASE	VALVE CLASS
		VCM163 Tester Only		CT160, VT160, VCM Mk 1,2,3,4		Vh	Vg1	Va	Vg2	la	gm mA/V		
		SELECTOR SWITCH	TOP CAP	SELECTOR SWITCH	TOP CAP	V	V	V	V	mA	†Ra MΩ		
	12A4	142 330 408 0000	00	142 330 406		6.3	9	250		23	0.8	B9A	T
	12A5	287 413 200 0000	00	265 413 200		6.3	15	100	100	17	1.7	UX7	P
	12A6	028 740 310 0000	00	026 540 310		12.5	12.5	250	250	30	2	AO8	P
	12A7	287 191 300 0000	40	265 181 300	G1	12.5				30		Sm7	RP
	12A7	287 191 300 0000	40	265 181 300	G1	12.5	12.5	150	150	9	1	Sm7	RP
	12A8	028 747 310 0000	40	026 545 310	G1	12.5	3	250	100	3.5	1.15	AO8	H
	12AB5	704 234 178 0000	00	504 234 156		12	12.5	250	250	45	4.1	B9A	P
	12AB5	421 080 370 0000	00	421 060 350		12	22.5	250	150	57	5.9	AO8	P
	12AC5	280 074 130 0000	00	26* *54 130		12	3	200	125	2.3	2.3	B8A	P
	12AC6	412 387 100 0000	00	412 365 100		12.6	10	12.6	12.6	0.5	0.7	B7G	P
	12AD5	741 238 000 0000	00	541 236 **0		12.6	2.5	100	100	6	2.2	B9A	P
	12AD6	412 387 100 0000	00	412 365 100		12.6		12	12	5	3.8	B7G	P
	12AD7	841 228 513 0000	00	641 227 413		6.3	2	250		1.25	1.6	B9A	TT
	12AE6	412 39X 800 0000	00	412 389 600		12.6	0	12.6		0.7	1	B7G	DDT
	12AE7	841 228 513 0000	00	641 227 413		6.3		12.6		0.9	6.5	B9A	TT
	12AF3	000 230 990 0000	00	*** 23* 88*		12.6				120		B9A	R
	12AF6	412 387 100 0000	00	412 365 100		12.6		12	12	0.7	1.1	B7G	P
	12AG6	412 387 100 0000	00	412 365 100		12.6	0.8	12	12	0.5		B7G	H
	12AH6	412 389 100 0000	00	412 365 100		12.6	2	300	150	10	9	B7G	P
	12AH7	418 158 230 0000	00	417 146 230		12.5	3.6	100		3.7	1.55	AO8	TT
	12AH8	051 220 483 0000	00	541 227 463		6.3		100		14.7	3.5	B9A	TH
	12AH8	751 228 503 0000	00	541 227 463		6.3	3	250	100	2.6		B9A	TH
	12AJ6	412 39X 800 0000	00	412 389 600		12.6		12		0.7	1.2	B7G	DDT
	12AJ7	741 238 484 0000	00	541 237 464		12		100		4	2	B9A	TH
	12AJ7	741 238 484 0000	00	541 237 464		12	2.5	250	90	3	0.6	B9A	TH
	12AK7	851 228 413 0000	00	741 226 413		6.3		250		1.2	1.6	B9A	TT
	12AL5	1X2 310 900 0000	00	192 310 800		12.5				5		B7G	RR
	12AL8	875 238 141 0000	00	654 237 141		12.6	0.9	12		0.2	0.5	B9A	TP
	12AL8	875 238 141 0000	00	654 237 141		12.6	0.8	12	12	25	8	B9A	TP
	12AL11	215 118 741 7830	00	-		12.6	8	250	250	36	6.5	A12	PP
	12AQ5	412 387 400 0000	00	412 365 400		12.5	12.5	250	250	45	4.1	B7G	P
	12AS5	142 347 800 0000	00	142 345 600		12	8.5	150	100	35	5.6	B7G	P
	12AT6	412 39X 800 0000	00	412 389 600		6.3	3	250		1	1.2	B7G	DDT
	12AT7	851 228 413 0000	00	741 226 413		6.3	2	250		10	5.5	B9A	TT
	12AU4	001 090 230 0000	00	001 080 230		12				120		AO8	R
	12AU6	412 387 100 0000	00	412 365 100		12.6	1	250	150	10.8	5.2	B7G	P
	12AU7	851 228 413 0000	00	741 226 413		6.3	8.5	250		10.5	2.2	B9A	TT
	12AU8	148 231 578 0000	00	146 231 457		12.6	1.5	150		8.5	4.9	B9A	TP
	12AU8	148 231 578 0000	00	146 231 457		12.6	1.35	200	125	15	7	B9A	TP
	12AV5	421 080 370 0000	00	421 060 350		12.6	22.5	250	150	55	5.5	AO8	P
	12AV6	412 39X 800 0000	00	412 389 600		12.5	2	250		1.2	1.6	B7G	DDT
	12AV7	851 228 413 0000	00	741 226 413		6.3	1	150		18	8.5	B9A	TT
	12VA7A	X51 239 413 0000	00	961 238 413		12.6	0	100		3.1	6.25	B9A	TT
	12AW6	412 387 100 0000	00	412 365 100		12.5	1.5	250	150	7	5	B7G	P
	12AX4	001 090 230 0000	00	001 080 230		12.5				120		AO8	R
	12AX7A	841 228 410 0000	00	741 237 410		6.3	2	250		1.2	1.6	B9A	TT
	12AY3	090 230 901 0000	00	080 230 801		12.6				180		B9D	R
	12AY3A	080 230 801 0000	00	080 230 801		12.6		32		350		B9A	R
	12AY7	841 228 513 0000	00	641 227 413		6.3	4	250		3	1.7	B9A	TT
	12AZ7	851 228 413 0000	00	741 226 413		6.3	2	200		10	5.5	B9A	TT
	12AZ7A	X71 239 410 0000	00	941 238 410		12.6	-5	100		3.7	4.0	B9A	TT
	12B3	090 230 909 0000	10	080 230 808	C1	12.6						B9A	R
	12B4	142 330 408 0000	00	142 330 406		6.3	17.5	150		34	6.4	B9A	T
	12B4A	140 230 408 0000	00	140 230 406		12.6	-17.5	150		34	6.3	B9A	T

SPEC.	VALVE TYPE NUMBER	PIN CONNECTIONS				CHARACTERISTICS						BASE	VALVE CLASS
		VCM163 Tester Only		CT160, VT160, VCM Mk 1,2,3,4		Vh	Vg1	Va	Vg2	la	gm mA/V		
		SELECTOR SWITCH	TOP CAP	SELECTOR SWITCH	TOP CAP	V	V	V	V	mA	†Ra MΩ		
	12B6	028 090 310 0000	40	026 080 310	G1	12.5	2	250		0.9	1.1	AO8	DT
	12B7	287 104 130 0000	00	265 104 130		12.5	3	250	100	9.2	2	B8B	P
	12B8	128 781 340 0000	50	127 561 340	G1	12.5	1.1	100		0.6	1.5	AO8	TP
	12B8	128 781 340 0000	50	127 561 340	G1	12.5	3	100	100	8	2.1	AO8	TP
	12BA6	412 387 100 0000	00	412 365 100		12.5	1	250	100	11	4.4	B7G	P
	12BA7	841 231 108 0000	00	641 231 106		12.5	2	100		18	7	B9A	H
	12BB14	441 237 710 0000	80	441 235 510	A1	12	20	150	150	70	10	B9D	P
	12BC32	412 39X 800 0000	00	412 389 600		12	2	250		1	1.6	B7G	DDT
	12BD6	412 387 100 0000	00	412 365 100		12.5	3	250	100	9	2	B7G	P
	12BE3	200 900 100 9030	00	-		12.6				120		A12	R
	12BE6	412 388 100 0000	00	412 366 100		12.5	6	150		7.5	3.5	B7G	H
	12BF6	412 3X9 800 0000	00	412 398 600		12.5	9	250		9.5	1.9	B7G	DDT
	12BF11	215 017 841 7830	00	214 015 641	A	12.6	6	150	100	3.8	8.6	A12	PP
	12BF11	215 017 841 7830	00	214 015 641	A	12.6	1.8	150	100	1.3	1	A12	PP
	12BH7	851 228 413 0000	00	741 226 413		6.3	10.5	250		11.5	3.1	B9A	TT
	12BH7A	851 238 410 0000	00	641 236 410		12.6	-10.5	250		11.5	3.1	B9A	TT
	12BK5	804 231 470 0000	00	604 231 450		12	5	250	250	35	8.5	B9A	P
	12BL6	412 387 100 0000	00	412 365 100		12.6	0.6	12	12	1.4	1.3	B7G	P
	12BN6	142 374 800 0000	00	142 354 600		12.5	1	60	60	0.5	1	B7G	P
	12BQ6	020 740 310 0000	80	020 540 310	A1	12	22.5	250	150	57	5.9	AO8	P
	12BR7	841 229 X13 0000	00	641 228 913		6.3	2	250		10	5.5	B9A	DDT
	12BR7A	841 229 X13 0000	00	641 228 913		6.3	2	250		10	5.5	B9A	DDT
	12BS3	090 230 901 0000	00	*8* 23* 8*1		12.6				180		B9D	R
	12BT6	412 39X 800 0000	00	412 389 600		12.5	3	250		1	1.2	B7G	DDT
	12BU6	412 39X 800 0000	00	412 389 600		12.5	9	250		9.5	1.9	B7G	DDT
	12BU8	178 231 481 0000	00	156 231 471		12.6	1	100	60	1	1.5	B7G	PP
	12BV7	141 223 871 0000	00	141 223 651		6.3	2.2	250	150	27	13	B9A	P
	12BW4	900 230 X01 0000	00	800 230 901		12				30		B9A	RR
	12BX6	141 230 871 0000	00	141 230 651		12.6	2	150	150	10	7.4	B9A	P
	12BY7	141 223 871 0000	00	141 223 651		6.3	2.1	250	150	25	12	B9A	P
	12BY7A	141 230 871 0000	00	141 230 651		12.6	3	250	175	26	11.0	B9A	P
	12BZ6	412 387 100 0000	00	412 365 100		12.6	1	100	125	14	8	B7G	P
	12BZ7	851 228 413 0000	00	741 226 413		6.3	2	250		2.5	3.2	B9A	TT
	12C2C	028 040 310 0000	00	026 040 310		12.6	8	250		9	2.6	AO8	T
	12C5	142 347 800 0000	00	142 345 600		12	7.5	150	100	49	7.5	B7G	P
	12C8	028 X97 310 0000	40	026 985 310	G1	12.5	3	250	125	10	1.3	AO8	DDP
	12CA5	142 347 800 0000	00	142 345 600		12	4.5	125	125	36	9.2	B7G	P
	12CD6	021 040 370 0000	80	021 040 350		12.6	55	150	150	75	7.7	AO8	P
	12CK3	080 230 801 0000	00	080 230 801		12.6				250		B9A	R
	12CL3	080 230 801 0000	00	080 230 801		12.6				350		B9A	R
	12CM6	704 234 108 0000	00	504 234 106		12	12.5	250	250	45	4.1	B9A	P
	12CN5	142 347 800 0000	00	142 345 600		12.6		12	12	4.5	3.8	B7G	P
	12CR5	174 231 741 0000	80	154 231 541	A1	12.6	22.5	250	150	65	6	B9A	P
	12CR6	192 387 400 0000	00	182 365 400		12	2	250	100	6.9	2.2	B7G	DP
	12CS5	714 234 108 0000	00	514 234 *1*6		12.6	10	200	125	47	8	B9A	P
	12CS6	112 387 400 0000	00	112 365 400		12	1	100	30	0.8	1.5	B7G	P
	12CT8	841 238 751 0000	00	641 237 541		12	1.4	150		9	4.9	B9A	TP
	12CT8	841 238 751 0000	00	641 237 541		12	1.5	200	125	15	7	B9A	TP
	12CU5	142 347 800 0000	00	142 345 600		12	8	150	100	50	7.5	B7G	P
	12CU6	020 740 310 0000	80	020 540 310	A1	12	22	250	150	57	5.8	AO8	P
	12CX6	412 387 100 0000	00	412 365 100		12.6	0	12	12	3	3.1	B7G	P
	12D4	001 090 230 0000	00	**1 *8* 230		12						AO8	D

SPEC.	VALVE TYPE NUMBER	PIN CONNECTIONS				CHARACTERISTICS						BASE	VALVE CLASS
		VCM163 Tester Only		CT160, VT160, VCM Mk 1,2,3,4		Vh	Vg1	Va	Vg2	la	gm mA/V		
		SELECTOR SWITCH	TOP CAP	SELECTOR SWITCH	TOP CAP	V	V	V	V	mA	†Ra MΩ		
	12D26	412 387 100 0000	00	412 365 100		12.6		12	12	4.5	3.8	B7G	P
	12DA6	041 230 871 0000	00	041 230 651		12	1	200	100	12	4.4	B9A	P
	12DB5	814 234 108 0000	00	614 234 1*6		12.6	9.6	200	125	46	8	B9A	P
	12DE8	419 238 171 0000	00	418 236 151		12.6	0.8	12	12	1.3	1.5	B9A	DP
	12DF5	901 22X 013 0000	00	801 229 013		6.3				30		B9A	RR
	12DF7	841 228 513 0000	00	641 227 413		6.3	2	250		1.2	1.6	B9A	TT
	12DJ8	841 238 510 0000	00	641 237 410		12.6	1.3	100		15	12.5	B9A	TT
	12DK5	141 230 871 0000	00	141 230 651		12.6	0	12	12	2	3.3	B9A	P
	12DK6	412 387 100 0000	00	412 387 100		12.6	0.9	125	125	12	9.8	B7G	P
	12DK7	141 223 871 0000	00	141 223 651		6.3	0	12	12	6	5	B9A	P
	12DL4	414 234 484 0000	00	414 234 464		12		150		12.5	14	B9A	T
	12LD6	917 238 41X 0000	00	815 236 419		12.6	2.5	12	12	3.8	6.5	B9A	DDP
	12DL8	914 238 71X 0000	00	814 236 519		12.6	0.5	12	12	40	15	B9A	DDP
	12DM4	001 090 320 0000	00	0*1 080 230		12.6				180		B9A	R
	12DM5	142 347 800 0000	00	142 345 600		12.6	7.5	150	100	49	7.5	B7G	P
	12DM6	704 234 108 0000	00	504 234 106		12	12.5	250	250	45	4.1	B9A	P
	12DM7	841 228 513 0000	00	641 227 413		6.3	2	250		1.2	1.6	B9A	TT
	12DQ4	001 090 230 0000	00	001 080 230		12.6				120		AO8	R
	12DQ6	020 740 310 0000	80	020 540 310	A1	12	22.5	250	150	75	6.6	AO8	P
	12DQ7	141 223 871 0000	00	141 223 651		6.3	2.1	100	125	26	10.5	B9A	P
	12DS7	907 238 41X 0000	00	805 236 419		12.6	2	12	12	40		B9A	DDP
	12DT1	412 39X 800 0000	00	412 389 600		12.6	3	250		1	1.2	B7G	DDT
	12DT2	412 39X 800 0000	00	412 389 600		12.6	2	250		1.1	1.6	B7G	DDT
	12DT5	704 234 108 0000	00	504 234 1*6		12.6	16.5	250	250	38	6.2	B9A	P
	12DT6	412 387 100 0000	00	412 365 100		12.6	2.2	150	100	1.1	1.8	B7G	P
	12DT7	841 228 513 0000	00	641 227 413		6.3	2	250		1.2	1.6	B9A	TT
	12DT8	841 238 510 0000	00	741 236 410		12.6	2.5	250		10	5.5	B9A	TT
	12DU7	417 238 90X 0000	00	415 236 8*9		12.6	0	12	12	12	6.2	B9A	DDP
	12DV7	1X9 228 413 0000	00	198 226 413		12.6	0	12		0.4	0.7	B9A	DDT
	12DV8	X14 238 719 0000	00	914 236 518		12.6	1.0	12.6	12.6	6.8		B9A	DDP
	12DW5	704 234 108 0000	00	504 234 106		12.6	22.5	200	150	55	5.5	B9A	P
	12DW7	851 238 410 0000	00	641 337 412		6.3	2	250		1.2	1.6	B9A	TT
	12DW7	851 238 410 0000	00	641 337 412		6.3	8.5	250		10.5	2.2	B9A	TT
	12DW8	851 238 419 0000	00	641 237 418		12.6	0	12.6		1.9	2.7	B9A	DTT
	12DW8	851 238 419 0000	00	641 237 418		12.6	0	12.6		7.5	6.5	B9A	DTT
	12DY8	517 238 184 0000	00	415 237 164		12.6	0	12		1.2	2	B9A	TP
	12DY8	517 238 184 0000	00	415 237 164		12.6		12	12	14	6	B9A	TP
	12DZ6	412 387 100 0000	00	412 365 100		12.6	0	12	12	4.5	3.8	B7G	P
	12DZ8	415 238 718 0000	00	414 236 517		12	1.2	120		0.8	1.4	B9A	TP
	12DZ8	415 238 718 0000	00	414 236 517		12	9	150	125	45	7.5	B9A	TP
	12E1	020 740 310 0000	80	020 540 310	A1	6.3	18	150	150	75	9.8	AO8	T
	12E1C	030 740 310 0000	80	*30 540 210	A1	6.3	10	150	150	200	14	AO8	P
	12E4	751 238 584 0000	00	541 237 464		12.6	2.6	200		5.4		B9A	TH
	12E4	751 238 584 0000	00	541 237 464		12.6		200	100	3.7		B9A	TH
	12E5	028 040 310 0000	00	026 040 310		12.5	13.5	250		5	1.4	AO8	T
	12E8	020 048 310 0000	50	027 546 310	G1	12		100		3.3		AO8	TH
	12E8	028 750 310 0000	50	027 546 310	G1	12	2	100	100	3	0.5	AO8	TH
	12E14	030 740 210 0000	80	*30 540 210	A1	6.3	10	150	150	200	14	AO8	P
	12EA6	412 387 100 0000	00	412 365 100		12.6		12	12	3.2	3.8	B7G	P
	12EC8	481 238 715 0000	00	461 237 514		12.6	0	12		2.4	4.7	B9A	TP
	12EC8	481 238 715 0000	00	461 237 514		12.6	0	12	12	0.6	2	B9A	TP
	12ED5	142 347 800 0000	00	142 345 600		12.6	4.0	100	100	32	8.1	B7G	P
	12EF6	028 740 310 0000	00	026 540 310		12.6	18	250	250	50	5.0	AO8	P

SPEC.	VALVE TYPE NUMBER	PIN CONNECTIONS				CHARACTERISTICS						BASE	VALVE CLASS
		VCM163 Tester Only		CT160, VT160, VCM Mk 1,2,3,4		Vh	Vg1	Va	Vg2	Ia	gm mA/V		
		SELECTOR SWITCH	TOP CAP	SELECTOR SWITCH	TOP CAP	V	V	V	V	mA	†Ra MΩ		
	12EG6	412 387 400 0000	00	412 365 400		12.6	0.8	12.6	12.6	0.4	1.0	B7G	H
	12EH5	142 234 800 0000	00	142 345 600		12.6	3.2	100	125	42	14.6	B7G	P
	12EK6	412 387 100 0000	00	412 365 100		12.6	0	12	12	4.4	4.2	B7G	P
	12EL6	482 3X9 100 1000	00	462 398 100		12.6	0	12		0.7	1.2	B7G	DDT
	12EM6	417 238 009 0000	00	415 236 **8		12.6	0	12	12	6	5	B9A	DP
	12EN6	028 740 310 0000	00	026 540 310		12.6	9.5	200	100	50	8.0	AO8	P
	12EQ7	141 237 890 0000	00	141 235 680		12.6	0	100	100	9	3.9	B9A	DP
	12ES5	142 380 100 0000	00	142 360 100		12.6	1	200		10	9.4	B7G	T
	12EX6	412 387 100 0000	00	412 365 100		12.6	1.0	12	12	2.4	4	B7G	P
	12EZ6	412 387 100 0000	00	412 365 100		12.6	0.7	12	12	1.9	2.7	B7G	P
	12F	290 300 000 0000	00	280 300 000		5				60		UX4	R
	12F5	020 800 310 0000	40	020 600 310	G1	12.5	2	250		0.9	1.5	AO8	T
	12F8	978 23X 141 0000	00	856 239 141		12.6	0	12	12	1	1	B9A	DDP
	12F31	412 387 100 0000	00	412 365 100		12	1	100	100	10.8	4.3	B7G	P
	12FK6	412 39X 800 0000	00	412 389 600		12.6	0	12		1.3	1.2	B7G	DDT
	12FM6	412 3X9 800 0000	00	412 398 600		12.6	0	12		1	1.3	B7G	DDT
	12FQ8	858 238 481 0000	00	747 236 461		12	1	200		3	1.5	B9A	TT
	12FR8	415 327 898 0000	00	414 325 786		12.6	0.6	12		1	1.2	B9A	DTP
	12FR8	415 327 898 0000	00	414 325 786		12.6	0.8	12	12	1.9	2.7	B9A	DTP
	12FT6	412 39X 800 0000	00	412 389 600		12.6	0	12.6		0.6	1	B7G	DDT
	12FX5	142 347 800 0000	00	142 345 600		12.6	0	150	130	36	13.5	B7G	P
	12FX8	758 324 181 0000	00	547 324 161		12.6	0	12.6		1.3	1.4	B9A	TH
	12FX8	758 324 181 0000	00	547 324 161		12.6	0	12.6		0.3	0.3	B9A	TH
	12G4	802 384 100 0000	00	602 364 100		12	8	250		10	3	B7G	T
	12G7	028 X90 310 0000	40	026 980 310	G1	12.5	3	250			1.2	AO8	DDT
	12G8	815 228 143 0000	00	714 226 143		6.3	12.6			7.2	2.6	B9A	TT
	12GA6	412 388 100 0000	00	412 366 100		12.6	0	12.6	12.6	0.3	0.14	B7G	O
	12GB3	020 740 310 0000	80	*2* 540*310	A1	12.6	7.7	100	100	100	14	AO8	P
	12GB6	020 740 080 0000	80	020 540 070	A1	12.6	22.5	250	150	57	5.9	AO8	P
	12G87	020 740 310 0000	80	020 540 310	A	12.6	7.7	100	100	100	14	AO8	P
	12GC6	217 434 000 0000	80	215 434 000	A	12.6	0	250	150	75	6.6	UX6	P
	12GE5	274 100 800 1430	00	-		12.6	22.5	250	150	65	7.3	A12	P
	12GE8	274 100 800 1430	00	-		12.6	22.5	250	150	65	7.3	A12	P
	12GJ5	741 234 700 0000	80	541 234 5**	A1	12.6	22.5	250	150	70	7.1	B9D	P
	12GK17	001 090 230 0000	00	001 080 230		12.6				120		AO8	R
	12GN6	412 387 900 0000	00	412 365 800		12.6	68	250	100	11	4.4	B7G	DP
	12GN7	111 230 871 0000	00	141 230 651		12.6	2	250	150	28	36	B9A	P
	12GT5	741 324 708 0000	00	541 324 5*6		12.6	22.5	250	150	70	7.1	B9D	P
	12GV5	207 140 704 1730	80	-		12.6	22.5	250	150	65	7.3	A12	P
	12GW6	020 740 310 0000	80	020 540 310	A1	12.6	22.5	250	150	70	7.1	AO8	P
	12H1C	418 158 230 0000	00	416 147 230		12.6	6.5	200		7.6	1.9	AO8	TT
	12H4	823 384 100 0000	00	623 364 100		6.3	8	250		9	2.6	B7G	T
	12H6	02X 190 310 0000	00	029 180 310		12.6						AO8	DD
	12H10C	084 581 230 0000	00	064 471 230		12.6	2	250		2	1.3	AO8	TT
	12H31	412 387 400 0000	00	412 365 400		12.6		100	100	2.8	0.4	B7G	H
	12HE7	290 180 014 0730	00	-		12.6				120		A12	RP
	12HE7	290 180 014 0730	00	-		12.6	22	125	125	60	8.8	A12	RP
	12HG7	141 230 871 0000	00	141 230 651		12.6	0	400	0	31	32.0	9BF	P
	12HL7	141 230 856 0000	00	141 230 645		12.6	0	400	0	25	21.0	B9A	P
	12J5	028 040 310 0000	00	026 040 310		12	8	250		9	2.6	AO8	T
	12J7	028 710 310 0000	40	026 510 310	G1	12.5	3	250	100	2	1.225	AO8	P
	12J8	417 238 19X 0000	00	415 236 189		12.6		12	12	12	5.5	B9A	DDP
	12JB6	741 234 710 0000	80	541 234 51*	A1	12.6	22.5	250	150	70	7.1	B9D	P

SPEC.	VALVE TYPE NUMBER	PIN CONNECTIONS				CHARACTERISTICS						BASE	VALVE CLASS
		VCM163 Tester Only		CT160, VT160, VCM Mk 1,2,3,4		Vh	Vg1	Va	Vg2	la	gm mA/V		
		SELECTOR SWITCH	TOP CAP	SELECTOR SWITCH	TOP CAP	V	V	V	V	mA	†Ra MΩ		
	12JB6A	741 234 710 0000	80	541 234 510	A	12.6	-22.5	150	150			B9A	P
	12JB6A	741 234 710 0000	80	541 234 510	A	12.6	0	60	150	1.0	7.1	B9A	P
	12JB6A	741 234 710 0000	80	541 234 510	A	12.6	22.5	250	150			B9A	P
	12JN6	217 100 800 1430	00	-		12.6	22.5	250	150	65	7.3	A12	P
	12JN8	481 238 715 0000	00	481 238 715		12.6	1	125		12	7.5	B9A	TP
	12JN8	481 238 715 0000	00	481 238 715		12.6	1	125	125	13.5	8.5	B9A	TP
	12JQ6	741 231 708 0000	00	541 231 506		12.6	-22.5	150	150			B9A	P
	12JQ6	741 231 708 0000	00	541 231 506		12.6	0	60	150	390	7.1	B9A	P
	12JQ6	741 231 708 0000	00	541 231 506		12.6	22.5	250	150	70		B9A	P
	12JT6	741 231 708 0000	00	541 231 5*6		12.6	22.5	250	150	70	7.1	B9D	P
	12K5	142 377 800 0000	00	142 355 600		12.6	2	12	12	8	7	B7G	P
	12K7	028 710 310 0000	40	026 510 310	G1	12.5	3	250	125	10.5	1.65	AO8	P
	12L6	028 740 310 0000	00	026 540 310		12	8.25	200	125	46	8	AO8	P
	12L8	514 872 380 0000	00	414 752 360		12.5	9	200	175	13	2.1	AO8	PP
	12M7	028 710 310 0000	40	026 510 310	G1	12	2.5	100	100	6	2.2	AO8	P
	12M71	271 084 130 0000	00	251 064 130		12.6	15	200	200	0.3	†0.5	B8B	TI
	12MD8	XY9 234 156 0000	00	996 234 144		12.6	0	330		11.5	3.1	TTT	
	12NK7	028 710 310 0000	40	026 510 310	G1	12.5	2	250	100	5	2.3	AO8	P
	12P1	412 387 100 0000	00	412 365 100		12.6	68	250	100	11	4.4	B7G	P
	12P2	412 387 100 0000	00	412 365 100		12.6	68	250	150	10.6	5.2	B7G	P
	12R5	142 347 800 0000	00	142 345 600		12.6	8.5	100	100	40	7	B7G	P
	12RK19	000 230 009 0000	10	*** 23* **8	C	12.6				120		B9A	R
	12RLL3	841 228 513 0000	00	641 227 413		12.6		150		10	5.5	B9A	TT
	12S8	Y19 X18 230 0000	40	†18 916 230	G1	12.5	2	250		0.9	1.1	AO8	DDDT
	12SA7	128 841 340 0000	00	126 641 340		12.5	3.6	100		12	4.3	AO8	H
	12SF5	014 080 320 0000	00	014 060 320		12.5	2	250		0.9	1.5	AO8	T
	12SF7	041 798 230 0000	00	041 586 230		12.5	1	250	100	19.9	2	AO8	DP
	12SG7	021 417 380 0000	00	021 415 360		12.5	1	250	125	11.8	4.7	AO8	P
	12SH7	021 417 380 0000	00	021 415 360		12.5	1	250	150	10.8	4.9	AO8	P
	12SJ7	021 417 380 0000	00	021 415 360		12.5	3	250	100	3	1.65	AO8	P
	12SK7	021 417 380 0000	00	021 415 360		12.5	3	250	100	9.2	2	AO8	P
	12SL7	481 581 230 0000	00	461 471 230		12.5	2	250		2.5	1.6	AO8	TT
	12SN7	481 581 230 0000	00	461 471 230		12.5	8	250		9	2.6	AO8	TT
	12SQ7	041 9X8 230 0000	00	941 896 230		12.5	2	250		0.9	1.1	AO8	DDT
	12SR7	041 X98 230 0000	00	041 986 230		12.5	9	250		9.5	1.9	AO8	DDT
	12SS7	021 417 380 0000	00	021 415 360		12.5	3	250	100	9	1.85	AO8	P
	12SW7	041 X98 230 0000	00	041 986 230		12.5	9	250		9.5	1.9	AO8	DDT
	12SX7	581 481 230 0000	00	471 461 230		12.5	8	250		9	2.6	AO8	TT
	12SY7	128 841 340 0000	00	126 641 340		12.5	1	100		22	4.5	AO8	H
	12TE8	528 748 310 0000	00	427 546 310		12		100		3.4		AO8	TH
	12TE8	528 748 310 0000	00	427 546 310		12		250	100	3.7		AO8	TH
	12TE9	508 230 450 0000	00	651 237 440		12		100		3.4	0.75	B9A	TH
	12TE9	071 238 550 0000	00	651 237 440		12		250	100	3		B9A	TH
	12T10	215 017 841 7830	00	-		12.6	8	250	250	37	6.5	A12	PP
	12T10	215 017 841 7830	00	-		12.6	1.9	150	100		1	A12	PP
	12U5	284 713 000 0000	00	264 513 000		12.6	22	250	250	0.2	†1.0	UX6	TI
	12U7	851 228 413 0000	00	741 226 413		6.3		12		1.2	1	B9A	TT
	12V6	028 740 310 0000	00	026 540 310		12.5	12.5	250	250	45	4.1	AO8	P
	12W6	028 740 310 0000	00	026 540 310		12	9.5	150	150	58	8.0	AO8	P
	12WC5	287 414 300 0000	00	265 414 300		12	1.5	250	100			UX7	P
	12X3	210 300 000 0000	90	210 300 000	D1	12.5				60		UX4	R
	12X4	902 30X 100 0000	00	802 309 100		12.5				30		B7G	RR

SPEC.	VALVE TYPE NUMBER	PIN CONNECTIONS				CHARACTERISTICS						BASE	VALVE CLASS
		VCM163 Tester Only		CT160, VT160, VCM Mk 1,2,3,4		Vh	Vg1	Va	Vg2	la	gm mA/V		
		SELECTOR SWITCH	TOP CAP	SELECTOR SWITCH	TOP CAP	V	V	V	V	mA	†Ra MΩ		
	12Y4	9X2 310 000 0000	00	892 310 000		12				31		UX4	RR
	12Z3	291 300 000 0000	00	281 300 000		12.6				30		UX4	R
	12Z4	291 300 000 0000	00	281 300 000		12.5				60		UX4	R
	12Z5	291 31X 200 0000	00	281 319 200		6.3				30		UX7	RR
	12ZDH3A	284 913 000 0000	00	264 813 000		12	2	250		1.5	1.5	UX6	DT
	12ZP1A	287 413 000 0000	00	265 413 000		12	9	200	200	30	2.3	UX6	P
	13	2X9 300 000 0000	00	298 300 000		5				60		UX4	RR
	13BCIU	208 091 X30 0000	40	206 081 930	G1	2.5	1.8	200		3	2	B8B	DDT
	12SF2U	208 791 X30 0000	40	206 581 930	G1	12.5	2.1	200	200	5	2	B8B	DDP
	13CM5	020 740 310 0000	80	020 540 310	A	12.8		100	100	100	14	AO8	P
	13D5	841 238 410 0000	00	741 226 413		6.3	8.5	250		1.6		B9A	TT
	13D7	148 231 085 0000	00	146 231 074		6.3		250		2.2	3.3	B9A	TT
	13D8	851 228 413 0000	00	741 226 413		6.3	8.5	250		10.5	2.2	B9A	TT
	13D9	851 228 413 0000	00	741 226 413		6.3	2	200			5.7	B9A	TT
	13DE7	855 238 410 0000	00	644 237 410		13	11	250		5.5	2	B9A	TT
	13DE7	855 238 410 0000	00	644 237 410		13	17.5	150		32	6.5	B9A	TT
	13DHA	X09 231 800 0000	40	908 231 600	G1	13	1.5	250		1	1.5	B7	DDT
	13DR7	855 238 410 0000	00	644 237 410		13	3	250		1.4	1.6	B9A	TT
	13DR7	855 238 410 0000	00	644 237 410		13	17.5	150		35	6.5	B9A	TT
	13E1	204 178 300 0000	00	2*4 156 300		26	14	150	150	500	35	B7A	T
	13E12	204 178 300 0000	00	2*4 156 300		26	30	150	150	500	25	B7A	P
	13EM7	581 481 230 0000	00	471 461 230		13	20	150		50	7.2	B9A	TT
	13EM7	581 481 230 0000	00	471 461 230		13	3	250		1.4	1.6	B9A	TT
	13F7	023 110 780 0000	40	023 110 560	G1	13	2	200	100	3	3.1	8SC	P
	13F9U	208 701 130 0000	40	206 501 130	G1	12.5	2.6	200	200	6.2	2.2	B8B	P
	13FD7	855 238 411 0000	00	644 237 411		6.3	3	250		1.4	1.6	B9A	TT
	13FD7	855 238 411 0000	00	644 237 411		6.3	17.5	150		40	7.5	B9A	TT
	13FG7	141 238 085 0000	00	141 236 074		13	20	150		50	7.2	B9A	TT
	13FG7	141 238 085 0000	00	141 236 074		13	3	250		1.4	1.6	B9A	TT
	13FM7	205 080 151 4830	00	-		13	3	250	2	2.2		A12	TT
	13FM7	205 080 151 4830	00	-		13	25	175	40	6		A12	TT
	13FR7	855 238 411 0000	00	644 237 411		13	3	250		1.4	1.6	B9A	TT
	13FR7	855 238 411 0000	00	644 237 411		13	20	150		50	7.2	B9A	TT
	13GB5	441 237 710 0000	80	441 235 510	A	13.0	10	75	200	440	P	B9A	P
	13GF7	151 238 084 0000	00	141 237 064		13	3	250		1.4	1.6	B9D	TT
	13GF7	151 238 084 0000	00	141 237 064		13	20	150		50	7.2	B9D	TT
	13H1	023 110 780 0000	40	023 110 560	G1	3	2	200	100	3	2	8SC	P
	13H2	023 110 780 0000	40	023 110 560	G1	13	3	200	100	8.2	1.8	8SC	P
	13J10	271 817 418 0530	00	-		13.2		100	100			A12	TP
	13J10	271 817 418 0530	00	-		13.2	8	125	250	35	6.5	A12	TP
	13M4V	208 747 132 0000	00	206 540 130		12.6	4.2	200	200		†1.0	AO8	TI
	13M4V	208 747 132 0000	00	206 540 130		12.6	12.5	200	200		†1.0	AO8	TI
	13SPA	081 231 700 0000	40	061 231 500	G1	13	3	200	100	2.3	1.7	B7	P
	13V1	013 19X 780 0000	40	013 189 560	G1	13	8.5	200	200	45	4.4	8SC	DDP
	13VPA	081 231 700 0000	40	061 231 500	G1	13	3	200	100	7	1.8	B7	P
	14	287 130 000 0000	40	265 130 000	G1	14	3	250	90	4	1	UX5	P
	14A4	280 004 130 0000	00	260 0*4 130		12.5	8	250		9	2.6	B8B	T
	14A5	287 004 130 0000	00	265 004 130		12.5	12.5	250	250	30	3	B8B	P
	14A7	287 104 130 0000	00	265 104 130		12.5	3	250	100	9.2	2	B8B	P
	14AF4	218 458 130 0000	00	216 447 130		12	10	250		9	2.1	B8B	TT
	14B6	284 09X 130 0000	00	264 *89 130		12.5	2	250		0.9	1.1	B8B	DDT

SPEC.	VALVE TYPE NUMBER	PIN CONNECTIONS				CHARACTERISTICS						BASE	VALVE CLASS
		VCM163 Tester Only		CT160, VT160, VCM Mk 1,2,3,4		Vh	Vg1	Va	Vg2	la	gm mA/V		
		SELECTOR SWITCH	TOP CAP	SELECTOR SWITCH	TOP CAP	V	V	V	V	mA	†Ra MΩ		
	14B8	287 474 130 0000	00	265 454 130		12.5	2	250	100		1.1	B8B	H
	14C5	287 004 130 0000	00	265 004 130		12.5	12.5	250	250	47	4.1	B8B	P
	14C7	287 114 130 0000	00	265 114 130		12.5	3	250	100	2.2	1.5	B8B	P
	14E6	284 0X9 130 0000	00	264 *98 130		12.5	8	250		9.3	1.9	B8B	DDT
	14E7	28X 974 130 0000	00	269 854 130		12.5	3	250	100	7.5	1.3	B8B	DDP
	14F6	028 740 310 0000	00	026 540 310		14	16.5	250	250	35	2.5	AO8	P
	14F7	218 548 130 0000	00	217 446 130		12.5	2	250		2.3	1.6	B8B	TT
	14F8	528 118 340 0000	00	427 116 340		12.5	3	250		6	3.3	B8B	TT
	14GT8	191 23X 148 0000	00	181 239 146		14	3	250		0.7	1.0		DDT
	14GW8	417 238 158 0000	00	415 237 146		14.7	1.7	250		1.2	1.6	B9A	TP
	14GW8	417 238 158 0000	00	415 237 146		14.7	7	250	250	36	10	B9A	TP
	14H7	287 114 130 0000	00	265 114 130		12.5	2	250	150	10	4.2	B8B	P
	14J7	208 405 130 0000	00	276 454 130		12.5	3	150		6.6	1.4	B8B	TH
	14J7	280 575 130 0000	00	276 454 130		12.5	3	250	100	1.4		B8B	TH
	14JG8	191 23X 148 0000	00	181 239 146		14	2	250		2	2.2	B9A	DDT
	14K7	208 405 130 0000	00	276 454 130		14	2	100		6.4	2.2	B8A	TH
	14K7	280 575 130 0000	00	276 454 130		14	2	200	90	2.7	1.5	B8A	TH
	14L7	284 0X9 130 0000	00	264 098 130		14	1.6	200		15	1.65	B8A	DDT
	14N7	218 548 130 0000	00	217 446 130		12.5	8	250		9	2.6	B8B	TT
	14Q7	288 414 130 0000	00	266 414 130		12.5	2	100		15	6	B8B	H
	14R7	28X 974 130 0000	00	269 854 130		12.5	1	250	100	6.2	3.4	B8B	DDP
	14S7	208 405 130 0000	00	276 454 130		12.5	1	100		4.8	1.4	B8B	TH
	14S7	280 575 130 0000	00	276 454 130		12.5	2	250	100	4	2	B8B	TH
	14V7	287 104 130 0000	00	265 104 130		12.5	2	300	150	9.6	5.8	B8B	P
	14W7	287 114 130 0000	00	265 114 130		12.5	2.2	300	150	10	5.8	B8B	P
	14X7	284 19X 130 0000	00	264 189 130		12.5	1	250		1.9	1.5	B8B	DDT
	14Y4	209 00X 130 0000	00	208 009 130		12.5				30		B8B	RR
	14Z3	291 300 000 0000	00	281 300 000		12.5				60		UX4	R
	15	284 300 000 0000	00	264 300 000		2.5	33	250		22	2.35	UX4	T
	15	287 130 000 0000	40	265 130 000	G1	2	1.5	150	75	1.85	0.75	UX5	P
	15A2	847 231 800 0000	00	645 231 700	G1	4	20	200		4		B7	H
	15A2	847 231 800 0000	00	645 231 700	G1	4	3	250	100	3.5		B7	H
	15A6	471 231 800 0000	00	451 231 600		15	2.9	200	175	36	10	B9A	P
	15A8	124 571 380 0000	80	124 451 360	A2	15	8	250		9	2.6	AO8	TP
	15A8	124 571 380 0000	80	124 451 360	A2	15	7.5	100	100	45	7.3	AO8	TP
	15AF11	285 814 181 7630	00	-		6.3	2	200		7	5.5	A12	TTP
	15AF11	285 814 181 7630	00	-		6.3	2	200		9.2	4.4	A12	TTP
	15AF11	285 814 181 7630	00	-		6.3	3	200	150	24	11	A12	TTP
	15BD7A	841 239 0X0 0000	00	641 238 090		15	1.5	200		1.5	1.6	B9A	DDT
	15BD11	285 814 181 7630	00	-		6.3	2	200		7.0	5.5	A12	TTP
	15BD11	285 814 181 7630	00	-		6.3	2	200		9.2	4.4	A12	TTP
	15BD11	285 814 181 7630	00	-		6.3	2.1	150	150	17	10.4	A12	TTP
	15CW5	071 230 807 0000	00	*51 23* 6*5		15	12.5	20C	175	70	10	B9A	P
	15D1	847 231 800 0000	00	645 231 700	G1	13	20	200		4		B7	H
	15D1	847 231 800 0000	00	645 231 700	G1	13	3	250	100	3.5		B7	H
	15DQ8	481 238 157 0000	00	461 237 145		15	1.7	200		3.0	4.0	B9A	TP
	15DQ8	481 238 157 0000	00	461 237 145		15	2.9	200	150	18	11	B9A	TP
	15E	280 701 300 0000	40	260 501 300	G1	2		150	75	1.8	0.7	B7G	P
	15EA7	481 581 230 0000	00	461 471 230		14.8	25	200		48	6.5	AO8	TT
	15EW6	412 387 100 0000	00	412 365 100		15	1	125	125	3.2	14	B7G	P
	15F80	741 231 800 0000	00	541 231 600		15		200	200	36	10	B9A	P
	15FM7	205 080 151 4830	00	-		14.8	3	250		2	2.2	A12	TT
	15FM7	205 080 151 4830	00	-		14.8	25	175		40	6	A12	TT



SPEC.	VALVE TYPE NUMBER	PIN CONNECTIONS				CHARACTERISTICS						BASE	VALVE CLASS
		VCM163 Tester Only		CT160, VT160, VCM Mk 1,2,3,4		Vh	Vg1	Va	Vg2	la	gm mA/V		
		SELECTOR SWITCH	TOP CAP	SELECTOR SWITCH	TOP CAP	V	V	V	V	mA	†Ra MΩ		
	15FY7	205 080 101 4830	00	-		14.7	3	250		1.4	1.6	A12	TT
	15FY7	205 080 101 4830	00	-		14.7	17.5	150		35	6.5	A12	TT
	15HB6	141 237 871 0000	00	141 235 651		14.7	4.6	250	250	40	20	B9A	P
	15KY8	151 238 784 0000	00	141 237 564		15	3	250		1.4	1.6	B9D	TP
	15KY8	151 238 784 0000	00	141 237 564		15	10	150	100	39	8.4	B9D	TP
	15KY8A	151 238 784 0000	00	141 237 564		15	3	250		1.4	1.6	B9D	TP
	15KY8A	151 238 784 0000	00	141 237 564		15	10	150	100	39	8.4	B9D	TP
	15LE8	811 230 174 0000	00	011 236 154		15	2.5	100	100	8	5.8	B9A	PP
	15LE8	011 238 174 0000	00	011 236 154		15	2.5	100	100	8	5.8	B9A	PP
	15TP7	481 238 157 0000	00	461 237 145		15	1.7	200		3	4	B9A	TP
	15TP7	481 238 157 0000	00	461 237 145		15	2.9	200	200	18	10.4	B9A	TP
	15X6	02X 190 310 0000	00	029 180 310		25				30		AO8	RR
	15YF7	205 080 101 4830	00	-		14.7	3	250		1.4	1.6	A12	TT
	15YF7	205 080 101 4830	00	-		14.7	17.5	150		35	6.5	A12	TT
	16	290 300 000 0000	00	280 300 000		7.5				60		UX4	R
	16A5	041 230 807 0000	00	*41 23* 6*5		16	14.2	200	200	45	7.5	B9A	P
	16A8	415 238 718 0000	00	414 237 516		16	1.5	200		1.7	2.4	B9A	TP
	16A8	415 238 718 0000	00	414 237 516		16	11.5	200	200	41	7.5	B9A	TP
	16AQ3	000 230 009 0000	10	*** 23* **8	C	16.4				180		B9A	R
	16B	290 300 000 0000	00	280 300 000		7.5				60		UX4	R
	16CN8	414 235 718 0000	-	414 237 516		16	1	100		3.3	3.6	B9A	TP
	16CN8	414 235 718 0000	-	414 237 516		16	16	200	200	35	6.4	B9A	TP
	16DS4	080 400 010 2030	00	-		6.3		100		6.5	9	NV	T
	16GK6	141 230 871 0000	00	141 230 651		16	7.4	250	250	48	11.3	B9A	P
	16GK8	415 238 718 0000	00	414 237 516		16		200		10	3.4	B9A	TP
	16GK8	415 238 718 0000	00	414 237 516		16		250	250	30	7.5	B9A	TP
	16GY5	207 140 704 1730	80	-		15.8	20	125	125	50	9.1	A12	P
	16KA6	207 140 000 1030	80	-		15.8	20	125	125	50	9.1	A12	P
	16L40	041 230 807 0000	00	041 230 605		16	14.2	200	200	45	7.6	B9A	P
	16N8	415 238 718 0000	00	414 237 516		15		100		3.3	3.6	B9A	TP
	16N8	415 238 718 0000	00	414 237 516		15	16	200	200	35	6.4	B9A	TP
	16TP6	151 234 887 0000	00	141 234 675		16		100		3.5	2.5	B9A	TP
	16TP6	151 234 887 0000	00	141 234 675		16	11.5	200	175	41	7.5	B9A	TP
	17	284 130 000 0000	00	264 130 000		14	6	90		2.7	0.8	UX5	T
	17AV5	421 080 370 0000	00	421 060 350		16	22.5	250	150	57	5.9	AO8	P
	17AX3	200 900 100 8030	00	-		16.3						A12	D
	17AX4	001 090 230 0000	00	001 080 230		16.8				120		AO8	R
	17AY3	090 230 910 0000	00	*8* 23* 810		16.8				120		B9D	R
	17AY3A	080 230 801 0000	00	060 230 601		16.8		32		350		B9A	R
	17BE3	200 900 100 9030	00	-		16.8				120		A12	R
	17BE11	215 017 841 7830	00	-		16.8	6	150	100	38	8.6	A12	PP
	17BE11	215 017 841 7830	00	-		16.8	1.8	150	100	1.3	1	A12	PP
	17BH3	090 230 901 0000	00	*8* 23* 8*1		17				180		B9D	R
	17BH3A	080 230 801 0000	00	060 230 601		17.0		32		350		B9A	R
	17BQ6	020 740 310 0000	80	020 540 310	A1	17	22.5	250	150	75	6.6	AO8	P
	17BS3	090 230 901 0000	00	*8* 23* 8*1		16.8				120		B9D	R
	17BS3A	080 230 801 0000	00	060 230 601		16.8		12		140		B9A	R
	17C5	142 347 800 0000	00	142 345 600		16	7.5	150	100	49	7.5	B7G	P
	17C8	741 238 9X1 0000	00	541 236 891		17	2	200	125	5	2.2	B9A	DDI
	17C9	478 231 578 1000	00	-		16.8	1	125	75	10	8	A10	PP
	17CA5	142 347 800 0000	00	142 345 600		16.8	4.0	100	100	32	8	B7G	P
	17CK3	080 230 801 0000	00	060 230 601		16.8		16		250		B9A	R
	17CT3	080 230 001 0000	00	060 230 001		16.8		16		350		B9A	R
	17CU5	142 347 800 0000	00	142 345 600		16.8	7.5	100	100	49	7.3	B7G	P
	17D1	98X 231 700 0000	40	869 231 500	G1	13	3	250	125	9	1.1	B7	DDP
	17D4	001 090 230 0000	00	**1 *8* 230		16.8				145		AO8	D

SPEC.	VALVE TYPE NUMBER	PIN CONNECTIONS				CHARACTERISTICS						BASE	VALVE CLASS
		VCM163 Tester Only		CT160, VT160, VCM Mk 1,2,3,4		Vh	Vg1	Va	Vg2	la	gm mA/V		
		SELECTOR SWITCH	TOP CAP	SELECTOR SWITCH	TOP CAP	V	V	V	V	mA	†Ra MΩ		
	17D4A	001 090 230 0000	00	**1 *8* 230		16.8				180		AO8	R
	17DA4	001 090 230 000	00	001 080 230		16.8				120		AO8	R
	17DE4	001 090 230 0000	00	001 080 230		17				120		AO8	R
	17DM4	001 090 230 0000	00	001 080 230		16.8				180		AO8	R
	17DM4A	018 230 000 0000	00	016 230 000		16.8		35		400		B5-85	R
	17DQ4	001 090 230 0000	00	001 080 230		16.8				120		AO8	R
	17DQ6	020 740 310 0000	80	020 540 310	A1	16	22.5	250	150	75	6	AO8	P
	17EW8	851 238 410 0000	00	741 236 410		17	1.1	100		4.5	4.6	B9A	TT
	17F6	041 230 887 0000	00	041 230 665		17	23	250	200	53	5.0	B9A	P
	17FL8	741 238 9X1 0000	00	541 236 891		17	1.5	200	100	11	4.5	B9A	DDP
	17GJ5	741 234 700 0000	80	541 234 5**	A1	16.8	22.5	250	150	70	7.1	B9D	P
		-	-	-			-22.5	150	150	390			-
	17GJ5A	741 234 700 0000	80	541 234 500	A	16.8	-22.5	250	150	70	7.1	B9A	P
	17GE5	274 100 800 1430	00	-		16.8	22.5	250	150	65	7.3	A12	P
	17GT5	741 234 708 0000	00	541 234 506		16.8	42	250	150	70	7.1	B9A	P
	17GT5A	741 234 708 0000	00	541 234 506		16.8	-22.5	250	150	70	7.1	B9A	P
	17GV5	207 140 704 1730	80	-		16.8	22.5	250	150	65	7.3	A12	P
	17GW6	020 740 310 0000	80	020 540 310	A1	16.8	22.5	250	150	70	7.1	B8A	P
	17GW8	417 238 158 0000	00	415 237 146		16.8	1.7	250		1.2	1.6	B9A	TP
	17GW8	417 238 158 0000	00	415 237 146		16.8	7.0	250	250	36	10	B9A	TP
	17H3	109 230 090 0000	00	108 230 080		17.5				60		B9A	D
	17HC8	415 238 718 0000	00	414 237 516		16.8	3	250		1.4	2	B9A	TP
	17HC8	415 238 718 0000	00	414 237 516		16.8	18	250	250	38	5.1	B9A	TP
	17JB6	741 234 710 0000	80	541 234 51*	A1	16.8	22.5	250	150	70	7.1	B9D	P
	17JG6	741 231 708 0000	00	541 231 5*6		16.8	20	150	100	80	10	B9D	P
	17JK8	851 238 410 0000	00	714 236 410		16.8	1.0	100		5.3	6.8	B9A	TT
	17JK8	851 238 410 0000	00	714 236 410		16.8	1.3	150		10	13	B9A	TT
	17JM6	217 140 000 1030	80	-		16.8	22.5	250	150	65	7.3	A12	P
	17JN6	217 100 800 1430	00	-		16.8	22.5	250	150	65	7.3	A12	P
	17JQ6	807 231 441 0000	00	605 231 441		17.0	-18	425	120	35	4.2	B9A	P
	17JQ6	807 231 441 0000	00	605 231 441		17.0	-18	425	140	35	4.2	B9A	P
	17JR6	741 231 708 0000	00	541 231 506		16.8	-20	130	125	45	7.0	B9A	P
	17JT6	741 231 708 0000	00	541 231 5*6		16.8	22.5	250	150	70	7.1	B9D	P
	17JZ8	280 805 571 4130	00	-		16.8	5	150		5.5	2.3	A12	TP
	17JZ8	280 805 571 4130	00	-		16.8	8	125	100	46	7.1	A12	TP
	17JZ8	280 805 571 4130	00	-		16.8	5	150		3.3	1.9	A12	TP
	17JZ8	280 805 571 4130	00	-		16.8	8	125	100	44	7.1	A12	TP
	17KV6	741 231 708 0000	00	541 231 506		16.8	-24.5	140	140	80	9.5	B9A	P
	17L6	028 740 310 0000	00	026 540 310		16.8	7.0	100	100	49	8	AO8	P
	17LD8	151 238 784 0000	00	101 236 564		16.8	5	150		3.3	1.9	B9A	TP
	17LD8	151 238 784 0000	00	101 236 564		16.8	8	125	100	44	7.1	B9A	TP
	17N8	741 238 9X1 0000	00	541 236 891		17	2	200	75	5	2.2	B9A	DDP
	17R5	142 347 800 0000	00	142 345 600		16.8	8.5	100	100	40	7	B7G	P
	17R7	000 230 009 0000	10	*** 23* **8	C	17				120		B9A	R
	17W6	028 740 310 0000	00	026 540 310		16.8	9	200	125	46	8	AO8	P
	17X10	271 817 418 0530	00	-		16.8		125	100	0.2		A12	PP
	17X10	271 817 418 0530	00	-		16.8	6	150	100	38	8.6	A12	PP

SPEC.	VALVE TYPE NUMBER	PIN CONNECTIONS				CHARACTERISTICS						BASE	VALVE CLASS
		VCM163 Tester Only		CT160, VT160, VCM Mk 1,2,3,4		Vh	Vg1	Va	Vg2	la	gm mA/V		
		SELECTOR SWITCH	TOP CAP	SELECTOR SWITCH	TOP CAP	V	V	V	V	mA	†Ra MΩ		
	17Z3	000 230 009 0000	10	*** 23* **8	C	17				120		B9A	R
	18	287 413 000 0000	00	265 413 000		14	16.5	250	250	34	2.5	UX6	P
	18A5	421 080 370 0000	00	421 060 350		18	17	200	125	40	4.8	AO8	P
	18AK5	412 387 100 0000	00	412 365 100		18	2.5	150	125	7.7	5.1	B7G	P
	18AQ5	412 387 100 0000	00	412 365 100		18	7.2	150	175	28	3.5	B7G	P
	18C51	214 808 513 0000	00	214 607 413		18	2	150		8.2	5.5	B9A	TT
	18D2	841 238 715 0000	00	641 237 514		9.5	1.8	150		12.5	10	B9A	TP
	18D2	811 238 715 0000	00	641 237 514		9.5	1.6	200	175	10	10	B9A	TP
	18D3	857 238 114 0000	00	645 237 114		6.3	1	150		18	8.5	B9A	TP
	18D3	857 238 114 0000	00	645 237 114		6.3	2	150	150	7	11	B9A	TP
	18DG6	412 387 100 0000	00	412 365 100		18	1	100	100	5	4.3	B7G	P
	18DZ8	415 238 718 0000	00	414 237 516		18	1.2	100		0.8	1.4	B9A	TP
	18DZ8	415 238 718 0000	00	414 237 516		18	9	150	125	45	7.5	B9A	TP
	18F24	281 174 130 0000	00	261 154 130		18	2.1	250	200	15	10.5	AO8	P
	18FW6	412 387 100 0000	00	412 365 100		18	1	100	100	11	4.4	B7G	P
	18FX6	412 387 100 0000	00	412 365 100		18		100	100	24	7	B7G	O
	18FX6A	412 387 100 0000	00	412 365 100		18.0	0	150	100	2.3	7.0	B7G	P
	18FY6	412 39X 800 0000	00	412 389 600		18	1	100		0.6	1.3	B7G	DDT
	18FY6A	412 300 800 0000	00	412 300 600		18.0	-1	100		0.6	1.3	B7G	DDT
	18FY6A	002 3X0 000 0000	00	002 398 000		18.0	-1	100		0.6	1.3	B7G	DDT
	18GD6	141 230 871 0000	00	141 230 651		18		100	100	5	4.3	B9A	P
	18GD6A	412 387 100 0000	00	412 365 100		18.0	-4.7	100	100	5	4.3	B7G	P
	18GE6	142 380 100 0000	00	142 360 100		18	1	100		1	1.7	B7G	T
	18GV8	841 238 715 0000	00	641 237 514		18	0.85	100		5	5.5	B9A	TP
	18GV8	841 238 715 0000	00	641 237 514		18	15	175	175	41	7	B9A	TP
	18HB8	418 237 815 0000	00	416 235 714		18	1	100		2.5	3.9	B9A	TP
	18HB8	418 237 815 0000	00	416 235 714		18	6	100	100	32	6.2	B9A	TP
	18J6	882 345 100 0000	00	672 344 100		18	1	100		6.5	5	B7G	TT
	19	384 582 000 0000	00	364 472 000		2	3	150		1.7		UX6	TT
	19A3	002 293 100 0000	00	002 283 100		9.5				60		B7G	R
	19AJ8	751 238 584 0000	00	541 237 164		19	3	100		5	2.3	B9A	TH
	19AJ8	751 238 584 0000	00	541 237 164		19	2	250	100	6.5	2.4	B9A	TH
	19AQ5	412 387 400 0000	00	412 365 400		19	12.5	250	200	47	4.1	B7G	P
	19AU4	001 090 230 0000	00	**1 080 230		19				120		AO8	R
	19BD	001 230 009 0000	00	**1 23* **8		19				60		B9A	R
	19BG6	021 040 370 0000	80	021 040 350	A1	19	15	250	250	75	6	AO8	P
	19BY7	141 213 871 0000	00	141 213 651		19	2	175	100	9.7	5.9	B9A	P
	19C8	9Y1 23X 148 0000	00	8†1 239 146		19	1	100		0.5	1.2	B9A	DDDT
	19CL8	481 238 715 0000	00	461 237 514		18.9	0.85	150		15	8	B9A	TP
	19CL8	481 238 715 0000	00	461 237 514		18.9	1	150	125	12	5.8	B9A	TP
	19CL8A	481 230 000 0000	00	461 230 000		18.9	1	125		14	8.0	B9A	TP
	19CL8A	000 238 714 0000	00	000 236 514		18.9	1.0	125	125	12	6.5	B9A	TP
	19D8	751 238 184 0000	00	541 237 464		19		100		13.5	3.7	B9A	TH
	19D8	751 238 184 0000	00	541 237 464		19	2.6	200	125	7.6	2.4	B9A	TH
	19DC8	741 238 9X1 0000	00	541 236 891		19	2	250	100	9	3.8	B9A	DDP
	17DE7	855 238 411 0000	00	644 237 411		19.5	11	250		5.5		B9A	TT
	17DE7	855 238 411 0000	00	644 237 411		19.5	17.5	150		35	6.5	B9A	TT
	19EA8	857 238 114 0000	00	645 237 114		18.9	1	150		18	8.5	B9A	TP
	19EA8	857 238 114 0000	00	645 237 114		18.9	1	150	125	12	6.4	B9A	TP
	19EH7	141 230 871 0000	00	141 230 651		19	2	200	100	13	13	B9A	P

SPEC.	VALVE TYPE NUMBER	PIN CONNECTIONS				CHARACTERISTICS						BASE	VALVE CLASS
		VCM163 Tester Only		CT160, VT160, VCM Mk 1,2,3,4		Vh	Vg1	Va	Vg2	la	gm mA/V		
		SELECTOR SWITCH	TOP CAP	SELECTOR SWITCH	TOP CAP	V	V	V	V	mA	†Ra MΩ		
19EJ7	141 230 871 0000	00		141 230 651		18.9	2.5	200	200	10	15	B9A	P
19FL8	741 238 9X1 0000	00		541 236 891		19	1.5	200	100	11	4.5	B9A	DDP
19G3	020 000 300 0000	90		020 000 300	D1	4				30		AO8	R
19G6	112 311 100 0000	90		112 311 100	D1	4				30		B7G	R
19GQ7	1Y0 23X 191 0000	00		1+ 239 181		18.9				5		B9A	ODD
19GV8	841 238 715 0000	00		641 237 514		18.9	0.6	100			6.5	B9A	TP
19GV8	841 238 715 0000	00		641 237 514		18.9	15	200	200	41	7.5	B9A	TP
19H1	002 300 000 0000	90		002 300 000	D1	4				60		B4	R
19H4	020 000 300 0000	90		020 000 300	D1	2.5				30		AO8	R
19HR6	412 387 100 0000	00		412 365 100		18.9	1.2	200	100	13.2	8.5	B7G	P
19HS6	412 387 100 0000	00		412 365 100		18.9	0.8	150	75	8.8	9.5	B7G	P
19HV8	481 238 715 0000	00		461 237 514		18.9	1.0	100		0.8	1.3	B9A	TP
19HV8	481 238 715 0000	00		461 237 514		18.9	1.0	150	150	13	7	B9A	TP
19J6	882 345 100 0000	00		762 344 100		19	1	100		8.5	5.3	B7G	TT
19JN8	481 238 715 0000	00		481 238 715		18.9	1	125		12	7.5	B9A	TP
19JN8	481 238 715 0000	00		481 238 715		18.9	1	125	125	13.5	8.5	B9A	TP
19MR9	412 387 400 0000	00		412 365 400		19	2.5	100	100	7	3.5	B7G	P
19MV5	412 387 400 0000	00		412 365 400		19	2	150	125	10	3.5	B7G	P
19Q9	578 231 148 0000	00		578 231 148		18.9	1	125		14	8	B9A	TP
19Q9	578 231 148 0000	00		578 231 148		18.9	1	125	125	12	6.5	B9A	TP
19R3	001 230 009 0000	00		001 230 008		19				180		B9A	R
19RLL1	214 808 513 0000	00		214 607 413		19	1.7	150		9	5.5	B9A	TT
19RLL2	841 238 510 0000	00		641 237 410		19	8.5	250		10.5	2.2	B9A	TT
19RP11	401 238 714 0000	00		401 236 514		19	7	100	100	35	5.5	B9A	P
19SU	001 230 009 0000	00		**1 23* **8		19				120		B9A	R
19T8	YX1 239 148 0000	00		†91 238 146		19	3	250		1.0	1.2	B9A	DDDT
19U3	001 230 009 0000	00		**1 23* **8		19				120		B9A	R
19V8	891 234 Y1X 0000	00		681 234 †19		19	3	250		1.0	1.2	B9A	DDDT
19W3	001 230 009 0000	00		**1 23* *08		19				120		B9A	R
19X8	148 231 578 0000	00		146 231 457		19	1	100		8.5	5.8	B9A	TP
19X8	148 231 578 0000	00		146 231 457		19	1.8	250	150	7.7	5.6	B9A	TP
19Y40	001 230 009 0000	00		001 230 008		19				180		B9A	R
20	384 200 000 0000	00		364 200 000		3	16.5	90		3	0.4	UX4	T
20A1	847 231 800 0000	50		645 231 700	G1	4	12.5	100		2.3		B7	TH
20A1	057 231 800 0000	50		645 231 700	G1	4	1.5	250	75	2.2		B7	TH
20A3	412 318 100 0000	00		412 316 100		6.3		400		50	6	B9A	P
20CH4U	218 745 830 0000	50		216 544 730	G2	20		200		4.1		B8A	TP
20CH4U	218 745 830 0000	50		216 544 730	G2	20	2	200	100	3.5	0.75	B8A	TP
20D1	192 310 X00 0000	00		182 310 900		9.5				5		B7G	RR
20D2	840 231 000 0000	50		645 231 600	G1	13	7.5	100		3.8		B7	TH
20D2	057 231 800 0000	50		645 231 600	G1	13	3	250	100	2.5		B7	TH
20D3	051 330 482 0000	00		541 227 463		6.3	1	100			3.6	B9A	TH
20D3	751 338 502 0000	00		541 227 463		6.3	3	250	100	3.6		B9A	TH
20D4	751 238 184 0000	00		541 237 164		6.3		100		15	3.5	B9A	TH
20D4	751 238 184 0000	00		541 237 164		6.3	2	250	100	7	2.8	B9A	TH
20EQ7	141 237 890 0000	00		141 235 680		20	0	100	100	9	10.9	B9A	DP
20EZ7	223 148 851 0000	00		223 146 741		10	1.0	150			1.6	B9A	TT
20F2	280 174 130 0000	00		260 154 130		11	1.2	150	150	27	10.6	B8A	P
20J8	029 748 310 0000	40		027 546 310	G1	20	1.5	100		1.5		AO8	H
20J8	029 748 310 0000	40		027 546 310	G1	20	3	250	100	1.5		AO8	H
20L1	285 184 130 0000	00		274 164 130		12	12	250		10	2.8	B8A	TT
20P1	020 740 310 0000	80		020 540 310	A1	38	30	200	200	80	6	AO8	P

SPEC.	VALVE TYPE NUMBER	PIN CONNECTIONS				CHARACTERISTICS						BASE	VALVE CLASS
		VCM163 Tester Only		CT160, VT160, VCM Mk 1,2,3,4		Vh	Vg1	Va	Vg2	Ia	gm mA/V		
		SELECTOR SWITCH	TOP CAP	SELECTOR SWITCH	TOP CAP	V	V	V	V	mA	†Ra MΩ		
	20P2	020 740 310 0000	80	020 540 310	A1	38	7.5	250	250		13.5	AO8	P
	20P3	028 740 310 0000	00	026 540 310		20	9.4	200	175	42	7.2	AO8	P
	20P4	020 740 310 0000	80	020 540 310	A1	38	33	200	200	100	6	AO8	P
	20P5	280 074 130 0000	00	260 054 130		20	6.3	200	150	29	7.5	AO8	P
	20RDHV1	157 238 984 0000	00	145 237 864		20	2	250		1.2	1.2	B9A	DTP
	20RDHV1	157 238 984 0000	00	145 237 864		20	1	250	100	9	3.5	B9A	DTP
	20Y1	023 100 090 0000	00	023 100 080		20				60		F8	R
	20Y40	000 230 009 0000	10	000 230 008	C	20				120		B9A	R
	21	287 413 000 0000	00	265 413 000		6.3	45	400	300	65		UX6	P
	21A6	041 230 071 0000	80	*41 23* *51	A1	21.5	28	200	200	40	6.0	B9A	P
	21A7	208 405 130 0000	00	276 454 130		21		150		3.5	0.3	B8B	TH
	21A7	280 575 130 0000	00	276 454 130		21	3	250	100	1.3	1.9	B8B	TH
	21B6	041 230 071 0000	80	041 230 051	A1	21	23	200	200	45	6.5	B9A	P
	21CW7	148 235 118 0000	00	146 234 117		21	1.5	90		12	6	B9A	TT
	21DJ8	841 238 510 0000	00	641 237 410		21	1.3	90		15	12.5	B9A	TT
	21EX6	021 040 370 0000	80	021 040 350	A1	21.5		200	150	67	7.7	AO8	P
	21GY5	207 140 704 1730	80	-		21	20	125	125	50	9.1	A12	P
	21HB5	274 100 800 1430	00	-		21	20	125	125	46	9.0	A12	P
	21HB5A	274 100 800 1430	00	254 100 600		21	20	130	130	46	9	A12	P
	21HD5	207 140 804 1730	00	-		21.5	22	150	150	65	10	A12	P
	21JV6	217 000 800 0430	00	215 000 600		21	20	130	130	50	9.1	A12	P
	21JZ6	217 040 000 0030	80	215 040 000		21	20	125	125	46	9.0	A12	P
	21KA6	207 140 000 1030	80	-		21	20	125	125	50	9.1	A12	P
	21L40	041 231 071 0000	80	041 231 051	A1	21.5	28	200	200	40	6	B9A	P
	21LR8	151 238 784 0000	00	041 236 564		21	4	250		2.3	3.6	B9A	TP
	21LR8	151 238 784 0000	00	041 236 564		21	10	150	125	56	9.3	B9A	TP
	21LU8	280 805 571 4130	00	-		21	4	250		2.3	3.6	A12	TP
	21LU8	280 805 571 4130	00	-		21	10	150	125	56	9.3	A12	TP
	21TH8	020 748 310 0000	50	027 546 310	G1	21		100		4	2	AO8	TH
	21TH8	028 750 310 0000	50	027 546 310	G1	21	2.5	200	90	3	0.7	AO8	TH
	22	387 200 000 0000	40	365 200 000	G1	3	1.5	150	50	1.7	0.3	UX4	P
	22AC	287 300 000 0000	40	265 300 000	G1	2.5	3	90	90	4	1.05	UX4	P
	22AQ3	000 230 009 0000	10	*** 23* **8	C	22				180		B9A	R
	22BH3	090 230 901 0000	00	*8* 23* 8*1		22.4				180		B9D	R
	22BW3	200 900 100 9030	00	-		22.4				120		A12	R
	22DE4	001 090 230 0000	00	001 080 230		22.4				120		AO8	R
	22FC7	148 235 118 0000	00	146 234 117		21.6	1.2	90		15	12.3	B9A	TT
	22JF6	741 234 710 0000	80	541 234 510	A	22.0	20	130	125	80	10.0	B9A	P
	22JG6	741 231 708 0000	00	541 231 5*6		22	20	130	125	80	10	B9D	P
	22JG6A	741 231 708 6000	00	541 231 506		22.0	20	130	125	80	10.0	B9D	P
	22JR6	741 231 708 0000	00	541 231 506		22.0	-20	125	125	45	7.0	B9A	P
	22JU6	741 234 710 0000	80	541 234 51*	A1	22	20	150	100	45	7	B9D	P
	22KM6	741 234 710 0000	80	541 234 510	A	22.0	-24.5	140	140	80	9.5	B9A	P
	22S/101G	192 310 X00 0000	00	182 310 900		6.3				5		B7G	R
	23	207 411 300 0000	80	205 411 300	A1	2.5	90	400	150	43		UX7	P
	23Z9	285 080 067 4830	00	267 060 000		23	2	150		5.4	3.9	A12	TTP
	23Z9	285 080 067 4830	00	267 060 000		23	5	150		5.5	2.4	A12	TTP
	23Z9	285 080 067 4830	00	267 060 000		23	8	120	110	46	7.1	A12	TTP

SPEC.	VALVE TYPE NUMBER	PIN CONNECTIONS				CHARACTERISTICS						BASE	VALVE CLASS
		VCM163 Tester Only		CT160, VT160, VCM Mk 1,2,3,4		Vh	Vg1	Va	Vg2	la	gm mA/V		
		SELECTOR SWITCH	TOP CAP	SELECTOR SWITCH	TOP CAP	V	V	V	V	mA	†Ra MΩ		
	24	284 300 000 0000	00	264 300 000		2	13.5	200		8	1.6	UX4	T
	24A	287 130 000 0000	40	265 130 000	G1	2.5	3	200	90	4	1	UX5	P
	24GA7	277 410 810 0930	00	-		24				120		A12	RP
	24GA7	277 410 810 0930	00	-		24	22.5	250	150	75	6.6	A12	RP
	24NG	291 1X3 000 0000	00	281 193 000		40						UX6	RR
	24S	287 130 000 0000	40	265 130 000	G1	2.5	3	200	90	4	1	UX5	P
	25	289 X43 000 0000	00	268 943 000		2	3	150		1.0	0.5	UX6	DDT
	25	205 411 300 0000	80	205 411 300	A1	6.3	90	400	150	43		UX7	P
	25A6	028 740 310 0000	00	026 540 310		25	18	150	125	33	2.3	AO8	P
	25A7	128 749 310 0000	00	126 548 310		25				60		AO8	RP
	25A7	128 749 310 0000	00	126 548 310		25	15	100	100	20.5	1.8	AO8	RP
	25ACID	208 009 030 0000	40	206 008 030	G1	1.4	0	150		0.76	0.4	AO8	DT
	25AC5	028 040 310 0000	00	026 040 310		25	0	200		4	3.8	AO8	T
	25AQ8	X41 238 410 0000	00	741 236 410		25	1.1	100		4.5	4.6	B9A	TT
	25AV5	421 080 370 0000	00	421 060 350		25	22.5	250	150	57	5.9	AO8	P
	25AX4	001 090 230 0000	00	001 080 230		25				120		AO8	R
	25B6	028 740 310 0000	00	026 540 310		25	22	150	150	61	5	AO8	P
	25B8	128 781 340 0000	50	127 561 340	G1	25	1	100		0.6	1.5	AO8	TP
	25B8	128 781 340 0000	50	127 561 340	G1	25	3	100	100	7.6	2	AO8	TP
	25BG6	021 040 370 0000	80	021 040 350	A1	25	22	150	150	70	5	AO8	P
	25BK5	804 231 470 0000	00	604 231 450		25	5	250	250	35	8.5	B9A	P
	25BQ6	020 740 310 0000	80	020 540 310	A1	25	22.5	250	150	55	5.5	AO8	P
	25C5	142 347 800 0000	00	142 345 600		25	7.5	150	100	49	7.5	B7G	P
	25C6	028 740 310 0000	00	026 540 310		25	14	200	150	61	7.1	AO8	P
	25CA5	142 347 800 0000	00	142 345 600		25	4.5	150	125	36	9.2	B7G	P
	25CD6	021 040 370 0000	80	021 040 350	A1	25	30	200	200	75	7.5	AO8	P
	25CD6GB	021 043 700 0000	80	021 043 500	A	25.0	-50	175	175	75	7.7	AO8	P
	25CG3	-	-	-		25.0		25		700		B9A	R
	25CK3	080 230 801 0000	00	060 230 601		25.2		16		1200		B9A	R
	25CM3	080 230 801 0000	00	060 230 601		25.0		10		350		B9A	R
	25CR5	174 231 741 0000	00	154 231 541		25	22.5	250	150	65	6	B9A	P
	25CU6	020 740 310 0000	80	020 540 310	A1	25	23	250	150	60	6	AO8	P
	25D4	001 090 230 0000	00	001 080 230		25				120		AO8	R
	25D8	128 748 390 0000	50	127 546 380	G1	25	1	100		0.5	1.1	AO8	DTR
	25D8	128 748 390 0000	50	127 546 380	G1	25	3	100	100	8.5	1.9	AO8	DTR
	25DK4	002 390 100 0000	00	002 380 100		25				60		B7G	R
	25DN6	021 040 370 0000	80	021 040 350	A1	25	18	125	125	70	9	AO8	P
	25DQ6	020 740 310 0000	80	020 540 310	A1	25	22.5	250	150	75	6	AO8	P
	25DT5	704 234 108 0000	00	504 234 1*6		25	16.5	250	250	38	6.5	B9A	P
	25E2	751 228 384 0000	00	541 227 365		12.6	2	200		6.5		B9A	TH
	25E2	751 228 305 0000	00	541 227 365		12.6		200	100	4		B9A	TH
	25E5	020 740 310 0000	80	020 540 310	A1	25	8.2	100	100	100	14	AO8	P
	25EC6	021 040 370 0000	80	021 040 350	A1	25	23	125	125	70	7.5	AO8	P
	25EH5	142 347 800 0000	00	142 345 600		25	3.2	100	125	42	14.6	B7G	P
	25F5	142 347 800 0000	00	142 345 600		25	7.5	100	100	37	5.8	B7G	P
	25F5A	142 347 800 0000	00	142 345 600		25.0	-7.5	110	110	43	6.4	B7G	P
	25F7	020 740 310 0000	80	020 540 310	A1	25	21	150	150	100	11	AO8	P
	25FG6	020 740 310 0000	80	*2* 540 310	A1	25	21	200	175	100	11	AO8	P
	25FID	208 701 040 0000	40	206 501 040	G1	1.4	2.5	150	125	1.2	0.7	AO8	P
	25FY8	415 238 871 8000	00	414 237 516		25	1.5	150		2.5	2	B9A	TP
	25FY8	415 238 871 8000	00	414 237 516		25	13.5	150	125	50	7	B9A	TP

SPEC.	VALVE TYPE NUMBER	PIN CONNECTIONS				CHARACTERISTICS						BASE	VALVE CLASS
		VCM163 Tester Only		CT160, VT160, VCM Mk 1,2,3,4		Vh	Vg1	Va	Vg2	la	gm mA/V		
		SELECTOR SWITCH	TOP CAP	SELECTOR SWITCH	TOP CAP	V	V	V	V	mA	†Ra MΩ		
	25GB6	020 740 310 0000	80	020 540 310	A1	25	22.5	250	150	6.5	6	AO8	P
	25JQ6	807 231 441 0000	00	605 231 441		25.2	120	40	120	35	4.2	B9A	P
	25L6	028 740 310 0000	00	026 540 310		25	8.2	200	125	47	8	AO8	P
	25MK15	002 390 100 0000	00	002 380 100		25				25		B7G	R
	25RE	291 1X3 000 0000	00	281 193 000		25				30		UX6	RR
	25S	289 X43 000 0000	00	268 943 000		2	3	150		0.8	0.6	UX6	DDT
	25SN7	481 581 230 0000	00	461 471 230		25	8	250		9	2.6	AO8	TT
	25T3G	020 000 310 0000	9X	020 000 310	D1D2	25				60		AO8	RR
	25V5	029 1X0 310 0000	00	028 190 310		25				60		AO8	R
	25W6	028 740 310 0000	00	026 540 310		25	8.5	250	125	46	8	AO8	P
	25W9	001 090 230 0000	00	001 080 230		25				120		AO8	R
	25X4	020 090 310 0000	00	020 080 310		25				120		AO8	R
	25X6	029 1X0 310 0000	00	028 190 310		25				30		AO8	RR
	25Y5	291 1X3 000 0000	00	281 193 000		25				60		UX6	RR
	25Y5G	029 1X0 310 0000	00	028 190 310		25				60		AO8	RR
	25Y6	029 1X0 310 0000	00	028 190 310		25				30		AO8	RR
	25Z3	291 300 000 0000	00	281 300 000		25				60		UX4	R
	25Z5	2X1 193 000 0000	00	291 183 000		25				60		UX6	RR
	25Z6	02X 190 310 0000	00	029 180 310		25				60		AO8	RR
	26	284 300 000 0000	00	264 300 000		1.5	10	150		5.5	1.1	UX4	T
	26A6	412 387 100 0000	00	412 365 100		26	1.8	250	250	10.5	4	B7G	P
	26A7	415 872 380 0000	00	414 752 360		26	4.5	30	30	20	5.5	AO8	PP
	26AE6	000 230 009 0000	10	*** 23* **8	C	26						B9A	R
	26AQ8	851 238 410 0000	00	641 237 410		26	1.5	200		8.7	6	B9A	TT
	26B6	028 740 310 0000	00	026 540 310		35	18	250	125	33	2.3	AO8	P
	26BK6	412 39X 800 0000	00	412 389 600		26	2	250		1.2	1.6	B7G	DDT
	26BQ6	020 740 310 0000	80	020 540 310	A1	25	22.5	250	150	55	5.8	AO8	T
	26C6	412 3X9 800 0000	00	412 398 600		26	9	250		9.5	1.9	B7G	DDT
	26CG6	412 387 100 0000	00	412 365 100		26	8	250	150	9	2	B7G	P
	26D6	412 387 100 0000	00	412 365 100		26	0	100	100	2.7	7.2	B7G	H
	26E6	028 740 310 0000	00	026 540 310		26	14	200	125	60	7.1	AO8	P
	26NG	291 1X3 000 0000	00	281 193 000		40				30		UX6	RR
	26Z5	901 22X 013 0000	00	801 229 013		13				30		B9A	RR
	26Z6	901 23X 010 0000	00	801 239 010		26				60		B9A	RR
	27	234 130 000 0000	00	264 130 000		2.5	21	250		5.2	0.9	UX5	T
	27BL8	857 238 114 0000	00	645 237 114		27	2	100		14	5	B9A	TP
	27BL8	857 238 114 0000	00	645 237 114		27	2	200	175	10	6.2	B9A	TP
	27HM	284 130 000 0000	00	264 130 000		2.5	13.5	180		5		B5B	T
	27SU	320 090 210 0000	00	320 080 210						120		AO8	R
	27SV	230 090 310 0000	00	230 080 310		13				180		AO8	R
	28AK8	9Y1 23X 148 0000	00	8†1 239 146		28	2	200		1.3	1.5	B9A	DDDT
	28AX8	9Y1 23X 148 0000	00	8†1 239 146		28	1	100		0.8	1.4	B9A	DDDT
	28D7	247 881 530 0000	00	245 671 430		28	3.5	30	30	12.5	3.4	B8B	PP
	28HD5	207 140 804 1730	00	-		28	22	150	150	65	10	A12	P
	28Z5	209 00X 130 0000	00	208 009 130		28				60		B8B	RR
	29	284 413 000 0000	00	264 413 000		2.5	3	200		4.5	1.4	UX6	T
	29C1	220 293 330 0000	00	220 283 330		4				3		AO8	D
	29GK6	141 230 871 0000	00	141 230 651		28.6	7.4	250	250	48	11.3	B9A	P
	30	384 200 000 0000	00	364 200 000		2	9	150		3	0.9	UX4	T
	30A5	142 347 800 0000	00	142 345 600		30	6.7	100	100	43	9.2	B7G	P
	30AE3	000 230 009 0000	10	*** 23* **8	C	30						B9A	D
	30AG11	219 158 841 X130	00	-		30	1	125	7.5	7.8		A12	DDTT

SPEC.	VALVE TYPE NUMBER	PIN CONNECTIONS				CHARACTERISTICS						BASE	VALVE CLASS
		VCM163 Tester Only		CT160, VT160, VCM Mk 1,2,3,4		Vh	Vg1	Va	Vg2	la	gm mA/V		
		SELECTOR SWITCH	TOP CAP	SELECTOR SWITCH	TOP CAP	V	V	V	V	mA	†Ra MΩ		
	30C1	857 238 114 0000	00	645 237 114		9	2	100		14	5	B9A	TP
	30C1	857 238 114 0000	00	645 237 114		9	2	200	200	10	6.6	B9A	TP
	30C13	178 238 415 0000	00	157 236 414		9	2	100		14	5	B9A	TP
	30C13	178 238 415 0000	00	157 236 414		9	2	200	175	10	6.2	B9A	TP
	30C15	178 238 415 0000	00	157 236 414		9	2	100		15	6	B9A	TP
	30C15	178 238 415 0000	00	157 236 414		9	2.5	200	150	10	9	B9A	TP
	30C17	178 238 415 0000	00	157 236 414		7.4	3.2	100		15	8.5	B9A	TP
	30C17	178 238 415 0000	00	157 236 414		7.4	1.5	125	125	10	11	B9A	TP
	30C18	878 231 514 0000	00	657 231 414		7.4	3	100		14	5.5	B9A	TP
	30C18	878 231 514 0000	00	657 231 414		7.4	1.5	125	125	10	11	B9A	TP
	30F5	141 230 871 0000	00	141 230 651		7.5	1.8	200	200	10	8.8	B9A	P
	30F27	141 230 871 0000	00	141 230 651		3.7	1.2	200	150	13.5	15	B9A	P
	30FL1	841 238 751 0000	00	641 237 541		9.4	1.9	200		10	3.6	B9A	TO
	30FL1	841 238 751 0000	00	641 237 541		9.4	2.7	200	200	10	7.5	B9A	TO
	30FL2	841 230 000 0000	00	641 230 000		10.4	7.7	200		10	3.4	B9A	TP
	30FL2	000 238 741 0000	00	000 236 541		10.4	2.0	170	170	10	8.0	B9A	TP
	30FL12	841 238 751 0000	00	641 237 541		10	4.9	150		10	3.7	B9A	TP
	30FL12	841 238 751 0000	00	641 237 541		10	2.9	200	200	10	12.5	B9A	TP
	30FL13	841 238 751 0000	00	641 237 541		10		200		10	3.4	B9A	TH
	30FL13	841 238 751 0000	00	641 237 541		10		200	200	10	12.5	B9A	TH
	30FL14	878 231 514 0000	00	657 231 414		7.4	3	100		14	5.5	B9A	TP
	30FL14	878 231 514 0000	00	657 231 414		7.4	1.7	150	150	12	14.5	B9A	TP
	30GP9	028 743 100 0000	00	026 543 100		30	19	200	200	45	3.5	AO8	P
	30L1	158 234 118 0000	00	147 234 116		7.5	1.5	90	12		6.0	B9A	TT
	30L15	158 324 118 0000	00	147 324 116		7	1.2	90		15	9	B9A	TT
	30L17	148 235 118 0000	00	146 234 117		7.2	0.8	75		15	16.5	B9A	TT
	30P4	020 740 310 0000	80	020 540 310	A1	25	8.2	100	100	100	14	AO8	P
	30P12	041 230 807 0000	00	*41 23* 6*5		12.6	10.3	200	200	31	6.7	B9A	P
	30P14	028 740 310 0000	00	026 540 310		13	9.4	200	200	42	7.2	AO8	P
	30P16	041 230 807 0000	00	041 230 605		16	14.2	200	200	45	8.2	B9A	P
	30P18	041 230 807 0000	00	041 23* 6*5		16	6	200	200	34	10	B9A	P
	30P19	020 740 310 0000	80	*2* 540 310	A1	25	8.5	100	100	100	15	AO8	P
	30PL1	841 238 175 0000	00	641 237 154		13	7.9	200		10	3.4	B9A	TP
	30PL1	841 238 175 0000	00	641 237 154		13	9.6	200	200	28	6	B9A	TP
	30PL12	415 238 718 0000	00	414 237 516		16	0	100		3.5	2.5	B9A	TP
	30PL12	415 238 718 0000	00	414 237 516		16	16	200	200	35	6.4	B9A	TP
	30PL13	415 238 718 0000	00	414 237 516		16	2.2	200		10	4.4	B9A	TP
	30PL13	415 238 718 0000	00	414 237 516		16	20	250	250	45	17.5	B9A	TP
	30PL14	415 238 718 0000	00	414 237 516		16	7.7	200		10	3.4	B9A	TP
	30PL14	415 238 718 0000	00	414 237 516		16	15	150	150	50	7.6	B9A	TP
	30PL15	841 238 715 0000	00	641 237 514		16	2.2	100		10	4.3	B9A	TP
	30PL15	841 238 715 0000	00	641 237 514		16	14.5	170	170	50	7.3	B9A	TP
	30X	284 300 000 0000	00	264 300 000		2	12.5	175		3.1	9.3	UX4	T
	31	384 200 000 0000	00	364 200 000		2	22.5	150		8	0.9	UX4	T
	31A3	290 000 130 0000	00	280 000 130		31				60		B8A	R
	31AV3	001 230 009 0000	00	**1 23** 8		31				60		B9A	R
	31JS6	217 140 000 1730	80	-		31.5	28	175	125	100	11.3	A12	P
	31JS6A	217 040 000 0730	80	215 040 000	A	31.5	25	175	125	125	11.3	A12	P
	312	245 300 000 0000	80	244 300 000	A1/A2	6.3	100	400		75	2.8	UX4	TT
	312	245 300 000 0000	08	244 300 000	A1/A2	6.3	15	400		75		UX4	TT
	32	387 200 000 0000	40	365 200 000	G1	2	3	150	75	1.7	0.6	UX4	P
	32A8	415 238 718 0000	00	414 237 516		32	1	100		1	1.9	B9A	TP
	32A8	415 238 718 0000	00	414 237 516		32	16	200	200	35	6.4	B9A	TP
	32BX7	481 581 230 0000	00	461 471 230		31.5	17	250		42	7.2	AO8	TT
	32E	387 200 000 0000	40	365 200 000	G1	2	3	150	75	1.7	0.6	UX4	P
	32ET5	142 347 800 0000	00	142 345 600		32	7.5	100	100	30	5.5	B7G	P



SPEC.	VALVE TYPE NUMBER	PIN CONNECTIONS				CHARACTERISTICS						BASE	VALVE CLASS
		VCM163 Tester Only		CT160, VT160, VCM Mk 1,2,3,4		Vh	Vg1	Va	Vg2	la	gm mA/V		
		SELECTOR SWITCH	TOP CAP	SELECTOR SWITCH	TOP CAP	V	V	V	V	mA	†Ra MΩ		
	32ET5A	142 347 800 0000	00	142 345 600		32.0	-7.5	1.10	110	30	5.5	B7G	P
	32GA7	277 410 810 0930	00	-		32				120		A12	RP
	32GA7	277 410 810 0930	00	-		32	22.5	250	150	75	6.6	A12	RP
	32L7	128 749 310 0000	00	126 548 310		32.5				60		AO8	RP
	32L7	128 749 310 0000	00	126 548 310		32.5	5	90	90	38	6	AO8	RP
	33	384 720 000 0000	00	364 520 000		2	14	150	150	14.5	1.4	Sm7	P
	33/100A	020 540 310 0000	88	020 440 310	A1/A2	6.3	14	300		10	3	AO8	TT
	33A/101K	841 228 513 0000	00	641 227 413		6.3	2	250		1.2	1.6	B9A	TT
	33A/138A	204 150 300 0000	88	204 140 300	A1/A2	7	7	250		15	3	UX7	TT
	33A/158M	218 458 130 0000	00	216 447 130		6.3	5	200		20	2.8	B8B	TT
	33B/152M	521 342 135 0000	88	421 342 134	A1/A2	6.3	1	300		40	18.5	B9G	TT
	33GT7	290 180 014 7430	00	-		33.6	22.5	125	125	48	6.5	A12	DP
	33GY7	290 180 014 4730	00	280 160 014		33.6	22.5	130	130	48	6.5	A12	DP
	33GY7	290 180 014 4730	00	-		33.6	22.5	125	125	48	6.5	A12	DP
	33JR6	741 236 708 0000	00	541 231 506		33.0	-20	125	125	45	7.0	B9A	P
	33JV6	215 100 800 1430	00	-		33	20	125	125	50	9.1	A12	P
	34	204 150 300 0000	88	204 140 300	A1/A2	6.3	36	300		80	4.4	UX7	TT
	34	387 200 000 0000	40	365 200 000	G1	2	3	150	75	2.8	0.6	UX4	P
	34E	387 200 000 0000	40	365 200 000	G1	2	3	150	75	2.8	0.6	UX4	P
	34CE3	200 900 100 9030	00	-		34.5				180		A12	R
	34CM3	080 230 801 0000	00	080 230 801		33.5		10		350		B9A	R
	34GD5	142 317 800 0000	00	142 315 600		34	7.5	100	100	35	5.7	B7G	P
	34GD5A	142 347 800 6000	00	142 345 600		34.0	-7.5	1.10	110	.35	5.7	B7G	P
	35	287 130 000 0000	40	265 130 000	G1	2.5	3	250	90	6.5	1	UX5	P
	35A3	002 390 100 0000	00	002 380 100		35				60		B7G	R
	35A5	287 004 130 0000	00	265 004 130		35	8	200	100	41	5.9	B8B	P
	35B5	412 387 400 0000	00	412 365 400		35	7.5	150	100	40	5.8	B7G	P
	35C3	002 390 100 0000	00	002 380 100		35				60		B7G	R
	35C5	142 347 800 0000	00	142 345 600		35	7.5	150	100	40	5.8	B7G	P
	35CD6	021 040 370 0000	80	021 040 350	A1	35	30	200	175	75	7.7	AO8	P
	35D5	401 238 070 0000	00	401 236 050		35	10.5	200	175	52	9.5	B9A	P
	35DZ8	415 238 718 0000	00	414 237 516		35	1.2	150		0.8	1.4	B9A	TP
	35DZ8	415 238 718 0000	00	414 237 516		35	9	150	125	45	7.5	B9A	TP
	35EH5	142 347 800 0000	00	142 345 600		35	62	100	100	3.2	12	B7G	P
	35F4	412 387 400 0000	00	412 365 400		35	7.5	100	100	41	5.8	B7G	P
	35F6	041 230 887 0000	00	041 230 665		35	23	250	200	55	5	B9A	P
	35FN5	721 441 370 0000	80	521 441 350	A1	35	22.5	200	150	100	10	B8A	P
	35GD5A	142 347 800 0000	00	142 345 600		34	7.5	100	100	45	7.5	B7G	P
	35GL6	142 273 800 0000	00	142 253 600		35	7.5	100	100	45	7.5	B7G	P
	35HB8	418 237 815 0000	00	416 235 714		35	1	100		2.5	3.9	B9A	TP
	35HB8	418 237 815 0000	00	416 235 714		35	6	100	100	32	6.2	B9A	TP
	35L6	028 740 310 0000	00	026 540 310		35	7.5	200	100	40	5.8	AO8	P
	35L31	412 387 400 0000	00	412 365 400		35	13	200	200	55	8	B7G	P
	35QL6	471 238 174 0000	00	451 236 154		35	11.5	200	200	52	9.5	B8A	P
	35R1	002 392 100 0000	00	002 382 100		35				60		B7G	R
	35R2	002 390 100 0000	00	002 380 100		35				60		B7G	R
	35RE	291 1X3 000 0000	00	281 193 000		35				60		UX6	RR
	35S	287 120 000 0000	40	265 120 000	G1	2.5	3	250	90	6.5	10.8	UX5	P
	35W4	002 393 100 0000	00	002 383 100		27.5				60		B7G	R
	35X4	002 390 100 0000	00	002 380 100		35				60		B7G	R
	35Y4	290 200 130 0000	00	280 200 130		27.5				60		B8B	R
	35Y31	002 390 100 0000	00	002 380 100		35				120		B7G	R

SPEC.	VALVE TYPE NUMBER	PIN CONNECTIONS				CHARACTERISTICS						BASE	VALVE CLASS
		VCM163 Tester Only		CT160, VT160, VCM Mk 1,2,3,4		Vh	Vg1	Va	Vg2	la	gm mA/V		
		SELECTOR SWITCH	TOP CAP	SELECTOR SWITCH	TOP CAP	V	V	V	V	mA	†Ra MΩ		
	35Z3	290 000 130 0000	00	280 000 130		35				120		B8B	R
	35Z4	020 090 310 0000	00	020 080 310		35				120		AO8	R
	35Z5	020 090 310 0000	00	022 080 310		27.5				60		AO8	R
	35Z6	029 1X0 310 0000	00	028 190 310		35				60		AO8	RR
	36	287 130 000 0000	40	265 130 000	G1	6.3	3	250	90	3.2	1	UX5	P
	36AM3	002 293 100 0000	00	002 283 100		36				60		B7G	R
	36AM3B	002 380 100 0000	00	002 360 100		36.0		16		150		B7G	R
	37	284 130 000 0000	00	264 130 000		6.3	18	250		7.5	1.1	UX5	T
	38	287 130 000 0000	40	265 130 000	G1	6.3	18	200	200	14	1	UX5	P
	38A3	001 230 009 0000	00	**1 23* *8		38				60		B9A	R
	38HE7	290 180 014 0730	00	-		37.8	22	125	125	60	8.8	A12	RP
	38HK7	290 180 014 0730	00	-		37.8	22	130	130	60	8.8	A12	DP
	38R3	001 230 009 0000	00	001 230 008		38				100		B9A	R
	39	280 701 300 0000	40	260 501 300	G1	6.3	3	250	90	5.8	1	B7G	P
	39	287 130 000 0000	40	265 130 000	G1	6.3	3	200	90	5.8	1	UX5	P
	40	384 200 000 0000	00	364 200 000		5	1.5	200		0.2	0.2	UX4	T
	40FR5	142 347 800 0000	00	142 345 600		40	7.5	125	125	35	6.0	B7G	P
	40KD6	217 040 004 0730	80	-	A	40	22.5	150	110	120	14	A12	P
	40PPA	047 231 800 0000	00	045 231 600		40	25	150	150	36	2	B7	P
	40SUA	902 310 000 0000	00	802 310 000		40				60		B5	R
	40Z5	022 090 310 0000	00	022 080 310		35				120		AO8	R
	41	287 413 000 0000	00	265 413 000		6.3	18	250	250	32	3.2	UX6	P
	41FP	842 310 000 0000	00	642 310 000		6.3	18	250		19	2.8	B5	T
	41M	028 740 310 0000	00	026 540 310		6.3	18	250	250	32	2.3	AO8	P
	41MDG	872 310 000 0000	40	652 310 000	G1	4	0	150	100		0.2	B5	P
	41ME	023 104 780 0000	00	023 104 560		4	5	250	250		†1.0	8SC	TI
	41MH	842 310 000 0000	00	642 310 000		4	1.5	200		3.2	3	B5	T
	41MHF	842 310 000 0000	00	642 310 000		4	2	150		2.5	2.8	B5	T
	41MHL	842 310 000 0000	00	642 310 000		4	3	200		4	4.1	B5	T
	41MLF	842 310 000 0000	00	642 310 000		4	4.5	200		7.5	1.9	B5	T
	41MP	842 310 000 0000	00	642 310 000		4	7.5	200		24	6.0	B5	T
	41MPG	474 231 800 0000	40	454 231 600	G1	4	1.5	250	100	3.3	0.9	B7	H
	41MPT	041 231 700 0000	80	041 231 500	A1	4	1.5	250	100	12	4.8	B7	P
	41MRC	842 310 000 0000	00	641 310 000		4	1	200		2.5	2.6	B5	T
	41MSG	487 230 785 0000	00	465 230 574		4	1.5	150	60	0.8	2.5	B9	PP
	41MSG	742 310 000 0000	80	542 310 000	A1	4	1.5	150	60	0.8	2.5	B5	P
	41MTA	842 310 000 0000	00	642 310 000		4	1	100		4.9	4	B9	T
	41MTB	842 310 000 0000	00	642 310 000		4	1	100		3.6	2.6	B5	T
	41MTL	842 310 000 0000	00	642 310 000		4	2.5	200		5.9	3	B5	T
	41MTS	047 231 800 0000	00	645 231 700		4	1	250	100	5	1.6	B7	PP
	41MTS	057 231 000 0000	80	645 231 700		4	1	250	100	5	1.6	B7	PP
	41MXP	842 310 000 0000	00	642 310 000		4	12.5	200		40	6	B5	T
	41MVSG	742 310 000 0000	80	542 310 000	A1	4	1.4	200	200	3	2	B5	P
	41STH	840 321 000 0000	50	645 231 700	G1	4	1.5	100		2		B7	TH
	41STH	057 321 800 0000	50	645 231 700	G1	4	1.5	200	60	1		B7	TH
	42	284 300 000 0000	00	264 300 000		1.5	13.5	150		3.9	0.8	UX4	T
	42	287 413 000 0000	00	265 413 000		6.3	16.5	250	250	34	2.5	UX6	P
	42MP/PEN	045 231 800 0000	00	045 231 600		4	5.5	250	250	32	6	B7	P
	42MPT	041 231 700 0000	80	041 231 500	A1	4(5)	3	200	200	34	8.5	B7	P
	42/OT	047 231 800 0000	00	045 231 600		4	5.5	250	275	34	7	B7	P

SPEC.	VALVE TYPE NUMBER	PIN CONNECTIONS				CHARACTERISTICS						BASE	VALVE CLASS
		VCM163 Tester Only		CT160, VT160, VCM Mk 1,2,3,4		Vh	Vg1	Va	Vg2	la	gm mA/V		
		SELECTOR SWITCH	TOP CAP	SELECTOR SWITCH	TOP CAP	V	V	V	V	mA	†Ra MΩ		
	420TDD	X89 231 700 0000	40	968 231 500	G1	4	5.5	250	250	34	7	B7	DDP
	42PTB	081 231 700 0000	40	061 231 500	G1	4	3	200	200	34	8.5	B7	P
	42SPT	041 231 700 0000	80	041 231 500	A1	4	10.5	250	250	64	11	B7	P
	43	284 583 000 0000	00	265 413 000		25	18	150	125	33	2.3	UX6	P
	43	287 413 000 0000	00	264 473 000		1.5	4.5	135		3	0.9	UX6	TT
	43	287 413 000 0000	00	264 473 000		1.5	20	135		14		UX6	TT
	43E	285 413 000 0000	00	265 413 000		25	18	150	125	33	2.3	UX6	P
	431U	9X2 300 000 0000	00	892 300 000		4				60		B4	RR
	43MG	028 740 300 0000	00	026 540 310		25	18	250	125	33	2.3	AO8	P
	44	287 130 000 0000	40	265 130 000	G1	6.3	3	200	90	5.8	1	UX5	P
	44A/160M	241 878 153 0000	00	241 657 143		6.3	14	250	250	30	3.9	B9G	PP
	44GW8	417 238 158 0000	00	415 237 146		44	1.7	250		1.2	1.6	B9A	TP
	44GW8	417 238 158 0000	00	415 237 146		44	7	250	250	36	10	B9A	TP
	44IU	9X2 300 000 0000	00	892 300 000		4				60		B4	RR
	44SU	902 300 000 0000	00	802 300 000		4				30		B4	R
	45	284 300 000 0000	00	264 300 000		2.5	50	250		34	2.1	UX4	T
	45A	284 300 000 0000	00	264 300 000		2.5	68	325		43	2.3	UX4	T
	45A5	280 074 130 0000	00	26* *54 130		45	9	200	200	54	9.5	B8A	P
	45B5	041 230 807 0000	00	041 23* 6*5		45	12.5	200	200	70	10	B9A	P
	45BQ5	041 230 807 0000	00	041 23* 6*5		45	12.5	300	175	70	10	B9A	P
	45DQ8	181 238 157 0000	00	461 237 145		45	1.7	200		3	4	B9A	TP
	45DQ8	181 238 157 0000	00	461 237 145		45	12.5	200	175	70	10	B9A	TP
	45DX8	481 238 157 0000	00	461 237 145		45	1.7	200		3	4	B9A	TP
	45DX8	481 238 157 0000	00	461 237 145		45	2.1	200	175	18		B9A	TP
	45IU	9X2 300 000 0000	00	892 300 000		4				120		B4	RR
	45LIU	208 740 130 0000	00	206 540 130		45	13	200	200	45	7.5	AO8	P
	45Z3	290 109 300 0000	00	28* 108 300		45				60		B7G	R
	45Z5	022 090 310 0000	00	022 080 310		37.5				60		AO8	R
	46	284 830 000 0000	00	264 630 000		2.5	33	250		22	2.3	UX5	T
	47	284 730 000 0000	00	264 530 000		2.5	16.5	250	250	31	2.5	UX5	P
	48	287 413 000 0000	00	265 413 000		30	10	100	100	52	3.8	UX6	P
	48A8	415 238 718 0000	00	414 237 516		48		100		3.5	2.5	B9A	TP
	48A8	415 238 718 0000	00	414 237 516		48	11.5	150	150	41	7.5	B9A	TP
	49	284 830 000 0000	00	264 630 000		2	20	150		6	1.1	UX5	T
	49	287 413 000 0000	00	265 413 000		6.3	50	400	250	95		UX6	P
	50	284 300 000 0000	00	264 300 000		7.5	70	400		55	2.1	UX4	T
	50A5	287 004 130 0000	00	265 004 130		50	7.5	150	100	49	8	B8B	P
	50AX6	029 1X0 310 0000	00	028 190 310		50				120		AO8	RR
	50B5	412 387 400 0000	00	412 365 400		50	7.5	150	100	49	7.5	B7G	P
	50BC1D	208 09X 030 0000	40	206 089 030	G1	1.4	0.5	90		1.4	0.8	AO8	DDT
	50BK5	804 231 470 0000	00	604 231 450		50	5	250	250	35	8.5	B9A	P
	50BM8	415 238 718 0000	00	414 237 516		50		100		3.5	2.5	B9A	TP
	50BM8	415 238 718 0000	00	414 237 516		50	10	150	150	41	7.5	B9A	TP
	50C5	142 347 800 0000	00	142 345 600		50	7.5	150	100	49	7.5	B7G	P
	50C6	028 740 310 0000	00	026 540 310		50	13.5	150	150	58	7	AO8	P
	50C1D	208 90X 030 0000	40	206 089 030	G1	1.4	1.5	100		1.5	0.9	AO8	DDT
	50CA5	142 347 800 0000	00	142 345 600		50	4.5	150	125	37	9.2	B7G	P
	50CD6	021 040 370 0000	80	021 040 350	A1	50	30	200	200	75	7.5	AO8	P
	50DC4	002 393 100 0000	00	002 363 100		25				60		B7G	R
	50EH5	142 347 800 0000	00	142 345 600		50	3.2	100	125	42	14.6	B7G	P
	50F2	412 387 400 0000	00	412 365 400		50	7.5	100	100	50	7.5	B7G	P

SPEC.	VALVE TYPE NUMBER	PIN CONNECTIONS				CHARACTERISTICS						BASE	VALVE CLASS
		VCM163 Tester Only		CT160, VT160, VCM Mk 1,2,3,4		Vh	Vg1	Va	Vg2	la	gm mA/V		
		SELECTOR SWITCH	TOP CAP	SELECTOR SWITCH	TOP CAP	V	V	V	V	mA	†Ra MΩ		
	50F2D	208 701 030 0000	40	206 501 030	G1	1.4	1.5	100	125	1.4	1	AO8	P
	50FA5	142 347 800 0000	00	142 345 600		50	7.5	100	100	40	5.8	B7G	P
	50FE5	028 740 310 0000	00	026 540 310		50	16	150	150	80	9.5	AO8	P
	50FK5	142 347 800 0000	00	142 345 600		50	2	100	100	32	12.8	B7G	P
	50FY8	415 238 718 0000	00	414 237 516		50	1.5	150		2.5	2	B9A	TP
	50FY8	415 238 718 0000	00	414 237 516		50	13.5	150	125	50	7.5	B9A	TP
	50LID	208 740 030 0000	00	206 540 030		1.4	4.5	100	125	4.8	1	AO8	P
	50L6	028 740 310 0000	00	026 540 310		50	8.2	200	125	46	9.5	AO8	P
	50L66T	028 043 100 0000	00	026 043 100		50.0	-7.5	200		50	9.5	B7G	-
	50R4	090 230 X01 0000	00	080 230 901		50				60		B9A	RR
	50RP1	141 238 719 0000	00	141 236 518		50				60		B9A	RP
	50RP1	141 238 719 0000	00	141 236 518		50	1	200	100	9	4.5	B9A	RP
	50X6	21X 009 130 0000	00	219 008 130		50				60		B8D	RR
	50YIU	399 209 120 0000	00	388 208 120		45				120		AO8	R
	50Y6	02X 190 310 0000	00	029 180 310		50				60		AO8	RR
	50Y7	029 1X3 310 0000	00	028 193 310		46				60		AO8	RR
	50Z6	02X 190 310 0000	00	029 180 310		50				120		AO8	RR
	50Z7	02X 190 310 0000	00	029 183 310		48				60		AO8	RR
	51	287 130 000 0000	40	265 130 000	G1	2.5	3	250	90	6.5	10.5	UX5	P
	52	284 730 000 0000	00	264 530 000		6.3	1	250	100	41	2	UX5	P
	52KU	030 X09 020 0000	00	030 908 020		5				60		AO8	RR
	53	285 148 300 0000	00	274 146 300		2.5	5	250		3	1.6	UX7	TT
	53KU	030 X09 020 0000	00	030 908 020		5				120		AO8	RR
	55	28X 913 000 0000	40	269 813 000	G1	2.5	20	250		8	1.1	UX6	DDT
	55A/165M	247 881 530 0000	00	245 761 430		12	15	150	150	60	4	B8B	PP
	55N3	001 230 009 0000	00	**1 23* **8		55				120		B9A	T
	56	284 130 000 0000	00	264 130 000		2.5	12.5	250		5	1.4	UX5	T
	56AS	284 130 000 0000	00	264 130 000		6.3	13.5	250		5	1.4	UX5	T
	57	287 113 000 0000	40	265 113 000	G1	2.5	3	250	100	2	1.2	UX6	P
	57AS	287 113 000 0000	40	265 113 000	G1	6.3	3	250	100	2	0.2	UX6	P
	58	287 113 000 0000	40	265 113 000	G1	2.5	3	250	100	8	1.5	UX6	P
	58AS	287 113 000 0000	40	265 113 000	G1	6.3	3	250	100	8	1.5	UX6	P
	58TF1	518 238 786 0000	40	417 231 564	G1	58	2	200		4	1.5	B9A	TPP
	58TF1	518 238 786 0000	40	417 231 564	G1	58	31	250	250	38	2.5	B9A	TPP
	59	287 411 300 0000	00	265 411 300		2.5	18	250	250	35	2.5	UX7	P
	59B	287 410 300 0000	00	265 410 300		2.5	26	250	250	26	6	UX7	P
	60	200 300 000 0000	9X	200 300 000	D1/D2	5				120		UX4	RR
	60/250	9X2 300 000 0000	00	892 300 000		4				30		B4	RR
	60E3	002 390 100 0000	00	002 380 100		60				60		B7G	R
	60FX5	142 347 800 0000	00	142 345 600		60	2	100	100	50	13.5	B7G	P
	61BT	020 740 310 0000	80	020 540 310	A1	6.3	20	200	200	40	4	AO8	P
	61SPT	720 804 310 0000	00	520 604 310		6.3	10.5	250	250	64	11	AO8	P
	62BT	020 740 310 0000	80	020 540 310	A1	6.3	19.5	250	175	100	9.5	B8A	P
	62DDT	284 0X9 130 0000	00	264 098 130		6.3	3	250		1	1.3	B8A	DDT
	62L31	412 367 400 0000	00	412 365 400		62	15	200	200	55	8	B7G	P
	62TH	208 405 130 0000	00	276 454 130		6.3	2	100		5	2.2	B8A	TH
	62TH	280 575 130 0000	00	276 454 130		6.3	2	150	100	8	2	B8A	TH
	62VP	281 174 130 0000	00	261 154 130		6.3	2.5	250	100	6	2.2	B8A	P
	63ME	028 740 310 0000	00	026 540 310		6.3	22	250	250	0.3	†1.0	AO8	TI
	63SPT	278 101 403 0000	00	256 101 403		6.3	2	250	250	10	6.5	B9G	P
	63TP	841 238 175 0000	00	641 237 154		6.3	2.3	100		4	1.4	B9A	TP
	63TP	841 238 175 0000	00	641 237 154		6.3	8	200	200	17.5	3.3	B9A	TP

SPEC.	VALVE TYPE NUMBER	PIN CONNECTIONS				CHARACTERISTICS						BASE	VALVE CLASS
		VCM163 Tester Only		CT160, VT160, VCM Mk 1,2,3,4		Vh	Vg1	Va	Vg2	la	gm mA/V		
		SELECTOR SWITCH	TOP CAP	SELECTOR SWITCH	TOP CAP	V	V	V	V	mA	†Ra MΩ		
64	280 101 300 0000	40	026 457 310	G1	6.3	3	200	90	3.1	1	B7G	P	
64ME	028 470 310 0000	00	226 457 310		6.3	16	250	250		†1.0	AO8	TI	
64ME	020 478 310 0000	00	226 457 310		6.3	2.5	250	250		†1.0	AO8	TI	
64SPT	141 230 870 0000	00	141 230 650		6.3	2.6	200	200	10	7.1	B9A	P	
65	287 130 000 0000	40	265 130 000	G1	6.3	3	200	90	4.5	1	UX5	P	
65ME	410 230 807 0000	00	41* 23* 6*5		6.3		250	250			B9A	TI	
66KU	290 00X 130 0000	00	280 009 130		6.3				30		B8A	RR	
67	284 130 000 0000	00	264 130 000		6.3	9	150		5	1.1	UX5	T	
67PT	281 074 130 0000	00	261 054 130		6.3	7	250	250	36	10	B8A	P	
68	287 130 000 0000	40	265 130 000	G1	6.3	13.5	150	90	14	1.4	UX5	P	
68A	287 130 000 0000	00	265 130 000	G1	6.3	13.5	150	125	14	1.4	UX5	P	
69	284 413 000 0000	00	264 413 000		6.3	3	200		4.5	1.4	UX6	T	
70	284 413 000 0000	00	264 413 000		6.3	6	200		2.3	0.3	UX6	T	
70A7	128 749 310 0000	00	126 548 310		70				60		AO8	RP	
70A7	128 749 310 0000	00	126 548 310		70	7.5	150	100	40	5.8	AO8	RP	
70L7	128 741 390 0000	00	126 541 380		70				60		AO8	RP	
70L7	128 741 390 0000	00	126 541 380		70	7.5	125	100	40	7.5	AO8	RP	
71	284 300 000 0000	00	264 300 000		5	40	200		20	1.7	UX4	T	
71A	284 300 000 0000	00	264 300 000		5	16.5	90		10	1.4	UX4	T	
75	020 000 300 0000	84	020 000 300	A1/G1	6.3	60	400		82		AO8	T	
75	28X 913 000 0000	40	269 813 000	G1	6.3	2	250		0.9	1.1	UX6	DDT	
76	284 130 000 0000	00	264 130 000		6.3	13.5	250		5	1.4	UX5	T	
77	287 113 000 0000	40	265 113 000	G1	6.3	3	250	100	2.3	1.25	UX6	P	
77E	287 113 000 0000	00	265 113 000	G1	6.3	3	250	100	2.3	1.25	UX6	P	
78	287 113 000 0000	40	265 113 000	G1	6.3	3	250	125	10.5	1.65	UX6	P	
78E	287 113 000 0000	00	265 113 000	G1	6.3	3	200	75	4	1.1	UX6	P	
79	284 183 000 0000	00	264 173 000	G1	6.3		250		10.6		UX6	TT	
80	2X9 300 000 0000	00	298 300 000		5				60		UX4	RR	
80HK	390 200 000 0000	00	380 200 000		5				60		UX4	R	
80M	29X 300 000 0000	00	289 300 000		5				60		UX4	RR	
80S	29X 300 000 0000	00	289 300 000		5				60		UX4	RR	
81	290 300 000 0000	00	280 300 000		7.5				60		UX4	R	
82	29X 300 000 0000	00	289 300 000		2.5				60		UX4	RR	
83	29X 300 000 0000	00	289 300 000		5				120		UX4	RR	
83V	29X 300 000 0000	00	289 300 000		5				60		UX4	RR	
84	29X 130 000 0000	00	289 130 000		6.3				30		UX5	RR	
85	28X 913 000 0000	40	269 813 000	G1	6.3	20	250		8	1.1	UX6	DDT	
85AS	289 300 000 0000	00	268 913 000	G1	6.3	20	250		8	1.1	UX6	DDT	
85S	289 X13 000 0000	40	268 913 000	G1	6.3	10.5	250		3.7	0.7	UX6	DDT	
88	29X 300 000 0000	00	289 300 000		5				60		UX4	RR	
89	287 113 000 0000	40	265 113 000	G1	6.3	10	100	100	9.5	1.2	UX6	P	
90	284 413 000 0000	00	264 413 000		2.5		150		3.5	1.4	UX6	T	
90AC	842 310 000 0000	00	642 310 000		4	12.5	200		40	7.5	B5	T	
92	284 413 000 0000	00	264 413 000		6.3		250		3.5	1.4	UX6	T	
95	287 413 000 0000	00	265 413 000		2.5	20	350	300	42	2.3	UX6	P	
96	291 300 000 0000	00	281 300 000		10				120		UX4	R	
98	29X 130 000 0000	00	289 130 000		6.3				30		UX5	RR	
99V	428 300 000 0000	00	426 300 000		3.3	4.4	90		2.5	0.4	UX4	T	
99X	284 300 000 0000	00	264 300 000		3.3	4.5	90		2.5	0.4	UX4	T	
100AC	842 310 000 0000	00	642 310 000		4	6	200		5	2	B5	T	
104V	842 310 000 0000	00	642 310 000		4	1	100		15	3.5	B5	T	

SPEC.	VALVE TYPE NUMBER	PIN CONNECTIONS				CHARACTERISTICS						BASE	VALVE CLASS
		VCM163 Tester Only		CT160, VT160, VCM Mk 1,2,3,4		Vh	Vg1	Va	Vg2	la	gm mA/V		
		SELECTOR SWITCH	TOP CAP	SELECTOR SWITCH	TOP CAP	V	V	V	V	mA	†Ra MΩ		
	100/200LLID	348 748 220 0000	00	346 547 220		1.4	9.4	150	125	4		AO8	P
	112A	384 200 000 0000	00	364 200 000		5	4.5	90		5	1.5	UX4	T
	114	020 000 300 0000	84	020 000 300	A1/G1	1.4		200		15		AO8	T
	114B	020 000 300 0000	84	020 000 300	A1/G1	1.4	4	200		12	1.1	AO8	T
	116/Pen	007 231 800 0000	40	005 231 600	G1	11.5	1	100	100		7	B7	P
	117DD	741 238 9X1 0000	00	541 236 891		17	2	250	150	5	2.2	B9A	DDP
	117L7	128 479 310 0000	00	126 458 310		117				60		AO8	RP
	117L7	128 479 310 0000	00	126 458 310		117	5.2	100	100	43	5.3	AO8	RP
	117Z3	002 391 000 0000	00	*02 381 000		117				60		B7G	R
	117Z4	020 090 310 0000	00	020 080 310		117				60		AO8	R
	117Z6	02X 190 310 0000	00	029 180 310		117				60		AO8	RR
	120	842 310 000 0000	00	642 310 000		2	12	150		12		B5	T
	120VPA	041 230 700 0000	80	041 230 500	A1	2	1	150	60	2.9	1.1	B7	P
	121VP	280 074 130 0000	00	26* *54 130		12.5	3	200	115	7.2	2.3	B8A	P
	124AC	742 310 000 0000	80	542 310 000	A1	4	1.4	200	60	1.6	0.9	B5	P
	141DDT	284 09X 130 0000	00	264 089 130		14	1.5	200		1.5	1.6	B8A	DDT
	141TH	208 405 130 0000	00	276 454 130		14	2	100		5	2	B8A	TH
	141TH	280 575 130 0000	00	276 454 130		14	2	250	100	8	2.2	B8A	TH
	142BT	028 740 130 0000	00	026 540 130		14	8.5	200	200	29	3.7	AO8	P
	144V	842 310 000 0000	00	642 310 000		4	8	200		6	1.4	B5	T
	154V	842 310 000 0000	00	642 310 000		4	6	200		9	2	B5	T
	163Pen	041 230 807 0000	00	041 23* 6*5		16	10.4	200	175	53	9.5	B9A	P
	164V	842 310 000 0000	00	642 310 000		4	9	200		12	3.4	B5	T
	171DDP	741 238 9X1 0000	00	541 236 891		17	2	200	125	5	2.2	B9A	DDP
	181	284 300 000 0000	00	264 300 000		3	30	200		16	1	UX4	T
	182	284 300 000 0000	00	264 300 000		5	45	200		18	1.5	UX4	T
	182B	284 300 000 0000	00	264 300 000		5	35	250		18	1.5	UX4	T
	183	284 300 000 0000	00	264 300 000		5	60	250		30	1.7	UX4	T
	185BT	020 740 310 0000	80	020 540 310	A1	18	18	200	200	100	9.5	AO8	P
	200	200 300 000 0000	90	200 300 000	D1	2.5				15		UX4	R
	200A	284 300 000 0000	00	264 300 000		5		60		1.5	0.7	UX4	T
	202DDT	90X 231 800 0000	40	809 231 600	G1	20	3	200		3	2.4	B7	DDT
	202MPG	747 231 800 0000	40	545 213 600	G1	20	1.5	200	100	3	1.3	B7	H
	202SPB	081 231 700 0000	40	061 231 500	G1	20	1.5	250	100	4.8	2.8	B7	P
	202STH	840 231 000 0000	50	645 231 700	G1	20	1.5	100		2		B7	TH
	202STH	057 231 800 0000	50	645 231 700	G1	20	1.5	200	60	1		B7	TH
	202VP	041 231 700 0000	80	041 231 500	A1	20	1.5	250	100	4.3	2.2	B7	P
	202VPB	081 231 700 0000	40	061 231 500	G1	20	1.5	250	100	4.3	2.2	B7	P
	203THA	747 231 800 0000	40	545 231 600	G1	20	2	250	100	3.5	0.85	B7	H
	205D	284 300 000 0000	00	264 300 000		3.5	29	400		30	0.95	UX4	T
	205E	284 300 000 0000	00	264 300 000		4.5	22.5	350		29	1.9	UX4	T
	205F	284 300 000 0000	00	264 300 000		4.5	18	300		31	1.7	UX4	T
	210DDT	892 3X0 000 0000	40	682 390 000	G1	2	1	100		2.3	1.1	B5	DDT
	210DET	842 300 000 0000	00	642 300 000		2	4.5	150		3	1.1	B4	T
	210DPT	041 230 700 0000	80	041 230 500	A1	2	1	150	60	2.9	1.3	B7	P
	210HF	842 300 000 0000	00	642 300 000		2	3	150		1.6	1.5	B4	T
	210HPT	842 370 000 0000	00	642 350 000		2	4.5	150	175	7.5	2.5	B5	P
	210LF	842 300 000 0000	00	642 300 000		2	4.5	150		4.8	1.4	B4	T
	210PG	-	-	645 230 700	G1	2		150		1.1		B7	H
	210PG	-	-	645 230 700	G1	2	0	150	40	0.4		B7	H

SPEC.	VALVE TYPE NUMBER	PIN CONNECTIONS				CHARACTERISTICS						BASE	VALVE CLASS
		VCM163 Tester Only		CT160, VT160, VCM Mk 1,2,3,4		Vh	Vg1	Va	Vg2	Ia	gm mA/V		
		SELECTOR SWITCH	TOP CAP	SELECTOR SWITCH	TOP CAP	V	V	V	V	mA	†Ra MΩ		
	210RC	842 300 000 0000	00	642 300 000		2	1.5	150		0.8	0.8	B4	T
	210SPT	041 230 700 0000	80	041 230 500	A1	2	1	150	60	1.9	1.1	B7	P
	210T	284 300 000 0000	00	264 300 000		7.5	32	350		16	1.5	UX4	T
	210VPA	041 230 700 0000	80	041 230 500	A1	2	1	150	60	2.9	1.1	B7	P
	210VPT	041 231 700 0000	80	041 231 500	A1	2	1	150	60	1.9	1.1	B7	P
	213	29X 300 000 0000	00	289 300 000		5				30		UX4	RR
	213Pen	041 230 071 0000	80	*41 23* *51	A1	21	22	200	200	45	6.2	B9A	P
	215P	842 300 000 0000	00	642 300 000		2	7.5	150		10	2.2	B4	T
	215SG	742 300 000 0000	80	542 300 000	A1	2	1	150	60	1.4	1.1	B4	P
	217A	229 300 000 0000	00	228 300 000		10				120		UX4	R
	220	200 300 000 0000	90	200 300 000	D1	2.5				15		UX4	R
	220B	458 230 800 0000	00	446 230 700		2	3	150		5.0	1.5	B7	TT
	220DD	9X2 310 000 0000	00	892 310 000		2						B5	DD
	220HPT	842 370 000 0000	00	642 350 000		2	4.5	150	150	8	2.5	B5	P
	2201PT	040 230 700 0000	80	040 230 500	A1	2	1.5	150	60	2.2	1	B7	P
	2200T	842 370 000 0000	00	642 350 000		2	4.5	150	150	9.5	2.5	B5	P
	220P	842 300 000 0000	00	642 300 000		2	7.5	150		11	2.2	B4	T
	220PA	842 300 000 0000	00	642 300 000		2	4.5	150		10	4	B4	T
	220PT	842 370 000 0000	00	642 350 000		2	9	150	150	19	2.5	B5	P
	220SG	742 300 000 0000	80	542 300 000	A1	2	1	150	60	1.5	1.6	B4	P
	220TH	840 320 000 0000	50	645 230 700	G1	2	3	100		1.7	1.2	B7	TH
	220TH	057 320 800 0000	50	645 230 700	G1	2		150	60	0.6	0.6	B7	TH
	220VS	742 300 000 0000	80	542 300 000	A1	2	1	100	60	2	1.6	B4	P
	220VSG	742 300 000 0000	80	542 300 000	A1	2	1.5	150	60	2.6	1.5	B4	P
	225DU	092 323 X00 0000	00	082 323 900		2				15		B7	RR
	230	842 300 000 0000	00	642 300 000		2	20	150		18	3	B4	T
	230	200 300 000 0000	90	200 300 000	D1	5				30		UX4	R
	230PT	842 370 000 0000	00	642 350 000		2	15	150	150	14	2	B5	P
	230XP	842 300 000 0000	00	642 300 000		2	18	150		22	3	B4	T
	231D	284 300 000 0000	00	264 300 000		3	3	90		2.1	8.4	UX4	T
	240B	548 230 800 0000	00	446 230 700		2	1	150		8.5		B7	TT
	240QP	548 237 800 0000	00	446 253 700		2	12	150	150	6	2.5	B7	PP
	244	284 130 000 0000	00	264 130 000		2	6	150		5.5	1	UX5	T
	244V	842 310 000 0000	00	642 310 000		4	5.5	200		5.5	2.8	B5	T
	245A	287 130 000 0000	40	265 130 000	G1	2	1.5	150	50	4.8	0.6	UX5	P
	246A	387 200 000 0000	40	365 200 000	G1	3.3	1.5	150	40	1.5	0.4	UX4	P
	247A	208 040 030 0000	00	206 040 030		2	4.5	150		3.2	0.9	AO8	T
	248A	028 710 310 0000	40	026 510 310	G1	6.3		150	125	5.5	1.8	AO8	P
	249B	223 300 000 0000	90	223 300 000	D1	2.5				120		UX4	R
	252A	284 300 000 0000	00	264 300 000		5	50	400		60	3.4	UX4	T
	255	289 X43 000 0000	00	268 943 000		2	3	150		0.8	0.6	UX6	DDT
	257	284 730 000 0000	00	264 530 000		5	21.5	100	100	20	1.3	UX5	P
	257A	280 300 000 0000	40	260 300 000	G1	3.1	3	90		2.1	0.5	UX4	T
	259A	287 130 000 0000	40	265 130 000	G1	2	1.5	200	75	5.5	1.4	UX5	P
	259B	287 130 000 0000	40	265 130 000	G1	2	1.2	200	75	5.5	1.4	UX5	P
	262B	281 300 000 0000	40	261 300 000	G1	10	4.5	150		2.8	0.9	UX4	T
	264	284 300 000 0000	00	264 300 000		1.1	9	150		2.5	0.6	UX4	T
	264C	284 300 000 0000	00	264 300 000		1.5	8	100		2.1	0.6	UX4	T
	264E	284 300 000 0000	00	264 300 000		1.4	8	100		2.1	0.6	UX4	T
	271A	284 130 000 0000	00	264 130 000		5	30	400		37.5	2.9	UX5	T

SPEC.	VALVE TYPE NUMBER	PIN CONNECTIONS				CHARACTERISTICS						BASE	VALVE CLASS
		VCM163 Tester Only		CT160, VT160, VCM Mk 1,2,3,4		Vh	Vg1	Va	Vg2	la	gm mA/V		
		SELECTOR SWITCH	TOP CAP	SELECTOR SWITCH	TOP CAP	V	V	V	V	mA	†Ra MΩ		
	272A	284 130 000 0000	00	264 130 000		10	15	150		5.4	0.7	UX5	T
	274A	29X 300 000 0000	00	289 300 000		5				60		UX4	RR
	275A	284 300 000 0000	00	264 300 000		5	4.5	200		47	2.7	UX4	T
	281A	284 730 000 0000	00	264 530 000		5	60	150	75	35	1.5	UX5	P
	283A	287 130 000 0000	40	265 130 000	G1	2	1.5	200	75	5.9	1.3	UX5	P
	285	287 130 000 0000	40	265 130 000	G1	2	12	200	150	8.8	0.9	UX5	P
	286A	287 113 000 0000	40	265 113 000	G1	2	1.5	200	75	6.2	1.2	UX6	P
	290A	287 113 000 0000	40	265 113 000	G1	10	1.5	200	75	5.4	1.2	UX6	P
	291A	287 841 300 0000	40	275 641 300	G1	10	3	200		4.5		B7	H
	291A	287 841 300 0000	40	275 641 300	G1	10	7.5	200	75	3.1		B7	H
	292A	289 X13 000 0000	40	268 913 000	G1	10	6	150		2.1	0.6	UX6	DDT
	293A	287 413 000 0000	00	265 413 000		10	18	200	200	14.5	1	UX6	P
	300A	284 300 000 0000	00	364 200 000		5	97	400		80	1.3	UX4	T
	302	847 231 800 0000	50	645 231 700	G1	30	2	100		1.5		B7	TH
	302	057 231 800 0000	50	645 231 700	G1	30	2	250	100	3.5	0.9	B7	TH
	303A	289 X43 000 0000	00	268 943 000		2	6	150		2	0.6	UX6	DDT
	304AC	742 310 000 0000	80	542 310 000	A1	4	2	200	100	3	1.9	B5	P
	309A	287 413 000 0000	00	265 413 000		10	1.5	200	75	4.3	1.1	UX6	P
	310A	287 113 000 0000	40	265 113 000	G1	10	3	150	150	5.5	1.8	UX6	P
	311A	287 130 000 0000	40	235 130 000	G1	10	15	150	150	30	2.8	UX5	P
	311SU	290 000 130 0000	00	28* *** 130		31		225		100		B8A	R
	324A	200 300 000 0000	90	200 300 000	D1	5				5		UX4	R
	328A	287 113 000 0000	40	265 113 000	G1	7.5	3	150	150	5.5	1.8	UX6	P
	329A	287 130 000 0000	40	265 130 000	G1	7.5	15	150	150	37.5	3.3	UX5	P
	332Pen	028 740 310 0000	00	026 540 310		33	8.5	200	200	45	8	AO8	P
	336A	287 413 000 0000	00	265 413 000		10	14	250	250	30	4.2	UX6	P
	337A	287 113 000 0000	40	265 113 000	G1	10	3	150	150	6.3	1.6	UX6	P
	345A	29X 130 000 0000	00	289 130 000		6.3				60		UX5	RR
	347A	020 800 310 0000	40	020 600 310	G1	6.3	4.6	150		2.8	0.9	AO8	T
	349A	028 740 310 0000	00	026 540 310		6.3	14	250	250	30	4.2	AO8	P
	350B	028 740 310 0000	00	026 540 310		6.3	20	400	250	85	6.2	AO8	P
	351A	029 0X0 310 0000	00	028 090 310		6.3				120		AO8	RR
	352A	289 X13 000 0000	40	268 913 000	G1	10	6	100		2.1	0.6	UX6	DDT
	354V	842 310 000 0000	00	642 310 000		4	4.5	250		6.5	3.6	B5	T
	361A	243 780 000 0000	00	243 560 000		1.4		50	40	0.4	0.6	UX5	P
	362A	243 780 000 0000	00	243 560 000		1.4		50	50	1.3	0.5	UX5	P
	367A	080 724 310 0000	00	060 524 310		6.3	20	400	250	85	6.2	AO8	P
	373A	021 477 380 0000	00	021 455 360		2		150	150	2	1.3	AO8	P
	374A	021 407 380 0000	00	021 405 360		3		150	125	18	3	AO8	P
	375A	028 740 310 0000	00	026 540 310		20		40	40	12	4.7	AO8	P
	381A	120 090 300 0000	00	120 080 300		6.3				5		AO8	D
	383A	120 408 030 0000	00	120 406 030		6.3		150		7.5	2.8	AO8	T
	385A	127 040 130 0000	00	125 040 130		6.3		150		7.5	2.5	AO8	P
	387A	127 040 130 0000	00	125 040 130		6.3		150		5.6	4	AO8	P
	396A	214 808 513 0000	00	214 607 413		6.3	2.2	150		8.2	5.5	B9A	TT
	401A	287 300 000 0000	00	265 300 000		5	9	50		1.5	0.8	UX4	T
	402	284 300 000 0000	00	264 300 000		3	40	200		10	1	UX4	T
	402-0T	007 231 800 0000	40	005 231 600	G1	40	12	250	250	32	7	B7	P
	402	000 231 800 0000	40	000 231 600	G1	4	15	200		27	5.5	B7	T
	402Pen	007 231 800 0000	40	005 231 600	G1	40	6.7	200	200	40	7	B7	P
	402PenA	007 231 800 0000	40	005 231 600	G1	40	9	150	150	56	8	B7	P



SPEC.	VALVE TYPE NUMBER	PIN CONNECTIONS				CHARACTERISTICS						BASE	VALVE CLASS
		VCM163 Tester Only		CT160, VT160, VCM Mk 1,2,3,4		Vh	Vg1	Va	Vg2	Ia	gm mA/V		
		SELECTOR SWITCH	TOP CAP	SELECTOR SWITCH	TOP CAP	V	V	V	V	mA	†Ra MΩ		
403A	413 287 100 0000	00		413 265 100		6.3	2.3	150	150	7	4.4	B7G	P
403B	412 387 100 0000	00		412 365 100		6.3		200	125	7.7	5.1	B7G	P
404A	402 108 073 0000	00		402 106 053		6.3		150	150	13.5	12.5	B9A	P
405BU	9X2 300 000 0000	00		892 300 000		4				15		B4	RR
406	842 300 000 0000	00		642 300 000		4		150		5.5	0.5	B4	T
407A	214 838 512 0000	00		214 637 412		20	2	150		8.2	5.5	B9A	TT
408A	412 387 100 0000	00		412 365 100		20	2	150	125	7.5	5	B7G	P
408BU	9X2 300 000 0000	00		892 300 000		4				15		B4	RR
409A	410 087 100 0000	00		410 065 100		6.3		150	125	5.2	3.2	B7G	P
410HF	842 300 000 0000	00		642 300 000		4	2.5	200		0.2	0.2	B4	T
410P	842 300 000 0000	00		642 300 000		4	16	250		12	1.8	B4	T
410PT	482 370 000 0000	00		462 350 000		4	1	100	150		2.5	B5	P
410RC	842 300 000 0000	00		642 300 000		4	2.5	200		0.2	0.2	B4	T
410SG	742 300 000 0000	80		542 300 000	A1	4	1	200	100	4.5	0.9	B4	P
412BU	9X2 300 000 0000	00		892 300 000		4				30		B4	RR
412SU	902 300 000 0000	00		802 300 000		4				60		B4	R
415PT	842 370 000 0000	00		642 350 000		4	25	300	200	20	1.7	B5	P
415SP	842 300 000 0000	00		642 300 000		4	18	150		11	1.6	B4	T
417A	802 441 443 0000	00		602 441 443		6.3	1.5	150		25	25	B9A	T
420T	047 231 800 0000	00		045 231 600		4	4.4	250	250	40	10.5	B7	P
425PT	842 370 000 0000	00		642 350 000		4	17	250	150	12	1.3	B5	P
431U	9X2 300 000 0000	00		892 300 000		4				60		B4	RR
435A	402 108 073 0000	00		402 106 053		6.3	10	200	150	13	16.3	B9A	P
436A	211 403 708 0000	00		211 403 506		6.3	1.4	200	150	23	32	B9A	P
437A	304 002 118 0000	00		304 002 116		6.3	10	150		40		B9A	T
441U	9X2 300 000 0000	00		892 300 000		4				60		B4	RR
446A/B	021 000 310 0000	84		021 000 310	A1/G1	6.3	3	250		15	4.5	AO8	T
450	842 300 000 0000	00		642 300 000		4	55	250		50	3.5	B4	T
450	284 300 000 0000	00		264 300 000		7.5		400		55	2.1	UX4	T
450AC	742 310 000 0000	80		542 310 000	A1	4		200	100	3.5	3	B5	P
451	9X2 300 000 0000	00		892 300 000		1.8			16		650	B4	RR
451PT	280 074 130 0000	00		26* *54 130		45	9	200	200	54.5	9.5	B8A	P
451U	923 X00 000 0000	00		823 900 000		4				120		B4	RR
460BU	9X2 300 000 0000	00		892 300 000		4				60		B4	RR
482A	284 300 000 0000	00		264 300 000		5	45	200		18	1.5	UX4	T
482B	284 300 000 0000	00		264 300 000		5	35	250		18	1.5	UX4	T
483	842 310 000 0000	00		264 300 000		5	60	250		30	1.7	UX4	T
484V	842 310 000 0000	00		642 310 000		4	2.5	200		0.2	1.2	B5	T
485	284 130 000 0000	00		264 130 000		3	9	200		5.8	1.4	UX5	T
486	028 040 300 0000	00		026 040 300		3	3	90		3	0.6	AO8	T
500	9X2 300 000 0000	00		892 300 000		4				30		B4	RR
501	873 420 000 0000	00		653 420 000		1.4	0	40	40	1	0.8	B5A	P
502	873 420 000 0000	00		653 420 000		1.2	1.2	40	40	8.6	0.5	B5A	P
503	873 420 000 0000	00		653 420 000		1.2	2	40	40	0.8	0.5	B5A	P
505	873 420 000 0000	00		653 420 000		0.6	0	40	30	0.1	0.1	B5A	P
506	9X2 300 000 0000	00		892 300 000		4				30		B4	RR
506AX	873 420 000 0000	00		653 420 000		1.2	4.5	40	40	1.2	0.5	B5A	P
506BU	9X2 300 000 0000	00		892 300 000		4				30		B4	RR
506K	9X2 300 000 0000	00		892 300 000		2	2			30		B4	RR
507AX	287 438 200 0000	00		265 436 200		1.2		40	40	0.9	0.5	B7G	P

SPEC.	VALVE TYPE NUMBER	PIN CONNECTIONS				CHARACTERISTICS						BASE	VALVE CLASS
		VCM163 Tester Only		CT160, VT160, VCM Mk 1,2,3,4		Vh	Vg1	Va	Vg2	Ia	gm mA/V		
		SELECTOR SWITCH	TOP CAP	SELECTOR SWITCH	TOP CAP	V	V	V	V	mA	†Ra MΩ		
509	9X2 300 000 0000	00		892 300 000		2				60		B4	RR
509AX	834 200 000 0000	00		634 200 000		0.6	2	40		0.1	0.1	B5A	T
511D	9X2 300 000 0000	00		892 300 000		4				60		B4	RR
512AX	873 420 000 0000	00		653 420 000		0.6	0.6	20	20	0.1	0.1	B5A	P
515BX	834 200 000 0000	00		634 200 000		0.6		40		0.1	0.1	B5A	T
516AX	803 420 000 0000	00		603 420 000		0.6	0.6	22.5		0.1	0.2	B5A	T
518AX	873 420 000 0000	00		653 420 000		1.2	2	40	40	0.8	0.5	B5A	P
520AX	873 420 000 0000	00		653 420 000		0.6	2.5	40	40	0.2	0.1	B5A	P
521AX	873 420 000 0000	00		653 420 000		1.2	3	20	20	0.8	0.4	B5A	P
522AX	873 420 000 0000	00		653 420 000		1.2	0	20	20	0.3	0.4	B5A	P
523AX	873 420 000 0000	00		653 420 000		1.2	1.2	20	20	0.3	0.3	B5A	P
524AX	873 420 000 0000	00		653 420 000		1.2	1.7	12	12	0.4	0.3	B5A	P
525AX	873 420 000 0000	00		653 420 000		1.2	1.2	20	20	0.2	0.3	B5A	P
526AX	873 420 000 0000	00		653 420 000		1.2	1.5	20	20	0.4	0.4	B5A	P
527AX	873 420 000 0000	00		653 420 000		1.2	0	20	20	0.1	0.2	B5A	P
528AX	873 420 000 0000	00		653 420 000		1.2	0	20	20	0.3	0.4	B5A	P
529AX	873 420 000 0000	00		653 420 000		1.2	1.2	12	12	0.3	0.3	B5A	P
532DX	873 420 000 0000	00		653 420 000		1.2	0	20	20	0.4	0.4	B5A	P
533DX	873 420 000 0000	00		653 420 000		1.2	0	20	20	0.3	0.4	B5A	P
535AX	873 420 000 0000	00		653 420 000		1.2	1.2	15		0.3	0.3	B5A	P
537AX	873 420 000 0000	00		653 420 000		1.2	1.5	20	20	0.4	0.4	B5A	P
538A	851 228 413 0000	00		741 226 413		6.3	2	250		10	5.5	B9A	TT
539DX	873 420 000 0000	00		653 420 000		1.2	1.4	20	20	0.2	0.3	B5A	P
541DX	873 420 000 0000	00		653 420 000		1.2	0	30	30	0.2	0.4	B5A	P
542A	802 304 100 0000	00		602 304 100		6.3	2	250		10	5.5	B7G	T
542DX	873 420 000 0000	00		653 420 000		1.2	2	20	20	0.4	0.3	B5A	P
542DXS	873 420 000 0000	00		653 420 000		1.2	2	20	20	0.4	0.3	B5A	P
543	402 013 080 0000	00		402 013 060		6.3	2.5	200		9.5	3.8	B8D	T
544A	802 384 100 0000	00		602 364 100		6.3	8.5	250		10.5	2.2	B7G	T
544DX	873 420 000 0000	00		653 420 000		1.2	0	30	30	0.1	0.3	B5A	P
546A	902 30X 100 0000	00		802 309 100		6.3				30		B7G	RR
546DX	873 420 000 0000	00		653 420 000		1.2	0	20	20	0.3	0.4	B5A	P
547A	120 417 380 0000	00		120 415 360		6.3	3	300	150	30	11	AO8	P
547DX	873 420 000 0000	00		653 420 000		1.2	0	40	30	0.2	0.4	B5A	P
548A	982 344 000 0000	00		762 344 100		6.3	0.8	100		8.5	5.3	B7G	TT
548A	982 344 000 0000	00		762 344 100		6.3	3	150		5	4.5	B7G	TT
548DX	873 420 000 0000	00		653 420 000		1.2	1.4	20	20	0.2	0.3	B5A	P
549A	1X2 310 900 0000	00		192 310 800		6.3						B7G	DD
550A	581 481 230 0000	00		471 461 230		6.3	2	250		2.3	1.6	AO8	TT
553AXA	872 430 000 0000	00		652 430 000		1.2	0	20	20	0.4	0.5	B5A	P
559	021 010 030 0000	90		021 010 030	D1	6.3				27		AO8	R
568AX	803 420 000 0000	00		603 420 000		1.2	5.5	135		1.9	0.6	B5A	T
569AX	872 430 000 0000	00		652 430 000		1.2		60	60	1.8	1.1	B5A	P
573AX	824 300 000 0000	00		624 300 000		1.2	4	90		11	2	B5A	T
574AX	873 420 000 0000	00		653 420 000		0.6	0.6	20	20	0.1	0.1	B5A	P
578	901 23X 148 0000	00		8†1 239 146		4.7	3	250		1	1.2	B9A	DDDT
605	842 300 000 0000	00		642 300 000		4	6	150		10	1.4	B4	T
608CX	823 410 000 0000	00		623 410 000		6.3	2	150		9	5	B5A	T
612BU	9X2 300 000 0000	00		892 300 000		6.3				30		B4	RR
615	842 300 000 0000	00		642 300 000		4	41	150		4	1.4	B4	T

SPEC.	VALVE TYPE NUMBER	PIN CONNECTIONS				CHARACTERISTICS						BASE	VALVE CLASS
		VCM163 Tester Only		CT160, VT160, VCM Mk 1,2,3,4		Vh	Vg1	Va	Vg2	la	gm mA/V		
		SELECTOR SWITCH	TOP CAP	SELECTOR SWITCH	TOP CAP	V	V	V	V	mA	†Ra MΩ		
619CX	823 410 000 0000	00		623 410 000		6.3	2	250		4	4	B5A	T
620T	842 300 000 0000	00		642 300 000		6.3	99	400		62	2.3	B4	T
635GTX	028 040 310 0000	00		026 040 310		6.3	20	350		20		AO8	T
660	842 300 000 0000	00		642 300 000		6.3	100	400		120	2.3	B4	T
660T	842 300 000 0000	00		642 300 000		6.3	1	100		7.4	7.4	B4	T
680XP	842 300 000 0000	00		642 300 000		6.3	100	400		3.5	1.1	B4	T
713A	021 417 380 0000	00		021 415 360		6.3	2	125		7.5	4	AO8	P
731A	412 387 100 0000	00		412 365 100		6.3	2.3	150	150	7	4.3	B7G	P
801	384 200 000 0000	00		364 200 000		7.5	15	400		60	2.5	UX4	T
802	207 411 300 0000	80		205 411 300	A1	6.3	18	400	250	30	2.2	UX7	P
805	842 300 000 0000	00		642 300 000		6.3	6	150		10	1.4	B4	T
807	274 130 000 0000	80		254 130 000	A1	6.3	12.5	400	250	83	6.5	UX5	P
816	200 300 000 0000	90		300 300 000	D1	2.5				120		UX4	R
825	842 300 000 0000	00		642 300 000		6.3		150		6	1.4	B4	T
825BU	9X2 300 000 0000	00		892 300 000		7.5				60		B4	RR
829B	247 135 200 0000	08		245 134 200	A1/A2	6.3	55	300	250	25	1.9	B7A	PP
829B	247 135 200 0000	80		245 134 200	A1/A2	6.3	55	300	250	25	1.9	B7A	PP
832	247 135 200 0000	80		245 134 200	A1/A2	6.3	60	150	125	30	3.5	B7A	PP
832	247 135 200 0000	08		245 134 200	A1/A2	6.3	60	150	125	30	3.5	B7A	PP
836	200 000 300 0000	90		2** 00* 300	D1	2.5				120		B7G	R
837	207 411 300 0000	00		205 411 300		12.6	40	400	150	45		UX7	P
840	274 130 000 0000	80		254 130 000	A1	2	3	200	75	1	0.4	UX5	P
841	284 300 000 0000	00		264 300 000		7.5	1	100			0.7	UX4	T
842	284 130 000 0000	00		264 130 000		7.5	100	400		25	1.2	UX5	T
843	284 130 000 0000	00		264 130 000		2.5	25	350		25	1.7	UX5	T
864	384 200 000 0000	00		364 200 000		1.1	4.5	90		2.9	0.6	UX4	T
871	200 300 000 0000	90		200 300 000	D1	2.5				120		UX4	R
879	200 300 000 0000	90		200 300 000	D1	2.5				5		UX4	R
884	028 040 310 0000	00		026 040 310		6.3	15	100		22	†4kΩ	AO8	THY
884	028 040 310 0000	00		026 040 310		6.3	35	200		50	†4kΩ	AO8	THY
885	284 130 000 0000	00		264 130 000		2.5	15	100		22	†4kΩ	UX5	THY
885	284 130 000 0000	00		264 130 000		2.5	35	100		50	†4kΩ	UX5	THY
904V	842 310 000 0000	00		642 310 000		4	2	200		2	2	B5	T
950	041 230 700 0000	80		041 230 500	A1	2	16.5	200	150	7	0.9	B7	P
951	287 300 000 0000	40		265 300 000	G1	2	3	200	60	1.7	0.6	UX4	P
952F	299 310 000 0000	00		288 310 000		6.3				2		5AA	D
954	213 174 000 0000	80		213 154 000	A1	6.3	3	250	100	2	1.4	7AA	P
955	284 310 000 0000	00		264 310 000		6.3	7	250		6.3	2.2	5AA	T
956	213 174 000 0000	80		213 154 000	A1	6.3	3	250	100	6.7	1.8	7AA	P
957	322 480 000 0000	00		322 460 000		1.2	5	150		2	0.6	5AA	T
958	384 220 000 0000	00		364 220 000		1.2	7.5	135		3	1.2	5AA	T
958A	322 480 000 0000	00		364 220 000		1.2	20	150				5AA	T
959	322 174 000 0000	80		322 154 000	A1	1.2	3	150	60	1.7	0.6	7AA	P
985	29X 130 000 0000	00		289 130 000		5				30		UX5	RR
986	29X 300 000 0000	00		289 300 000		5				60		UX4	RR
994V	842 310 000 0000	00		642 310 000		4	0.5	100			3.6	B5	T
1002	903 300 000 0000	00		802 300 000		1.8				60		B4	R
1005	009 0X2 030 0000	00		008 092 030		6.3				30		AO8	RR
1006	29X 300 000 0000	00		289 300 000		1.7				120		UX4	RR
1007	009 0X0 230 0000	00		008 090 230		1.0				60		AO8	RR
1012	29X 300 000 0000	00		289 300 000		1.7				120		UX4	RR
1028	202 322 200 0000	90		202 322 200	D1	6.3				60		B7G	R
1103	90X 231 800 0000	40		809 231 600	G1	13	2	250		1.5	1.5	B7	DDT

SPEC.	VALVE TYPE NUMBER	PIN CONNECTIONS				CHARACTERISTICS						BASE	VALVE CLASS
		VCM163 Tester Only		CT160, VT160, VCM Mk 1,2,3,4		Vh	Vg1	Va	Vg2	la	gm mA/V		
		SELECTOR SWITCH	TOP CAP	SELECTOR SWITCH	TOP CAP	V	V	V	V	mA	†Ra MΩ		
1130	9X2 300 000 0000	00		892 300 000		1.8				1.3		B4	DD
1201	428 141 830 0000	00		426 141 630		6.3	3	200		5.5	3	B8B	T
1201	9X2 300 000 0000	00		892 300 000		2.5				30		B4	DD
1203	200 900 130 0000	00		200 800 130		6.3				5		B8B	D
1204	728 141 310 0000	00		526 141 310		6.3	2	250	100	1.7	1.2	B8B	P
1206	287 451 830 0000	00		265 441 730		6.3	2.5	250	100	4.5	2.1	B8B	PP
1216	882 345 100 0000	00		672 344 100		6.3	2.3	100		4.8	3.4	B7G	TT
1217	412 387 100 0000	00		412 365 100		6.3	2	75	75	6.3	2	B7G	H
1221	187 113 000 0000	40		165 113 000	G1	6.3	3	250	100	2	1.2	UX6	P
1222	287 403 100 0000	00		265 403 100		6.3	18	350	250	54	5.2	AO8	P
1223	028 710 310 0000	40		026 510 310	G1	6.3	3	250	100	2	1.2	AO8	P
1229	287 300 000 0000	40		265 300 000	G1	2	3	150	75	1.7	0.6	UX4	P
1230	284 300 000 0000	00		264 300 000		2	9	150		3		UX4	T
1231	287 104 130 0000	00		265 104 130		6.3	30	300	200	13	6.3	B8B	P
1232	287 114 130 0000	00		265 114 130		6.3	2	250	100	6	4.5	B8B	P
1236A	333 992 220 0000	00		333 882 220		2						AO8	D
1238	257 881 430 0000	00		245 671 430		28	3.5	40	30	12.5	3.4	B8B	PP
1247	000 230 000 0000	90		000 230 000	D1	0.6				0.4		B8A	D
1273	287 104 130 0000	00		265 104 130		6.3	3	250	100	2.2	1.5	B8B	P
1274	029 0X0 310 0000	00		028 090 310		6.3				30		AO8	RR
1275	29X 300 000 0000	00		289 300 000		5				120		UX4	RR
1276	284 300 000 0000	00		264 300 000		4.3	45	250		60	5.2	UX4	T
1280	287 104 130 0000	00		265 104 130		12.5	3	250	100	2.2	1.5	B8B	P
1282	287 114 130 0000	00		265 114 130		6.3	2	300	150	10	5.8	B8B	P
1284	287 104 103 0000	00		265 104 130		12.5	3	250	100	9	2	B8B	P
1288	384 250 830 0000	00		364 240 730		1.4		90		5.2	1.8	AO8	TT
1291	284 305 820 0000	00		274 304 620		1.4		90		5.2	1.8	AO8	TT
1292	384 205 830 0000	00		364 204 730		1.4		90		5.2	1.8	AO8	TT
1293	280 084 030 0000	00		260 064 030		1.4	0	90		5.2	1.3	B8B	T
1294	200 900 130 0000	00		200 800 130		1.4				1		AO8	D
1299	387 004 230 0000	00		365 004 230		1.4	4.5	150	90	10.2	2.4	B8B	P
1560	29X 300 000 0000	00		289 300 000		5				60		UX4	RR
1560	9X2 300 000 0000	00		892 300 000		5				60		B4	RR
1561	9X2 300 000 0000	00		892 300 000		4				60		B4	RR
1562	290 300 000 0000	00		280 300 000		7.5				120		UX4	R
1602	284 300 000 0000	00		264 300 000		7.5	23.5	250		10	1.3	UX4	T
1603	287 113 000 0000	40		265 113 000	G1	6.3	3	250	100	2	1.2	UX6	P
1608	284 300 000 0000	00		264 300 000		2.5	90	400		95		UX4	T
1609	384 720 000 0000	00		364 520 000		1.1	1.5	150	75	2.5	0.7	UX5	P
1610	284 730 000 0000	00		264 530 000		2.5	16.5	250	250	31	2.5	UX5	P
1611	028 740 310 0000	00		026 540 310		6.3	16.5	250	250	34	2.5	AO8	P
1612	028 740 310 0000	40		026 540 310	G1	6.3	3	250	100	5.3	1.1	AO8	H
1613	028 740 310 0000	00		026 540 310		6.3	16.5	250	250	34	2.5	AO8	P
1614	028 740 310 0000	00		026 540 310		6.3	18	350	250	54	5.2	AO8	P
1616	200 300 000 0000	90		200 300 000	D1	2.5				120		UX4	R
1619	028 740 310 0000	00		026 540 310		2.5	10	300	250	45	4.5	AO8	P
1620	028 710 310 0000	40		026 510 310	G1	6.3	3	250	100	2	1.2	AO8	P
1621	028 740 310 0000	00		026 540 310		6.3	16.5	250	250	34	3.5	AO8	P
1624	207 401 300 0000	80		205 401 300	A1	2.5	10	300	250	45	4.5	UX7	P
1625	207 401 300 0000	80		205 401 300	A1	12	12.5	400	250	83	6.5	UX7	P

SPEC.	VALVE TYPE NUMBER	PIN CONNECTIONS				CHARACTERISTICS						BASE	VALVE CLASS
		VCM163 Tester Only		CT160, VT160, VCM Mk 1,2,3,4		Vh	Vg1	Va	Vg2	la	gm mA/V		
		SELECTOR SWITCH	TOP CAP	SELECTOR SWITCH	TOP CAP	V	V	V	V	mA	†Ra MΩ		
1626	028 040 310 0000	00		026 040 310		12.5	32	250		20	2.1	AO8	T
1629	028 740 310 0000	00		026 540 310		12.5	8	250	250	0.2	†1.0	AO8	TI
1631	028 740 310 0000	00		026 540 310		12.5	18	350	250	54	5.2	AO8	P
1632	028 740 310 0000	00		026 540 310		12.5	8	200	100	50	9.5	AO8	P
1633	581 481 230 0000	00		471 461 230		25	8	250		11.5	2.6	AO8	TT
1634	085 481 230 0000	00		074 461 230		12.5	2	250		2	1.3	AO8	TT
1635	028 548 310 0000	00		027 446 310		6.3	0	300		3.5	0.9	AO8	TT
1637	028 700 310 0000	40		026 500 310	G1	6.3	18	250	250	32	3.8	AO8	P
1638	02X 190 310 0000	00		029 180 310		6.3						AO8	DD
1639	028 9X0 310 0000	40		026 890 310	G1	6.3	5.5	250		5	2	AO8	DDT
1641	200 300 000 0000	9X		200 300 000	D1/D2	5				120		UX4	RR
1641/RK60	200 300 000 0000	9X		200 300 000	D1/D2	5				50		UX4	RR
1642	218 481 300 0000	50		216 471 300	G1	6.3	16.5	250		8.3	1.4	UX7	TT
1644	514 872 380 0000	00		414 752 360		12.5	9	200	200	13	2.1	AO8	PP
1649	021 417 380 0000	00		021 415 360		6.3	2	300	150	10	9	AO8	P
1654	200 000 300 0000	90	2** 00* 300		D1	1.4						B7G	D
1655	085 481 230 0000	00		074 461 230		6.3	2	250		2	1.3	AO8	TT
1659	289 X13 000 0000	40		268 913 000	G1	2.5	2	250		0.9	1.1	UX6	DDT
1662	384 728 300 0000	00		364 526 300		1.4	8.4	150	90	13.3	1.9	B7G	P
1664	028 X97 310 0000	40		026 985 310	G1	2.5	3	250	125	10	1.3	AO8	DDP
1701	9X2 300 000 0000	00		892 300 000		1.8				120		B4	RR
1801	9X2 300 000 0000	00		892 300 000		4				15		B4	RR
1805	9X2 300 000 0000	00		892 300 000		4				30		B4	RR
1810	003 200 000 0000	90		003 200 000	D1	4				30		B4	R
1815	9X2 300 000 0000	00		892 300 000		4				60		B4	RR
1817	9X2 300 000 0000	00		892 300 000		4				120		B4	RR
1831	9X2 300 000 0000	00		892 300 000		4				30		B4	RR
1832	092 300 000 0000	00		082 300 000		4				120		B4	R
1851	028 710 310 0000	40		026 510 310	G1	6.3	2	300	150	10	9	AO8	P
1852	021 417 380 0000	00		021 415 360		6.3	2	300	150	10	9	AO8	P
1853	021 417 380 0000	00		021 415 360		6.3	3	300	200	12.5	5	AO8	P
1853GT	028 710 310 0000	40		026 510 310	G1	6.3	3	300	200	12.5	5	AO8	P
1861	9X2 300 000 0000	00		892 300 000		4				60		B4	RR
1867	39X 200 000 0000	00		389 200 000		4				60		UX4	RR
1868	023 190 0X0 0000	00		023 180 090		4				60		F8	RR
1875	023 000 000 0000	90		023 000 000	D1	4				5		8SC	R
1876	123 000 090 0000	00		123 000 080		4				5		8SC	R
1877	002 300 000 0000	90		002 300 000	D1	4				3		B4	R
1881	9X2 300 000 0000	00		892 300 000		4				30		B4	RR
1882	023 090 0X0 0000	00		023 080 090		5				60		8SC	RR
1884	120 X09 030 0000	00		120 908 030		2.5				15		AO8	RR
2033	982 344 100 0000	00		762 344 100		6.3	1	100		9.5	6	B7G	TT
2051	028 041 310 0000	00		026 041 310		6.3		100		30	†3kΩ	AO8	THY
2051	028 041 310 0000	00		026 041 310		6.3		250		75	†3kΩ	AO8	THY
2101	284 730 000 0000	00		264 530 000		2	4.5	150	150	8	1.7	UX5	P
2102	289 X73 000 0000	00		268 953 000		2	1	100		2.5	1.3	UX6	DDT
2103	285 748 300 0000	00		274 546 300		2	7.5	150	150	4	1.5	UX7	PP
2151	287 413 000 0000	00		265 413 000		14	31	250	250	47	2.7	UX6	P
2318	9X2 300 000 0000	00		892 300 000		4				30		B4	RR
2506	9X2 300 000 0000	00		892 300 000		4				15		B4	RR
3006	902 300 000 0000	00		802 300 000		4				3		B4	D
3041	872 430 000 0000	00		652 430 000		1.2	1	20	20	0.2	0.3	B5A	P
3074A	205 140 300 0000	80		204 140 300	A1/A2	6.3		300		50	3	UX7	TT
3074A	205 140 300 0000	80		204 140 300	A1/A2	6.3		300		50	3	UX7	TT
3075A	002 300 000 0000	90		002 300 000	D1	2				3		B4	D
3310A	287 113 000 0000	40		265 113 000	G1	10		250	150	5.6	2	UX6	P
3311A	287 113 000 0000	40		265 113 000	G1	10		200	150	33	3	UX6	P
3328A	287 113 000 0000	40		265 113 000	G1	7.5		250	150	5.6	1.9	UX6	P

SPEC.	VALVE TYPE NUMBER	PIN CONNECTIONS				CHARACTERISTICS						BASE	VALVE CLASS
		VCM163 Tester Only		CT160, VT160, VCM Mk 1,2,3,4		Vh	Vg1	Va	Vg2	la	gm mA/V		
		SELECTOR SWITCH	TOP CAP	SELECTOR SWITCH	TOP CAP	V	V	V	V	mA	†Ra MΩ		
	3329A	287 113 000 0000	40	265 113 000	G1	7.5		200	125	31	2.9	UX6	P
	3481	028 710 310 0000	40	026 510 310	G1	6.3	13.5	150	150	5.5	1.8	AO8	P
	3720	384 200 000 0000	00	364 200 000		5	1.5	200		0.2	0.2	UX4	T
	3872	384 200 000 0000	00	364 200 000		2	9	150		3		UX4	T
	3873	387 200 000 0000	40	365 200 000	G1	2	3	150	75	1.5	0.6	UX4	P
	3921	284 300 000 0000	00	264 300 000		2.5	50	250		34	2.1	UX4	T
	3924	287 130 000 0000	40	265 130 000	G1	2.5	3	200	90	4	1	UX5	P
	4019A	284 300 000 0000	00	264 300 000		4		200		9.7	1.3	UX4	T
	4019B	842 300 000 0000	00	642 300 000		4	4	100		7.5	1.2	B4	T
	4020A	284 300 000 0000	00	264 300 000		2	2	150		1.2	0.6	UX4	T
	4020B	842 300 000 0000	00	642 300 000		2	2	150		1.2	0.6	B4	T
	4021A	284 300 000 0000	00	264 300 000		4	10	150		32.5	3	UX4	T
	4021B	842 300 000 0000	00	642 300 000		4	8	150		23	3	B4	T
	4022AR	284 300 000 0000	00	264 300 000		4	6	200		16.2	2.2	UX4	T
	4022B	842 300 000 0000	00	642 300 000		4	6	200		16.2	2.2	B4	T
	4033	284 130 000 0000	00	264 130 000		6.3	20	400		50	9	UX5	T
	4033A	842 310 000 0000	00	642 310 000		6.3	20	400		50	9	B5	T
	4033L	842 310 000 0000	00	642 310 000		6.3	20	400		60	10	B5	T
	4037A	902 300 000 0000	00	802 300 000		4				120		B4	R
	4045A	842 370 000 0000	00	642 350 000		5	70	250	60	43	1.3	B5	P
	4061A	205 411 300 0000	80	205 411 300	A1	6.3	10	400	200	50	2.5	B7	P
	4074A	205 140 300 0000	88	204 140 300	A1/A2	6.3	13	300		15	3	UX7	TT
	4077A	003 200 000 0000	90	003 200 000	D1	5				120		B4	R
	4264A	384 200 000 0000	00	364 200 000		1.5		100			0.5	UX4	T
	4274A	29X 300 000 0000	00	289 300 000		5				120		UX4	RR
	4300A	384 200 000 0000	00	364 200 000		5	90	400		50		UX4	T
	4310A	287 113 000 0000	40	265 113 000	G1	10	5.5	250	150	5.2	2	UX6	P
	4328A	287 113 000 0000	40	265 113 000	G1	7.5	5.5	250	175		2	UX6	T
	4328D	028 710 310 0000	40	026 510 310	G1	7.5	5.5	250	150	6.2	2	AO8	T
	4605	284 130 000 0000	00	264 130 000		1.8	6	220		4		UX5	T
	4606	423 800 000 0000	00	423 600 000		4.5	9	130		8.5	1	UX4	T
	4607	423 800 000 0000	00	423 600 000		2.1	1.6	130		0.7	0.5	UX4	T
	4608	842 310 000 0000	00	642 310 000		4	6	150		11	2.5	B5	T
	4609	423 800 000 0000	00	423 600 000		4.2	5	130		8	2.3	UX4	T
	4610	742 310 000 0000	80	542 310 000	A1	4	1.3	200	100	1.5	0.9	B5	P
	4611	384 200 000 0000	00	364 200 000		6.3	40	200		20	1.7	UX4	T
	4611	842 300 000 0000	00	642 300 000		6.3	40	200		20	1.7	B4	T
	4612	842 300 000 0000	00	642 300 000		4	40	250		40	2.7	B4	T
	4613	842 300 000 0000	00	642 300 000		4	22	250		48	3.5	B4	T
	4614	842 310 000 0000	00	642 310 000		4	16	200		12	1.3	B5	T
	4617	423 800 000 0000	00	423 600 000		4	0.8	130		25	3	UX4	T
	4618	742 310 000 0000	80	542 310 000	A1	4	2	200	100	3	2.2	B5	P
	4619	9X2 300 000 0000	00	892 300 000		4				30		B4	RR
	4623	123 000 000 0000	90	123 000 000	D1	6.3				5		B3G	D
	4630	423 800 000 0000	00	423 600 000		4.2	8.4	180		8.5	1.3	UX4	T
	4631	284 300 000 0000	00	264 300 000		2	1.5	150		0.7		UX4	T
	4635	842 310 000 0000	00	642 310 000		4	16	200		12	9	B5	T
	4636	742 310 000 0000	80	542 310 000		4	2	200	100	3	2.3	B5	P
	4650	842 370 000 0000	00	642 350 000		4	63	300	300	30		B5	P
	4651	023 190 0X0 0000	00	023 180 090		6.3				60		8SC	RR
	4652	9X2 300 000 0000	00	892 300 000		4				60		B4	RR
	4654	411 230 070 0000	80	411 230 050	A1	6.3	14	250	275	72	8.5	8SC	P
	4654K	023 114 700 0000	80	023 114 500	A1	6.3	12.5	250	275	72	8.5	8SC	P
	4654P	411 230 070 0000	80	411 230 050	A1	6.3	14	250	275	72	8.5	8SC	P
	4655	182 300 000 0000	00	462 300 000		4.5				60		B4	RR
	4657	842 310 000 0000	00	642 310 000		4	1.5	200		1	2.2	B5	T

SPEC.	VALVE TYPE NUMBER	PIN CONNECTIONS				CHARACTERISTICS						BASE	VALVE CLASS
		VCM163 Tester Only		CT160, VT160, VCM Mk 1,2,3,4		Vh	Vg1	Va	Vg2	la	gm mA/V		
		SELECTOR SWITCH	TOP CAP	SELECTOR SWITCH	TOP CAP	V	V	V	V	mA	†Ra MΩ		
4670	532 784 780 0000	00		432 564 570		2	8.5	90	90	1		8SC	PP
4671	284 310 000 0000	00		264 310 000		6.3	5	200		4.5	2	5AA	T
4672	713 100 000 0000	84		513 100 000	A1/G1	6.3	3	90	90	1.2	1.1	5AA	P
4673	023 110 780 0000	40		023 110 560	G1	4	2.5	250	200	8	5	B5	P
4675	284 310 000 0000	00		264 310 000		4	5	200		4.5	2	5AA	T
4676	271 310 000 0000	84		251 310 000	A1/G1	4	3	250	100	2	1.4	5AA	P
4677	023 104 780 0000	00		023 104 560		4	4	250	250	0.12	†2.0	8SC	TI
4678	023 104 780 0000	00		023 104 560		6.3	5	250	250	0.1	†2.0	8SC	TI
4679	023 110 560 0000	00		023 110 560		6.3	2.5	250	200	8	5	8SC	P
4682	023 100 780 0000	40		023 100 560	G1	4		375	250	24		8SC	P
4683	023 004 080 0000	00		023 004 060		4		350		43		8SC	T
4684	023 104 780 0000	00		023 104 560		4		400	250	24		8SC	P
4688	023 104 780 0000	00		023 104 560		4		400	275	48		8SC	P
4689	023 740 310 0000	00		026 540 310		6.3		400	275	48		AO8	P
4689	023 104 780 0000	00		023 104 560		6.3		400	275	48		8SC	P
4694	023 104 780 0000	00		023 104 560		6.3	7.5	400	250	24	8	8SC	P
4695	271 310 000 0000	84		251 310 000	A1/G1	6.3	3	250	100	6.7	1.7	5AA	P
4696	023 190 780 0000	40		023 180 560	G1	6.3	2.5	250	150	8	14	F8	DP
4699	023 104 780 0000	00		023 104 560		6.3	12.5	300	300	55	13	8SC	P
5222	402 813 080 0000	00		402 613 060		6.3	1	100		0.7	1.7	B8D	T
5516	237 242 300 0000	80		235 242 300	A1	3	14	400	250	75	4	AO8	P
5556	284 300 000 0000	00		264 300 000		4.5	30	350		9	0.9	UX4	T
5590	412 387 100 0000	00		412 365 100		6.3	4.5	90	90	3.9	2	B7G	P
5591	412 387 100 0000	00		412 365 100		6.3	1.9	200	125	7.7	5	B7G	P
5603	021 417 380 0000	00		021 415 360		6.3	12.5	150	150	50	5.4	AO8	P
5608	412 387 100 0000	00		412 365 100		6.3	12	150	125	7.5	5	B7G	P
5610	812 384 000 0000	00		612 364 000		6.3	1.5	90		17	4	B7G	T
5618	287 134 200 0000	00		265 134 200		3	8	300	75	19	3.5	B7G	P
5635	452 083 810 0000	00		442 *63 710		6.3	0.5	100		4.8		B8B	TT
5636	412 183 710 0000	00		412 163 510		6.3	1.4	100	100	5.3	3.3	B8D	P
5637	402 013 080 0000	00		402 013 060		6.3		100		1.4	2.7	B8B	T
5639	412 183 710 0000	00		412 163 510		6.3	2.6	150	100	21	9	B8D	P
5640	412 183 710 0000	00		412 163 510		6.3	6	100	100	31	5	B8B	P
5641	092 913 090 0000	00		082 813 080		6.3				30		B8D	R
5642	023 000 000 0000	90		023 000 000	D1	1.2				0.25		B3G	D
5643	812 113 410 0000	00		612 113 410		6.3	5	150		37	†3.75Ω	B8D	THY
5643	812 113 410 0000	00		612 113 410		6.3	2.6	300		75	†3.75Ω	B8D	THY
5645	812 430 000 0000	00		612 430 000		6.3	2.8	100		5	2.7	B5B	T
5646	812 430 000 0000	00		612 430 000		6.3	1.1	100		1.4	2.4	B5B	T
5647	391 290 000 0000	00		381 280 000		6.3				5.0		B5A	D
5654	412 387 100 0000	00		412 365 100		6.3	2	150	125	7.5	5	B7G	P
5656	754 231 881 0000	00		544 231 761		6.3	2	150	125	15	5.8	B9A	PP
5659	028 740 310 0000	00		026 540 310		12.5	12.5	250	250	32	3	AO8	P
5660	028 9X7 310 0000	40		026 895 310	G1	12.5	3	250	125	10	1.3	AO8	DDP
5661	021 417 380 0000	00		021 415 360		12.5	0.4	250	100	9.2	2	AO8	P
5670	214 808 513 0000	00		214 607 413		6.3	2	150		8.2	5.5	B9A	TT
5672	873 420 000 0000	00		653 420 000		1.2	6.5	60	60	3.1	0.6	B5A	P
5676	824 300 000 0000	00		624 300 000		1.2	5	150		4	1.6	B5A	T
5677	834 200 000 0000	00		634 200 000		1.2	6	150		1.9	0.6	B5A	T
5678	872 430 000 0000	00		652 430 000		1.2	0	60	60	1.8	1	B5A	P
5679	219 30X 120 0000	00		218 309 120		6.3				5		B8B	RR
5686	141 237 817 0000	00		141 235 615		6.3	12.5	250	250	27	3.1	B9A	P
5687	841 221 538 0000	00		741 221 436		6.3	12.5	250		12.5	5.0	B9A	TT
5690	239 1X2 310 0000	00		238 192 310		6.3				20		AO8	RR
5691	581 481 230 0000	00		471 461 230		6.3	2	250		2.3	1.6	AO8	TT
5692	581 481 230 0000	00		471 461 230		6.3	9	250		6.5	2.2	AO8	TT
5693	021 417 380 0000	00		021 415 360		6.3	3	250	100	3	1.6	AO8	P
5694	128 458 310 0000	00		126 447 310		6.3	6	300		7	3.2	AO8	TT

SPEC.	VALVE TYPE NUMBER	PIN CONNECTIONS				CHARACTERISTICS						BASE	VALVE CLASS
		VCM163 Tester Only		CT160, VT160, VCM Mk 1,2,3,4		Vh	Vg1	Va	Vg2	la	gm mA/V		
		SELECTOR SWITCH	TOP CAP	SELECTOR SWITCH	TOP CAP	V	V	V	V	mA	†Ra MΩ		
5702	872 311 400 0000	00		652 311 400		6.3	2	150	115	7.5	5	B7G	P
5703	823 410 000 0000	00		623 410 000		6.3	2	150		9	5	B5A	T
5704	923 100 000 0000	00		623 100 000		6.3				5		B5A	R
5718	402 013 080 0000	00		402 013 060		6.3	2	100		13	5.5	B8D	T
5719	402 013 080 0000	00		402 013 060		6.3	1.3	150		1.8	2.3	B8B	T
5722	902 209 300 0000	00		802 208 300		3						B7G	D
5725	412 387 100 0000	00		412 365 100		6.3	2	150	125	5.2	3.2	B7G	P
5726	1X2 310 900 0000	00		192 310 800		6.3				5		B7G	RR
5732	028 710 310 0000	40		026 510 310	G1	6.3	3	150	100	8	2.2	AO8	P
5744	823 410 000 0000	00		623 410 000		6.3	2	250		4	4	B5A	T
5749	412 387 100 0000	00		412 365 100		6.3	1	250	100	11	4.4	B7G	P
5750	112 387 400 0000	00		112 365 400		6.3	1.5	250	100	3	.47	B7G	H
5751	851 228 413 0000	00		741 226 413		6.3	3	250		1	1.2	B9A	TT
5755	814 225 183 0000	00		714 224 163		6.3	2	250		2.3	1.6	AO8	TT
5763	801 237 144 0000	00		601 235 144		6.3	7.5	250	250	45	7	B9A	P
5784	872 311 400 0000	00		652 311 400		6.3	2	150	125	5.2	3.2	B7G	P
5785	923 000 000 0000	00		823 000 000		1.2						B3G	D
5797	411 237 800 0000	00		411 235 600		26.5	1	30	30	0.5	1	B8D	P
5798	851 231 480 0000	00		741 231 460		26	0	20		2.3	3.1	B8D	TT
5812	413 387 200 0000	00		413 365 200		3	23	250	250	40	4.1	B7G	P
5814	851 228 413 0000	00		741 226 413		6.3	8.5	250		10.5	2.2	B9A	TT
5824	028 740 310 0000	00		026 540 310		25	22	150	125	61	5	AO8	P
5825	200 300 000 0000	90		200 300 000	D1	1.5				2		UX4	D
5838	029 0X9 310 0000	00		028 090 310		12				30		B8A	RR
5839	029 0X0 310 0000	00		028 090 310		26.5				180		AO8	RR
5840	412 183 710 0000	00		412 163 510		6.3	1.4	100	100	7	5	B8D	P
5842	802 441 443 0000	00		602 441 443		6.3	1.5	150		26	24	B9A	T
5844	882 345 100 0000	00		672 344 100		6.3	2.3	100		4.8	3.4	B7G	TT
5845	902 2X0 300 0000	00		802 290 300		6.3				5		B7G	DD
5847	402 108 073 0000	00		402 106 053		6.3	2	150	150	13	12.5	B9A	P
5851	208 007 340 0000	00		206 005 340		2.5	7.5	150	125	5.5	1.6	B8B	P
5852	029 0X0 310 0000	00		028 090 310		6.3				30		AO8	RR
5854	873 420 000 0000	00		653 420 000		1.2	2	40	40	0.8	0.5	B5A	P
5871	028 740 310 0000	00		026 540 310		6.3	12.5	250	250	45	4.5	AO8	P
5873	284 115 830 0000	00		264 114 730		6.3	3	150		9	2.9	B8B	TT
5875	872 430 000 0000	00		652 430 000		1.2	0	90	90	3.5	2.5	B5A	P
5879	401 230 781 0000	00		401 230 561		6.3	3	250	100	1.8	1	B9A	P
5881	028 740 310 0000	00		026 540 310		6.3	12.5	300	200	48	5.3	AO8	P
5882	029 0X0 310 0000	00		028 090 310		12.6				30		AO8	RR
5894	257 134 200 0000	08		245 134 200	A1/A2	6.3		400	250	30	3.4	B7A	PP
5894	257 134 200 0000	80		245 134 200	A1/A2	6.3		400	250	30	3.4	B7A	PP
5896	912 0X3 100 0000	00		812 093 100		6.3				15		B8B	RR
5897	402 013 080 0000	00		402 013 060		6.3	2.3	150		14	6.5	B8A	T
5898	402 013 080 0000	00		402 013 060		6.3	2	150		1.8	2.3	B8A	T
5899	412 183 710 0000	00		412 163 510		6.3	1.4	100	100	7.2	4.5	B8D	P
5901	412 183 710 0000	00		412 163 510		6.3	1.5	100	100	7.5	5	B8A	P
5902	412 183 710 0000	00		412 163 510		6.3	6.5	100	100	30	4.2	B8A	P
5903	912 0X3 100 0000	00		812 093 100		26				5		B8B	RR
5904	402 013 080 0000	00		402 013 060		26	0	20		3	5	B8D	T
5905	412 183 710 0000	00		412 163 510		26		20	20	2.3	2.8	B8A	P
5906	412 183 710 0000	00		412 163 510		26	1.5	100	100	7.5	5	AO8	P
5907	412 183 710 0000	00		412 163 510		26		20	20	2.7	3	B8A	P
5908	412 183 710 0000	00		412 163 510		26		20	20	2.3	1.7	B8A	P
5910	287 024 300 0000	00		265 *24 300		1.4		90	90	1.6	0.9	B7G	P
5915	412 387 100 0000	00		412 365 100		6.3	0	75	75	6.3	2	B7G	H



SPEC.	VALVE TYPE NUMBER	PIN CONNECTIONS				CHARACTERISTICS						BASE	VALVE CLASS
		VCM163 Tester Only		CT160, VT160, VCM Mk 1,2,3,4		Vh	Vg1	Va	Vg2	la	gm mA/V		
		SELECTOR SWITCH	TOP CAP	SELECTOR SWITCH	TOP CAP	V	V	V	V	mA	†Ra MΩ		
	5916	412 183 710 0000	00	412 163 510		26	1.3	100	100	4.4	1.3	B8A	P
	5920	882 345 100 0000	00	762 344 100		6.3	2.1	100		8.5	6	B7G	TT
	5930	284 300 000 0000	00	264 300 000		2.5	45	250		60	5.2	UX4	T
	5931	020 90X 030 0000	00	020 809 030		5				120		AO8	RP
	5932	028 740 310 0000	00	026 540 310		6.3	14	250	250	72	6	AO8	P
	5933	374 120 000 0000	80	354 120 000	A1	6.3	14	300	250	83	6.5	UX5	P
	5947	222 933 390 0000	00	222 833 380		4.4						AO8	D
	5961	128 741 340 0000	00	126 541 340		6.3		250	100			AO8	H
	5963	851 228 413 0000	00	741 226 413		6.3	2	75		3.5	2	B9A	TT
	5964	882 345 100 0000	00	762 344 100		6.3	1	100		9.5	6	B7G	TT
	5965	851 228 413 0000	00	741 226 413		6.3	1.8	150		8.2	6.5	B9A	TT
	5967	824 335 280 0000	00	624 334 270		1.2		40		3	2	B8B	TT
	5968	240 880 530 0000	00	240 670 430		1.2	0	40		0.7	1.3	B8B	TT
	5969	247 887 530 0000	00	245 675 430		1.2	3	125	40	6	1.7	B8B	PP
	5970	247 887 530 0000	00	245 675 430		1.2		40	40	3	1.8	B8D	PP
	5971	842 430 000 0000	00	642 430 000		1.2	2.5	150		5.6	2.5	B5A	T
	5972	872 430 000 0000	00	652 430 000		1.2	0	60	60	2.5	1.3	B5A	P
	5975	814 230 000 0000	00	614 230 000		6.3	8	200		12	4	B5A	T
	5977	402 013 080 0000	00	402 013 060		6.3	2.7	100		10	4.5	B8B	T
	5987	482 813 080 0000	00	462 613 060		6.3	18	100		9	1.8	B8B	T
	5992	028 740 310 0000	00	026 540 310		6.3	12.5	250	250	45	4.1	AO8	P
	5993	902 010 30X 0000	00	802 010 309		6.3				30		B9A	RR
	5995	902 310 000 0000	00	802 310 000		6.3				30		B5A	R
	5998	481 581 230 0000	00	461 471 230		6.3	14	120		90	14	AO8	TT
	6004	020 000 030 0000	9X	020 000 030	D1/D2	2.5				60		AO8	RR
	6005	412 387 400 0000	00	412 365 400		6.3	12.5	250	250	45	4	B7G	P
	6006	021 417 380 0000	00	021 415 360		6.3	14	250	125	11	4.7	AO8	P
	6007	873 420 000 0000	00	653 420 000		1.2	0.2	20	20	0.4	0.4	B5A	P
	6008	873 420 000 0000	00	653 420 000		0.6	1.1	20	20	0.5	0.1	B5A	P
	6021	842 113 580 0000	00	642 113 470		6.3	1.0	100		6.5	5.4	B8D	TT
	6026	001 230 480 0000	00	001 230 460		6.3	2.6	150		12	5.9	B8B	T
	6028	412 387 100 0000	00	412 365 100		20	1.8	150	125	7.5	5	B7G	P
	6029	824 300 000 0000	00	624 300 000		1.2	4	90		11	2	B5A	T
∅	6030	882 345 100 0000	00	672 344 100		6.3	3	150		5	4.5	B7G	TT
∅	6030	882 345 100 0000	00	672 344 100		6.3	0.8	100		8.5	5.8	B7G	TT
	6042	481 581 230 0000	00	461 471 230		25	8	250		9	2.6	AO8	TT
	6045	882 345 100 0000	00	672 344 100		6.3	0.5	100		9	6.4	B7G	TT
	6046	028 740 310 0000	00	026 540 310		25	8.2	200	125	46	8	AO8	P
	6049	412 183 710 0000	00	412 163 510		6.3	1.5	100	100	7.4	3.5	B8A	P
	6050	824 300 000 0000	00	624 300 000		1.2	5	150		4	1.6	B5A	T
	6051	872 430 000 0000	00	652 430 000		1.2	4	40	40	3	1.2	B5A	P
	6052	912 0X3 100 0000	00	812 093 100		6.3				30		B8B	RR
	6053	912 0X3 100 0000	00	812 093 100		26				5		B8B	DD
	6055	402 013 080 0000	00	402 013 060		26		40			4.7	B8D	T
	6056	412 183 710 0000	00	412 163 510		26		40	40		3	B8D	P
	6057	851 228 413 0000	00	741 226 413		6.3	2	250		1.2	1.6	B9A	TT
	6058	1X2 310 900 0000	00	192 310 800		6.3				9		B7G	DD
	6059	041 230 871 0000	00	041 230 651		6.3	3	250	100	2	1.2	B9A	P
	6060	851 228 413 0000	00	741 226 413		6.3	2	250		10	5.5	B9A	TT
	6061	041 230 871 0000	00	*41 230 651		6.3	13	300	225	34	3.7	B9A	P
	6062	801 237 144 0000	00	601 235 144		6.3	7.5	250	250	45	7	B9A	P

SPEC.	VALVE TYPE NUMBER	PIN CONNECTIONS				CHARACTERISTICS						BASE	VALVE CLASS
		VCM163 Tester Only		CT160, VT160, VCM Mk 1,2,3,4		Vh	Vg1	Va	Vg2	Ia	gm mA/V		
		SELECTOR SWITCH	TOP CAP	SELECTOR SWITCH	TOP CAP	V	V	V	V	mA	†Ra MΩ		
	6063	902 30X 100 0000	00	802 309 100		6.3				30		B7G	RR
ξ	6064	412 381 700 0000	00	412 361 500		6.3	2	250	250	10	7.5	B7G	P
ξ	6064	412 381 700 0000	00	412 361 500		6.3	1.5	200	150	4	6.4	B7G	P
	6065	412 381 700 0000	00	412 361 500		6.3	2.5	250	250	8	2.5	B7G	P
	6066	412 39X 800 0000	00	412 389 600		6.3	3	250		1	1.2	B7G	DDT
	6067	851 228 413 0000	00	741 226 413		6.3	8.5	250		10.5	2.2	B9A	TT
Δ	6068	021 040 370 0000	80	021 040 350		6.3	8	400	150	36	5.3	AO8	P
	6072	851 228 413 0000	00	741 226 413		6.3	4	250		3	1.7	B9A	TT
	6080	501 481 230 0000	00	471 461 230		6.3	30	100		100	7	AO8	TT
	6080	581 401 230 0000	00	471 461 230		6.3	30	100		100	7	AO8	TT
	6082	501 481 230 0000	00	471 461 230		26.5	30	100		100	7	AO8	TT
	6082	581 401 230 0000	00	471 461 230		26.5	30	100		100	7	AO8	TT
	6084	701 238 014 0000	00	501 236 014		6.3	2	250	125	10	9	B9A	P
	6085	841 228 513 0000	00	641 227 413		6.3	5.5	250		6	2.7	B9A	TT
	6086	741 238 001 0000	00	541 236 **1		18	1.8	200	100	8.3	8.2	B9A	P
	6087	020 90X 030 0000	00	020 809 030		6.3				60		AO8	RR
	6088	873 420 000 0000	00	653 420 000		1.2	1.2	40	40	0.7	0.6	B5A	P
	6092	873 420 000 0000	00	653 420 000		1.2	6.5	60	60	2.9	0.7	B5A	P
	6094	472 834 718 0000	00	452 634 516		6.3	12.5	250	250	45	6	B9A	P
	6095	412 387 400 0000	00	412 365 400		6.3	12.5	250	250	45	4.1	B7G	P
	6096	412 387 100 0000	00	412 365 100		6.3	2	150	125	7.5	5	B7G	P
	6097	1X2 310 900 0000	00	192 310 800		6.3				9		B7G	DD
	6098	108 072 430 0000	00	106 052 430		6.3	22.5	250	250	77	5.4	AO8	P
	6099	882 345 100 0000	00	672 344 100		6.3	3	150		5	4.5	B7G	TT
	6099	882 345 100 0000	00	672 344 100		6.3	0.8	100		8.5	5.3	B7G	TT
	6100	802 384 100 0000	00	6*2 364 100		6.3	8.5	250		10.5	2.2	B7G	T
	6101	882 345 100 0000	00	762 344 100		6.3	2	150		9	5.5	B7G	TT
	6106	020 90X 030 0000	00	020 809 030		5				60		AO8	RR
	6110	912 0X3 100 0000	00	812 093 100		6.3				5		B8B	RR
	6111	842 113 580 0000	00	642 113 470		6.3	1.9	100		8.5	5	B8B	TT
	6112	842 113 580 0000	00	642 113 470		6.3	1.4	150		1.7	2.5	AO8	TT
	6113	841 581 230 0000	00	641 471 230		6.3	3	250		3	1.7	AO8	TT
	6118	028 9X0 310 0000	00	026 890 310		6.3	3	250		1.0	1.2	AO8	DDT
	6125	902 394 100 0000	00	6*2 364 100		6.3	8.5	250		10.5	2.2	B7G	T
	6132	041 230 871 0000	00	*41 230 651		6.3	4.5	250	250	40	11	B9A	P
	6134	021 417 380 0000	00	021 415 360		6.3	2	300	150	10	9	AO8	P
	6135	802 384 100 0000	00	6*2 364 100		6.3	8.5	250		10.5	2.2	B7G	T
	6136	412 387 100 0000	00	412 365 100		6.3	1	250	150	10.6	5.2	B7G	P
	6137	021 417 380 0000	00	021 415 360		6.3	3	250	100	9.2	2	AO8	P
	6145	287 104 130 0000	00	265 104 130		6.3		150	100	34	10	B7G	P
	6146	127 141 310 0000	80	125 141 310	A1	6.3	28	200	200	100	7	AO8	P
	6147	208 037 240 0000	00	206 035 240		1.2	7.5	150	125	5.5	1.6	B8B	P
	6149	823 410 000 0000	00	623 410 000		6.3		150		9	5	B5A	T
	6151	823 410 000 0000	00	623 410 000		6.3	0	250		4	4	B5A	T
	6152	814 230 000 0000	00	614 230 000		6.3		200		12	4	B5A	T
	6153T	023 184 780 0000	50	023 164 570	G1	6.3	2	100		16	5	8SC	TH
	6153T	023 184 780 0000	50	023 164 570	G1	6.3	2	250	100	12	3.5	8SC	TH
	6156	412 380 700 0000	00	412 360 500		6.3	13.5	250	250	16	2.6	B7G	P
	6157	001 230 000 0000	90	**1 23* ***	D1	6.3				120		B9A	R
	6158	851 228 413 0000	00	741 226 413		6.3	4.6	250		6	2.3	B9A	TT
	6159	127 141 310 0000	80	125 141 310	A1	26	30	200	200	100	7	AO8	P

SPEC.	VALVE TYPE NUMBER	PIN CONNECTIONS				CHARACTERISTICS						BASE	VALVE CLASS
		VCM163 Tester Only		CT160, VT160, VCM Mk 1,2,3,4		Vh	Vg1	Va	Vg2	Ia	gm mA/V		
		SELECTOR SWITCH	TOP CAP	SELECTOR SWITCH	TOP CAP	V	V	V	V	mA	†Ra MΩ		
6169	842 113 840 0000	00		642 113 640		6.3	1	200		11	6.5	AO8	T
6180	481 581 230 0000	00		461 471 230		6.3	8	250		9	2.6	AO8	TT
6186	412 387 100 0000	00		412 365 100		6.3	1.4	250	150	7	5	B7G	P
6187	412 387 100 0000	00		412 365 100		6.3	2	150	125	5.2	3.2	B7G	P
6188	481 581 230 0000	00		461 471 230		6.3	2	250		2.3	1.6	AO8	TT
6189	841 228 513 0000	00		641 227 413		6.3	8.5	250		10.5	2.2	B9A	TT
6197	147 238 174 0000	00		145 236 154		6.3	3	250	150	30	11	B9A	P
6201	851 228 413 0000	00		741 226 413		6.3		250		10	5.5	B9A	TT
6202	902 30X 100 0000	00		802 309 100		6.3				60		B7G	RR
6203	900 230 10X 0000	00		800 230 109		6.3				70		B9A	RR
6205	412 183 710 0000	00		412 163 510		6.3	4	100	100	7.5	5	B8D	P
6206	412 183 710 0000	00		412 163 510		6.3	1.3	100	100	7.5	5	B8A	P
6211	851 228 413 0000	00		741 226 413		6.3	1.2	100		4.6	3.6	B9A	TT
6216	841 238 710 0000	00		641 236 510		6.3	6	200	100	47	8.8	B9A	P
6222	402 813 090 0000	00		402 613 080		6.3	1	100		0.7	1.7	B8D	T
6227	041 230 871 0000	00		041 230 651		6.3	5.2	200	200	30	9	B9A	P
6245	872 311 400 0000	00		652 311 400		6.3	0	150	150	7.5	5.0	B7G	P
6247	442 813 000 0000	80		442 613 000	A1	6.3	3	200		4	3	B7G	T
6252	257 134 200 0000	88		245 134 200	A1/A2	6.3	17	400	200	20	6.5	B7A	PP
6265	412 387 100 0000	00		412 365 100		6.3	1	250	150	9	4	B7G	P
6267	701 238 014 0000	00		501 236 014		6.3	1.0	250	100	3.0	1.8	B9A	P
6281	873 420 000 0000	00		653 420 000		6.3	0.6	20	20			B5A	P
6286	824 300 000 0000	00		624 300 000		1.2	2	60		6	2.1	B5A	T
6287	178 238 748 0000	00		156 236 546		6.3	12.5	250	250	48	4.1	B9A	P
6293	127 141 300 0000	80		125 141 300	A1	6.3		200	200	100	7.3	AO8	P
6302	287 113 000 0000	40		265 113 000	G1	6.3	2.2	300	150	11	9	UX6	P
6305	112 311 100 0000	90		112 311 100	D1	4				5		B7G	R
6325	109 0X0 230 0000	00		108 090 230		6.3				60		AO8	RR
6327	121 040 370 0000	00		121 040 350		6.3	22.5	250	250	120	8	AO8	P
6336A	581 481 230 0000	00		461 461 230		6.3	55	150		80	3	AO8	TT
6350	814 228 153 0000	00		614 227 143		6.3	5	150		11	4.6	B9A	TT
6351	141 321 877 0000	00		141 321 655		6.3	2	350	250	12.5	11.5	B9A	P
6352	200 392 X30 0000	00		2** 382 930		1.5						B8A	D
6355	782 738 100 0000	00		562 536 100		6.3	15	250	150			B7G	TI
6360	514 228 783 0000	00		414 226 573		6.3	15	200	200	30	3.3	B9A	PP
6374	001 230 009 0000	90		**1 23* **8	D1	6.3				120		B9A	R
6375	400 230 080 0000	00		400 230 060		1.2	4.5	150		12.0	3.4	B8D	T
6384	108 072 430 0000	00		106 052 430		6.3	22	250	250	77	5.5	AO8	P
6385	214 808 513 0000	00		214 607 413		6.3	2.1	150		82	5.5	B9A	TT
6386	214 808 513 0000	00		214 607 413		6.3	2	100		9.6	4	B9A	TT
6394	481 581 230 0000	00		461 471 230		26.5	45	150		100	11	AO8	TT
6397Spec	208 037 240 0000	00		206 035 240		1.2		150	150	9	2.3	B8D	P
6414	841 228 513 0000	00		641 227 413		6.3	2	200		8	5.5	B9A	TT
6417	801 237 144 0000	00		601 235 144		12.5	7.5	250	250	45	7	B9A	P
6418	872 430 000 0000	00		652 430 000		1.2	1.2	20	20	0.2	0.3	B5A	P
6419	872 430 000 0000	00		652 430 000		0.6	0.6	15	15	0.06	0.1	B5A	P
6443	001 230 000 0000	90		**1 23* ***	D1	6.3				120		B9A	R
6463	814 228 153 0000	00		614 227 143		6.3	10	250		14.5	5.2	B9A	TT
6485	412 387 100 0000	00		412 365 100		6.3	1.6	300	150	10	9	B7G	P
6486/A	410 283 711 0000	00		410 263 511		6.3	2	150	125	3.5	3.2	B9A	P

SPEC.	VALVE TYPE NUMBER	PIN CONNECTIONS				CHARACTERISTICS						BASE	VALVE CLASS
		VCM163 Tester Only		CT160, VT160, VCM Mk 1,2,3,4		Vh	Vg1	Va	Vg2	Ia	gm mA/V		
		SELECTOR SWITCH	TOP CAP	SELECTOR SWITCH	TOP CAP	V	V	V	V	mA	†Ra MΩ		
	6488	412 873 180 0000	00	412 653 160		6.3	2.0	100	100	7.5	5.0	B8D	P
	6489	281 380 000 0000	00	261 360 000		6.3		100		8		Sm5	T
	6516	412 380 700 0000	00	412 360 500		6.3	13.5	250	250	16.0	2.6	B7G	P
	6519	873 420 000 0000	00	653 420 000		1.2	0	22.5	22.5	0.4	0.4	B5A	P
	6520	481 581 230 0000	00	461 471 230		6.3	60	150		50	7	AO8	TT
	6526	872 430 000 0000	00	652 430 000		1.2	6	100	100	6.5	1.9	B5A	P
Δ	6528	501 481 230 0000	00	471 461 230		6.3	20	200				AO8	TT
Δ	6528	581 401 230 0000	00	471 461 230		6.3	20	200				AO8	TT
	6533	844 812 380 0000	00	644 612 360		6.3	1.3	150		0.9	1.7	B8D	T
	6535	882 345 100 0000	00	672 344 100		6.3	0.8	100		8.5	5.3	B7G	TT
	6540	412 387 000 0000	00	412 365 000		6.3	2	125	125	7.5	5	B7G	P
	6542	742 135 700 0000	88	542 134 500	A1/A2	6.3	2	200	200	50	4.5	B7A	PP
	6550	028 740 310 0000	00	026 540 310		6.3	16.5	400	225	87	9	AO8	P
	6582A	410 283 711 0000	00	410 263 511		6.3	1.8	120	120	7.5	4.5	B9A	P
	6611	872 430 000 0000	00	652 430 000		1.2	0	40	40	1	1	B5A	P
	6612	872 430 000 0000	00	652 430 000		1.2	0	40	40	3	3	B5A	P
	6660	412 387 100 0000	00	412 365 100		6.3	1.1	250	100	11	4.4	B7G	P
	6661	412 387 100 0000	00	412 365 100		6.3	1.0	250	150	7.4	4.6	B7G	P
	6662	412 387 100 0000	00	412 365 100		6.3	1.0	250	100	9.2	3.6	B7G	P
	6663	192 310 X00 0000	00	182 310 900		6.3				9		B7G	DD
	6664	412 39X 800 0000	00	412 389 600		6.3	12	250		10	5.5	B7G	DDT
	6669	412 387 400 0000	00	412 365 400		6.3	12.5	250	250	47	4.1	AO8	P
	6676	412 387 100 0000	00	412 365 100		6.3	56	150	150	13	8	B7G	P
	6677	147 238 174 0000	00	145 236 154		6.3	3	250	150	30	11	B9A	P
	6678	857 238 114 0000	00	645 237 114		6.3	1.6	150		18	8.5	B9A	TP
	6678	857 238 114 0000	00	645 237 114		6.3	0.9	250	100	10	5.2	B9A	TP
	6679	841 228 513 0000	00	641 227 413		6.3	2	250		10	5.5	B9A	TT
	6680	841 228 513 0000	00	641 227 413		6.3	8.5	250		10.5	2.2	B9A	TT
	6681	841 228 513 0000	00	641 227 413		6.3	2	250		1.2	1.6	B9A	TT
	6686	041 230 871 0000	00	041 230 651		6.3	2.5	200	200	20	11	B9A	P
	6687	412 387 100 0000	00	412 365 100		6.3	5	150	75	0.5	0.6	B7G	H
	6688	141 230 817 0000	00	141 23* 615		6.3	1	200	150	13.5	16.5	B9A	P
	6689	741 238 001 0000	00	541 236 **1		6.3	1.7	200	125	10	9	B9A	P
	6690	852 183 410 0000	00	742 163 410		6.3	0.8	100		8	4.8	B8A	TT
	6697	841 228 513 0000	00	641 227 413		6.3	8.5	250		10	2.0	B9A	TT
	6754	901 023 10X 0000	00	801 023 109		6.3				30		B9A	RR
	6760	841 238 710 0000	00	641 236 510		18	7.5	150	125	70	12	B9A	P
	6761	841 238 710 0000	00	641 236 510		6.3	7.5	150	125	70	13	B9A	P
	6788	412 183 710 0000	00	412 163 510		6.3	1.4	100	100	0.8	1.1	B8A	P
	6814	401 013 080 0000	00	402 013 060		6.3	1.5	100		10	6	B8A	T
	6829	841 228 513 0000	00	641 227 413		6.3	2.2	150		10.7	8.1	B9A	TT
	6832	842 113 580 0000	00	642 113 470		6.3	2.4	100		0.7	1	B8D	TT
	6840	814 228 143 0000	00	614 227 143		6.3	8.7	250		14	5.9	B9A	TT
	6845	402 387 100 0000	00	402 365 100		6.3	2	300	150	10	9	B7G	P
	6850	752 134 700 0000	88	542 134 500	A1/A2	12		200	200	50	4.5	B7A	PP
	6851	841 228 513 0000	00	641 227 413		6.3	3.1	250		1	1.2	B9A	TT
	6853	030 90X 020 0000	00	030 809 090		5				60		AO8	RR
	6854	214 808 513 0000	00	214 607 413		6.3	19.6	150		8.2	5.2	B9A	TT
	6870	141 223 871 0000	00	141 223 651		6.3	3.5	250	250	25	8.5	B9A	P
	6872	721 413 100 0000	80	521 413 100	A1	6.3	1	400	100	3.5	2.2	B7G	P
	6877	402 834 018 0000	00	402 634 016		6.3	12	100		75	6.3	B9A	T
	6883	127 141 130 0000	80	125 141 130	A1	12	30	200	200	100	7	B9A	P

SPEC.	VALVE TYPE NUMBER	PIN CONNECTIONS				CHARACTERISTICS						BASE	VALVE CLASS
		VCM163 Tester Only		CT160, VT160, VCM Mk 1,2,3,4		Vh	Vg1	Va	Vg2	la	gm mA/V		
		SELECTOR SWITCH	TOP CAP	SELECTOR SWITCH	TOP CAP	V	V	V	V	mA	†Ra MΩ		
	6887	192 310 X00 0000	00	182 310 900		6.3				10		B7G	DD
	6888	021 417 380 0000	00	021 415 350		6.3		150	90	38		AO8	P
	6889	200 073 420 0000	00	200 053 420	A1	6.3	22.5	250	250	77	5.4	AO8	P
	6900	851 221 438 0000	00	741 221 436		6.3	2	150		36	11.5	B9A	TT
	6907	247 135 200 0000	08	245 134 200	A1/A2	6.3	50	400	250	100		B7A	PP
	6907	247 135 200 0000	80	245 134 200	A1/A2	6.3	50	400	250	100		B7A	PP
	6913	851 228 413 0000	00	741 226 413		6.3	5	150		11	4.6	B9A	TT
	6919	192 310 X00 0000	00	182 310 900		6.3				5		B7G	RR
	6922	841 238 510 0000	00	641 237 510		6.3	1.2	90		15	12.5	B9A	TT
∅	6927	882 345 100 0000	00	672 344 100		6.3	3	150		5	4.5	B7G	TT
∅	6927	882 345 100 0000	00	672 344 100		6.3	0.8	100		8.5	5.8	B7G	TT
	6928	412 387 400 0000	00	412 365 400		6.3	12.5	250	250	45	4.1	B7G	P
	6939	415 228 783 0000	00	414 226 573		6.3	5	250	200	25	10.5	B9A	PP
	6943	412 183 710 0000	00	412 163 510		6.3	1.2	100	100	8	3.6	B8D	P
	6944	412 183 710 0000	00	412 163 510		6.3	1.05	100	100	7	3.2	B8D	P
	6945	412 183 710 0000	00	412 163 510		6.3	6.7	100	100	25	3.5	B8D	P
	6946	402 013 080 0000	00	402 013 060		6.3	2.4	100		9	3.8	B8D	T
	6947	842 113 580 0000	00	642 113 470		6.3	1.75	150		6.5	4	B8D	TT
	6948	842 113 580 0000	00	642 113 470		6.3	1.2	100		0.8	1.6	B8D	TT
	6954	412 387 100 0000	00	412 365 100		6.3	1	150	150	5.9	2	B7G	P
	6955	841 228 513 0000	00	641 227 413		6.3	8.5	250		11.5	2.3	B9A	TT
	6968	402 387 100 0000	00	402 365 100		6.3	2	150	125	7.5	5	B7G	P
	6973	704 234 178 0000	00	504 234 156		6.3	15	250	250	46	4.8	B9A	P
	7000	028 710 310 0000	40	026 510 310	G1	6.3	3	250	100	2	1.2	AO8	P
	7025	851 228 413 0000	00	741 226 413		6.3	2	250		1.2	1.6	B9A	TT
	7027(A)	728 744 310 0000	00	526 544 310		6.3	14	250	250	72	6	B8A	P
	7032	412 387 100 0000	00	412 365 100		6.3	2	250	100	4.5	1.8	B7G	H
	7036	412 387 100 0000	00	412 365 100		6.3	0	75	75	6.3	2	B7G	H
	7044	841 221 538 0000	00	641 221 437		6.3	2	150		36	10	B9A	TT
	7051	857 238 114 0000	00	645 237 114		6.3	1.0	150		18	8.5	B9A	TP
	7051	857 238 114 0000	00	645 237 114		6.3	1.0	200	100	10	5	B9A	TP
	7054	141 230 871 0000	00	141 23* 651		13.5	2.7	250	150	19	11.5	B9A	P
	7055	192 310 X00 0000	00	182 310 900		13.5				5		B7G	RR
	7056	412 387 100 0000	00	412 365 100		13.5	2.2	200	150	9.5	6.2	B7G	P
	7057	841 238 510 0000	00	641 237 410		13.5	2.2	150		10	6.8	B9A	TT
	7058	841 238 510 0000	00	641 237 410		13.5	2	250		1.2	1.6	B9A	TT
	7059	857 238 114 0000	00	645 237 114		13.5	1	150		18	8.5	B9A	TP
	7059	857 238 114 0000	00	645 237 114		13.5	0.9	250	100	10	5.2	B9A	TP
	7060	841 238 751 0000	00	641 237 541		13.5	1.5	150		9	4.9	B9A	TP
	7060	841 238 751 0000	00	641 237 541		13.5	1.6	200	125	15	7	B9A	TP
	7061	704 234 178 0000	00	504 234 156		13.5	10	200	200	36	4.2	B9A	P
	7062	841 228 513 0000	00	641 227 413		6.3	0.8	100		8.5	7.8	B9A	TT
	7066	209 784 300 0000	00	208 564 300		1.4		100	100	1.1	0.4	B7G	DP
	7071	000 230 000 0000	90	*** 23* ***	D1	6.3						B9A	D
	7072	000 230 009 0000	10	*** 23* **8	C	6.3				180		B9A	R
	7073	000 230 009 0000	10	*** 23* **8	C	26				180		B9A	R
	7074	841 234 148 0000	00	641 234 146		6.3		200		12	14	B9A	T
	7075	841 234 148 0000	00	641 234 146		3.8		200		12	14	B9A	T
	7078	041 230 871 0000	00	041 230 651		6.3	2.0	250	100	9	4.4	B9A	P
	7079	041 230 871 0000	00	041 230 651		12.6		200	100	12	4.4	B9A	P

SPEC.	VALVE TYPE NUMBER	PIN CONNECTIONS				CHARACTERISTICS						BASE	VALVE CLASS
		VCM163 Tester Only		CT160, VT160, VCM Mk 1,2,3,4		Vh	Vg1	Va	Vg2	Ia	gm mA/V		
		SELECTOR SWITCH	TOP CAP	SELECTOR SWITCH	TOP CAP	V	V	V	V	mA	†Ra MΩ		
Δ	7105	501 481 230 0000	00	471 461 230		12.6	30	100				AO8	TT
Δ	7105	581 401 230 0000	00	471 461 230		12.6	30	100				AO8	TT
	7108	701 238 014 0000	00	501 236 014		6.3		250	150	3	2	B9A	P
	7110	141 230 871 0000	00	141 230 651		6.3	3.5	250	250	10	6.8	B9A	P
	7118	841 228 513 0000	00	641 227 413		6.3	1.4	100		8.5	5.6	B9A	TT
	7119	841 221 538 0000	00	641 221 437		6.3	7	200		23	6.4	B9A	TT
	7125	741 238 9X1 0000	00	541 236 891		6.3	2	250	100	9	3.8	B9A	DDP
	7137	412 344 800 0000	00	412 344 600		6.3	1.3	150		13.5	8.5	B7G	T
	7143	412 314 800 0000	00	412 314 600		3.1	1.0	200		11.5	6.7	B7G	T
	7144	841 238 510 0000	00	641 237 410		6.3	1.2	90		15	12.5	B9A	TT
	7145	701 238 014 0000	00	501 236 014		6.3	2.0	50	50	1.8		B9A	P
	7150	831 421 107 0000	00	632 421 1*5		6.3		150	125	24	34	B9A	P
	7167	412 387 100 0000	00	412 365 100		13.5	1	150	80	10	8	B7G	P
	7184	028 740 310 0000	00	026 540 310		6.3	12.5	250	250	47	4.1	AO8	P
	7189	041 230 807 0000	00	*41 23* 6*5		6.3	7.3	250	250	48	11.3	B9A	P
	7193	020 000 310 0000	84	020 000 310	A1/G1	6.3	10.5	300		11	3	AO8	T
	7199	887 231 514 0000	00	675 231 414		6.3	8	200		9	2	B9A	TP
	7199	887 231 514 0000	00	675 231 414		6.3	1.5	250	125	12.5	7	B9A	TP
	7212	127 142 380 0000	00	125 142 360		6.3	28	200	200	100	7	AO8	P
	7227	041 230 871 0000	00	*41 23* 651		27.5	2.5	40	40	8	5	B9A	P
	7233	848 238 418 0000	00	646 236 416		6.3	40	150		50	9	B9A	T
	7236	581 181 230 0000	00	471 461 230		6.3	14	150		100	12.5	AO8	TT
	7239	410 237 101 0000	80	48* 235 1*1	A1	6.3	5	300	100	10.5	4.2	B9A	P
	7244	882 345 100 0000	00	672 344 100		6.3	0.4	100		9	6	B7G	TT
	7245	412 344 800 0000	00	412 344 600		6.3	1.35	150		13.5	11	B7G	T
	7247	851 228 413 0000	00	641 227 413		6.3	2	250		1.2	1.6	B9A	TT
	7247	851 228 413 0000	00	641 227 413		6.3	8.5	250		10.5	2.2	B9A	TT
	7258	841 238 751 0000	00	641 237 541		12.5	3	150		15	4.5	B9A	TP
	7258	841 238 751 0000	00	641 237 541		12.5	9	150	125	12	7.8	B9A	TP
	7308	851 238 410 0000	00	741 236 410		6.3	1.4	90		12	11.5	B9A	TT
	7316	841 228 513 0000	00	641 227 413		6.3		100		11.8	3.1	B9A	TT
	7318	841 228 513 0000	00	641 227 413		6.3	8.5	250		11.5	2.3	B9A	TT
	7320	041 230 807 0000	00	041 230 605		6.3	7.3	250	250	48	11.3	B9A	P
	7355	028 014 370 0000	00	026 014 350		6.3	15	250	250	70	7.6	AO8	P
	7358	127 141 300 0000	00	125 141 300		6.3		200	200	100	7	AO8	P
	7370	841 221 538 0000	00	641 221 437		20	2	120		36	11.5	B9A	TT
	7382	412 300 800 0000	00	412 300 600		6.3	2	250		1.2	1.6	B7G	T
	7408	028 740 310 0000	00	026 540 310		6.3	12.5	250	250	4.7	4.6	AO8	P
	7489	841 228 513 0000	00	641 226 513		6.3	8.5	250		10.5	2.2	B9A	TT
	7489	841 228 513 0000	00	741 226 413		6.3	8.5	250		10.5	2.2	B9A	TT
	7492	851 228 413 0000	00	741 226 413		6.3		250			5.5	B9A	TT
	7498	412 381 700 0000	00	412 361 500		6.3		250	250		7.5	B7G	P
	7534	020 740 310 0000	80	*2* 54* 310	A	6.3	15.5	250	150	100	25.0	AO8	P
	7543	412 387 100 0000	00	412 365 100		6.3	1.0	250	150	10.8	5.2	B7G	P
	7551	147 238 171 0000	00	145 236 151		13	18	250	250	40	5.3	B9A	P
	7558	147 238 171 0000	00	145 236 151		6.3	18	250	250	40	5.3	B9A	P
	7561	928 740 310 0000	00	026 540 310		25		100	100	55	10.5	AO8	P
	7581	028 740 310 0000	00	026 540 310		6.3	14	250	250	72	6	B8A	P
	7586	080 400 010 2030	00	-		6.3	1.3	75		10.5	11.5	NV5	P
	7587	070 400 010 2030	80	-		6.3	0.9	125	50	10	10.6	NV5	P

SPEC.	VALVE TYPE NUMBER	PIN CONNECTIONS				CHARACTERISTICS						BASE	VALVE CLASS
		VCM163 Tester Only		CT160, VT160, VCM Mk 1,2,3,4		Vh	Vg1	Va	Vg2	Ia	gm mA/V		
		SELECTOR SWITCH	TOP CAP	SELECTOR SWITCH	TOP CAP	V	V	V	V	mA	†Ra MΩ		
	7591	028 714 370 0000	00	026 514 350		6.3	10	300	300	75	10.2	AO8	P
	7607	127 141 300 0000	80	125 141 300	A1	6.3	17	300	250	80	8	AO8	P
	7643	857 238 114 0000	00	645 237 114		6.3	2	100		14	5	B9A	TP
	7643	857 238 114 0000	00	645 237 114		6.3	2	200	175	10	6.2	B9A	TP
	7683	418 238 178 0000	00	416 236 156		6.3	0.5	300	250	12.6	5	B9A	P
	7687	857 238 114 0000	00	645 237 114		6.3	8.5	200		7.5	2.5	B9A	TP
	7687	857 238 114 0000	00	645 237 114		6.3		200	125	10	5.8	B9A	TP
	7688	141 512 386 8080	00	-		6.3	2	250		1.2	1.6	A12	TTT
	7689	141 512 386 8080	00	-		6.3	8.5	250		10.5	2.2	A12	TTT
	7690	141 512 386 8080	00	-		6.3	2	250		10	5.5	A12	TTT
	7693	412 387 100 0000	00	412 365 100		6.3	100	250	150	7.4	4.6	B7G	P
	7694	412 387 100 0000	00	412 365 100		6.3	80	250	100	9.2	3.6	B7G	P
	7695	700 234 108 0000	00	5** 234 1*6		50	11	130	130	100	11.0	B9A	P
	7699	514 228 703 0000	00	414 226 573		6.3		250		45	10	B9A	PP
	7699	514 220 783 0000	00	414 226 573		6.3		250		45	10	B9A	PP
	7700	287 113 000 0000	40	265 113 000	G1	6.3	3	250	100	2	1.2	UX6	P
	7701	141 238 717 0000	00	141 236 515		13.6	12.5	250	250	28	3.6	B9A	P
	7716	148 231 578 0000	00	146 231 457		13.6	1.0	150		1.6	3	B9A	TP
	7716	148 231 578 0000	00	146 231 457		13.6	60	200	100	24	9.5	B9A	TP
	7717	412 387 100 0000	00	412 365 100		6.3	1	125	80	10	8	B7G	P
	7719	841 228 413 0000	00	641 226 413		6.3	10.5	300		4.0	3.5	B9A	T
	7721	141 230 817 0000	00	141 230 615		6.3	10	200	150	22	35	B9A	P
	7722	141 230 817 0000	00	141 230 615		6.3	1	200	150	34	27	B9A	P
	7724	191 23X 148 0000	00	181 239 146		14	3.0	250		0.7	1.0	B9A	DDT
	7728	841 228 513 0000	00	641 227 413		6.3	2	250		10	5.5	B9A	TT
	7729	841 228 513 0000	00	641 227 413		6.3	2	250		1.2	1.6	B9A	TT
	7731	857 238 114 0000	00	641 237 114		6.3	1	150		18	8.5	B9A	TP
	7731	857 238 114 0000	00	641 237 114		6.3	0.95	250	100	10	5.2	B9A	TP
	7732	412 387 100 0000	00	412 365 100		6.3	1	200	125	13	8	B7G	P
	7733	141 223 871 0000	00	141 223 651		6.3	3	250	175	24	12	B9A	P
	7734	714 238 158 0000	00	514 236 147		6.3	21	150		35	5.4	B9A	TP
	7734	714 238 158 0000	00	514 236 147		6.3	2.0	150	150	5.5	3.2	B9A	TP
	7738	842 314 800 0000	00	642 314 600		6.3	1.2	200		12	9.5	B7G	T
	7751	028 740 310 0000	00	026 540 310		6.3	8	100	100	100	14	AO8	P
	7752	412 387 100 0000	00	412 365 100		6.3	2	150	125	5.5	3.5	B7G	P
	7754	700 234 108 0000	00	5** 234 1*6		6.3	12	150	150	100	11	B9A	P
	7755	412 387 100 0000	00	412 365 100		6.3		40	30	3	2.7	B7G	P
	7756	108 072 430 0000	00	106 052 430		6.3	36	300	300	58	4.3	AO8	P
	7757	471 034 710 0000	00	451 034 510		6.3	12.5	250	250	45	4.1	B9A	P
	7759	842 113 580 0000	00	642 113 470		26.5	1	100		6.5	5.4	AO8	TT
	7760	842 113 580 0000	00	642 113 470		26.5		26.5		3	5	AO8	TT
	7761	214 808 513 0000	00	214 607 413		12.6		150		8.2	5.5	B9A	TT
	7762	412 183 710 0000	00	412 163 510		26.5	1.2	110	100	30	4.2	AO8	P
	7763	811 234 178 0000	00	611 234 156		6.3		250	90	4.2		B9A	P
	7788	141 237 817 0000	00	141 235 615		6.3		150	150	35	50	B9A	P
	7803	841 238 510 0000	00	641 237 410		6.3	1.3	90		15	12.5	B9A	TT
	7861	214 808 413 0000	00	214 607 413		12.6	2	150		8.2	5.5	B9A	TT
	7868	741 234 708 0000	00	541 234 506		6.3	10	300	300	60	10.2	B9D	P
	7887	842 113 580 0000	00	642 113 470		26.5	1.9	100		8.5	5	AO8	TT
	7888	402 013 080 0000	00	402 031 060		26.5	2.3	150		13	6.5	AO8	T
	7889	842 113 580 0000	00	642 113 570		26.5	1.4	150		1.75	2.5	AO8	TT

SPEC.	VALVE TYPE NUMBER	PIN CONNECTIONS				CHARACTERISTICS						BASE	VALVE CLASS
		VCM163 Tester Only		CT160, VT160, VCM Mk 1,2,3,4		Vh	Vg1	Va	Vg2	la	gm mA/V		
		SELECTOR SWITCH	TOP CAP	SELECTOR SWITCH	TOP CAP	V	V	V	V	mA	†Ra MΩ		
	7895	080 400 010 2030	00	-		6.3	1	100		7	9.4	NV5	T
	7898	841 238 510 0000	00	741 236 41*		13.5	2	250		10	5.5	B9A	TT
	7905	247 008 173 0000	00	245 006 153		6.3	-6	200	185	36	6.7	B9A	P
	7984	218 881 711 4730	00	-		13.5	9	200	125	100	13.5	A12	DP
	8013A	200 300 000 0000	90	200 300 000	D1	2.5				15		B4	R
	8016	020 000 030 0000	90	020 000 030	D1	1.2						AO8	D
	8032	127 141 310 0000	80	125 141 310	A1	13.5	3.2	200	200	100	7	AO8	P
	8056	080 400 010 2030	00	-		6.3	0.8	24		8.5	7	NV5	T
	8058	010 100 010 2034	80	-		6.3	0.5	100		10	12.4	NV5	T
	8077	141 230 871 0000	00	141 23* 651		13.5	2.7	250	150	19	11.5	B9A	P
	8156	218 881 711 4730	00	-		13.5	9	200	125	75	7.6	A12	P
	8223	851 238 410 0000	00	741 236 410		6.3	1.5	100		30	20	B9A	TT
	8233	817 231 141 0000	00	615 231 141		6.3	3	150	150	50	45	B9D	P
	8255	414 234 444 0000	00	414 234 444		6.3	1.2	150		12	13	B9A	T
	8334	842 314 800 0000	00	642 314 600		6.3	1.8	200		18	10.75	B7G	T
	8348	425 238 782 0000	00	424 236 572		1.6		200	200	30	3.3	B9A	PP
	8380	070 400 010 2300	80	-	A	6.0	0	80	80	7.5	1.1	NV5	T
	8382	080 400 010 2300	00	-		6.0	55	135			1.28	NV5	T
	8417	287 431 000 0000	00	265 431 000		6.3	-12	300	300	100	23.0	AO8	P
	8441	080 400 010 2300	00	-		6.0	55	300		5.5	6.7	NV5	T
	8456	080 400 010 2300	00	-		6.0	0.7	12.0		5.5	8.0	NV5	T
	8532	412 344 800 0000	00	412 344 600		6.3	55	150		9.0	8.8		T
	8628	080 400 010 2030	00	-									-
	8808	110 101 000 0230	80	-	A	6.3	0	206		50	18.0		T
	9001	412 387 100 0000	00	412 365 100		6.3	3	250	100	2	1.4	B7G	P
	9002	812 384 100 0000	00	612 364 100		6.3	7	250		6.3	2.2	B7G	T
	9003	412 387 100 0000	00	412 365 100		6.3	3	250	100	6.7	1.8	B7G	P
	9004	203 190 000 0000	00	203 180 000		6.3				5		5AA	R
	9005	219 330 000 0000	00	218 330 000		3.6				1		5AA	D
	9006	912 390 100 0000	00	812 380 100		6.3				5		B7G	R
	9072	020 000 310 0000	84	020 000 310	A1/G1	6.3		300		15	2.5	AO8	T
	18004	423 800 000 0000	00	423 600 000		4.4	25	130		22	1	UX4	T
	18013	081 231 700 0000	40	061 231 500	G1	4		200	200	8	5	B7	P
	18014	007 231 800 0000	40	005 231 600	G1	4		200	200	35	8	B7	P
	18015	081 231 700 0000	00	061 231 500		21		150	125	8	8.3	B7	P
	18016	007 231 800 0000	00	005 231 600		21		150	125	48	9	B7	P
	18040	287 104 130 0000	00	265 104 130		18	3.4	200	200	15	10	B8B	P
	18042	741 238 001 0000	00	541 236 **1		18	1.8	200	100	8.3	8.2	B9A	P
	18043	741 238 001 0000	00	541 236 **1		6.3	1.8	200	200	8.2	8.2	B9A	P
	18045	041 230 871 0000	00	041 230 651		18	3	200	200	20	11	B9A	P
	18046	041 230 871 0000	00	041 230 651		18	3	200	100	20	11	B9A	P
	18048	281 704 130 0000	00	261 504 130		20	4.8	250	150	16	6.5	B8D	P
	95108	873 420 000 0000	00	653 320 000		1.2	1	40	40	2.2	1	B5A	P
	824476	481 581 230 0000	00	461 471 230		6.3	8	250		9	2.6	AO8	TT
	A11A	9X2 300 000 0000	00	892 300 000		4				60		B4	RR
	A11D	9X2 300 000 0000	00	892 200 000		4				60		B4	RR
	A20B	9X2 310 000 0000	00	892 310 000		4				60		B5	DD
	A23A	90X 231 800 0000	40	809 231 600	G1	4	7	250		4	2	B7	DDT
	A26	284 300 000 0000	00	264 300 000		15	1.5	90		4.5	1.1	UX4	T
	A27D	91X 238 700 0000	40	819 236 500	G1	4	6	250	250	36	9.5	B7	DDP



SPEC.	VALVE TYPE NUMBER	PIN CONNECTIONS				CHARACTERISTICS						BASE	VALVE CLASS
		VCM163 Tester Only		CT160, VT160, VCM Mk 1,2,3,4		Vh	Vg1	Va	Vg2	la	gm mA/V		
		SELECTOR SWITCH	TOP CAP	SELECTOR SWITCH	TOP CAP	V	V	V	V	mA	†Ra MΩ		
A28	284 300 000 0000	00		264 300 000		15	1.5	90		7.5	1.1	UX4	T
A30	284 300 000 0000	00		264 300 000		15	27	200		22	1.0	UX4	T
A30B	842 310 000 0000	00		642 310 000		4	2	250		10	5.5	B5	T
A30D	842 310 000 0000	00		642 310 000		4	3.5	200		6	2.4	B5	T
A32	284 300 000 0000	00		264 300 000		15	3	150		1.5	0.9	UX4	T
A36A	847 231 800 0000	50		645 231 700	G1	4	2	150		6	1.2	B7	TH
A36A	057 231 800 0000	50		645 231 700	G1	4	2	200	100	3.5		B7	TH
A36B	847 231 800 0000	50		645 231 700	G1	4		100		22	6	B7	TH
A36B	057 231 800 0000	50		645 231 700	G1	4	2	250	250	3.5	0.75	B7	TH
A36C	847 231 800 0000	50		645 231 700	G1	4	3	100		9	3.8	B7	TH
A36C	057 231 800 0000	50		645 231 700	G1	4	2.5	250	100	3.25	2.5	B7	TH
A40	284 300 000 0000	00		264 300 000		15	40.5	200		21	1.5	UX4	T
A40	284 310 000 0000	00		264 310 000		4		100			2	5AA	T
A40M	274 130 000 0000	80		254 130 000	A1	4	1.5	200	100	3	2	UX5	P
A40M	742 310 000 0000	80		542 310 000	A1	4	1.5	200	100	3	2	B5	P
A41	371 220 000 0000	84		351 220 000	A1/G1	4		250	100		2	5AA	P
A48	284 300 000 0000	00		264 300 000		15	4.5	90		4.5	1.1	UX4	T
A50A	742 310 000 0000	80		542 310 000	A1	4	2	200	100	3	2.3	B5	P
A50A	040 231 700 0000	80		040 231 500	A1	4	2	200	100	3	2.3	B7	P
A50B	081 231 700 0000	40		061 231 500	G1	4	1.5	250	250	6	3.5	B7	P
A50M	041 231 700 0000	80		041 231 500	A1	4	2	200	125	4.5	2.3	B7	P
A50M	742 310 000 0000	80		542 310 000	A1	4	2	250	125	4.5	2.3	B5	P
A50N	742 310 000 0000	80		542 310 000	A1	4	2	250	100	4.2	2.5	B5	P
A50N	041 231 700 0000	80		041 231 500	A1	4	2	250	100	4.2	2.5	B7	P
A50P	080 231 700 0000	40		060 231 500	G1	4	3	250	250	11.5	2	B7	P
A70B	842 310 000 0000	70		642 310 000	G2	4	25	250	250	36	2.6	B5	P
A70B	047 231 800 0000	00		045 231 600		4	25	250	250	36	2.6	B7	P
A70C	047 231 800 0000	00		045 231 600		4	3	250	250	36	9	B7	P
A70D	842 370 000 0000	00		642 350 000		4	5.8	250	250	36	9.5	B5	P
A70E	047 231 800 0000	00		045 231 600		4	14	250	275	72	8.5	B7	P
A70P	047 231 800 0000	00		045 231 600		4	14.5	250	250	70		B7	P
A80A	123 184 780 0000	40		123 164 560	G1	4	1.8	90		2	0.6	8SC	O
A80A	123 184 780 0000	40		123 164 560	G1	4	8.5	250	75	1.6		8SC	O
A80A	847 231 900 0000	40		645 231 700	G1	4	1.8	90	75	2	0.6	B7	O
A80A	847 231 900 0000	40		645 231 700	G1	4	8.5	250	75	1.5		B7	O
A104	842 300 000 0000	00		642 300 000		1.1	10	100		5	0.3	B4	T
A106	842 300 000 0000	00		642 300 000		1.4	9	100		2	0.4	UX4	T
A106	842 300 000 0000	40		642 300 000		1.4	9	100		2	0.4	B4	T
A109	842 300 000 0000	00		642 300 000		1.3	9	150		2	0.4	B4	T
A109	284 300 000 0000	00		264 300 000		1.4	9	150		2	0.4	UX4	T
A110	284 300 000 0000	00		264 300 000		1.4	4.5	150		4	0.4	UX4	T
A110	842 300 000 0000	00		642 300 000		1.4	4.5	150		3	0.4	B4	T
A125	842 300 000 0000	00		642 300 000		1.2	3	150		0.4	0.4	B4	T
A203	842 300 000 0000	00		642 300 000		2	30	150		12	1.5	B4	T
A205	842 300 000 0000	00		642 300 000		2	18	150		7	1.2	B4	T
A206	842 300 000 0000	00		642 300 000		2	8.5	150		3.8		B4	T
A209	842 300 000 0000	00		642 300 000		2	9	150		4	1.0	B4	T
A209	284 300 000 0000	00		264 300 000		2	9	150		4	1.0	UX4	T
A210	384 200 000 0000	00		364 200 000		2	9	150		3	1.0	UX4	T
A210	842 300 000 0000	00		642 300 000		2	9	150		3	0.9	B4	T
A211	842 300 000 0000	00		642 300 000		2	2	150		2	1.2	B4	T

SPEC.	VALVE TYPE NUMBER	PIN CONNECTIONS				CHARACTERISTICS						BASE	VALVE CLASS
		VCM163 Tester Only		CT160, VT160, VCM Mk 1,2,3,4		Vh	Vg1	Va	Vg2	la	gm mA/V		
		SELECTOR SWITCH	TOP CAP	SELECTOR SWITCH	TOP CAP	V	V	V	V	mA	†Ra MΩ		
	A214	842 300 000 0000	00	642 300 000		2	3	150		4.5	1.3	B4	T
	A225	842 300 000 0000	00	642 300 000		2	3	150		1	1	B4	T
	A225	384 200 000 0000	00	364 200 000		2	3	150		1	1	UX4	T
	A235	200 300 000 0000	90	200 300 000	D1	6.3				30		UX4	R
	A235	042 300 000 0000	80	042 300 000	A1	2		150		1.5	0.4	B4	T
	A239	230 200 000 0000	90	230 300 000	D1	2.5				60		UX4	R
	A241	842 300 000 0000	70	642 300 000	G2	2	2	20	20	1.2	1	B4	P
	A242	287 300 000 0000	40	265 300 000	G1	2	3	150	75	1.7	0.6	UX4	P
	A303	284 300 000 0000	00	264 300 000		3	27	150		3	0.6	UX4	T
	A306	284 300 000 0000	00	264 300 000		3	15	150		1.5	0.4	UX4	T
	A404	842 300 000 0000	00	642 300 000		4	10	100		4	0.4	B4	T
	A406	384 200 000 0000	00	364 200 000		4	9	100		2	0.4	UX4	T
	A406	842 300 000 0000	00	642 300 000		4	9	100		2	0.4	B4	T
	A408	842 300 000 0000	00	642 300 000		4	4	150		4	1.5	B4	T
	A409	842 300 000 0000	00	642 300 000		4	9	150		3.5	0.9	B4	T
	A409	284 300 000 0000	00	264 300 000		4	9	150		3.5	0.9	UX4	T
	A410	842 300 000 0000	00	642 300 000		4	3	150		3.5	0.5	B4	T
	A410	284 300 000 0000	00	264 300 000		4	3	150		3.5	0.5	UX4	T
	A410N	842 300 000 0000	00	642 300 000		4	3	150		3.5	0.5	B4	T
	A411	842 300 000 0000	00	642 300 000		4	3	200		6	2.5	B4	T
	A414	384 200 000 0000	00	364 200 000		4	4.5	150		3	2	UX4	T
	A414	842 300 000 0000	00	642 300 000		4	4.5	150		3	2	B4	T
	A415	842 300 000 0000	00	642 300 000		4	4	150		4	1.5	B4	T
	A416	842 300 000 0000	00	642 300 000		4	4.5	150		4	2	B4	T
	A420	842 300 000 0000	00	642 300 000		4	4	150		4	1.5	B4	T
	A425	842 300 000 0000	00	642 300 000		4	2.5	200		0.2	1.2	B4	T
	A430	842 300 000 0000	00	642 300 000		4	3	200		6	2.5	B4	T
	A430	042 300 000 0000	80	042 300 000	A1	4		150		1.5	0.5	B4	T
	A430N	842 310 000 0000	00	642 310 000		4	4.5	250		6.5	3.5	B5	T
	A435	842 300 000 0000	00	642 300 000		4	1	150		2.1	0.5	B4	T
	A440N	842 310 000 0000	00	642 310 000		4	1.6	200		0.2	2.2	B5	T
	A442	742 300 000 0000	80	542 300 000	A1	4	1	200	100	4	0.7	B4	P
	A442	274 300 000 0000	80	254 300 000	A1	4	1	200	100	1	0.4	UX4	P
	A557	802 310 000 0000	40	602 310 000	G1	4	8	150		28	2	B5	T
	A577	802 310 000 0000	40	602 310 000	G1	4	20	250		40	2	B5	T
	A600	842 300 000 0000	00	642 300 000		6.3	9	150		4	1.5	UX4	T
	A609	842 300 000 0000	00	642 300 000		6.3	9	150		4	1.5	B4	T
	A609	802 310 000 0000	40	602 310 000	G1	6.3	9	150		4	1.5	B5	T
	A615	842 300 000 0000	00	642 300 000		6.3	4.5	150		4	2.4	B4	T
	A630	842 300 000 0000	00	642 300 000		6.3	1.5	150		0.7	1.5	B4	T
	A635	842 300 000 0000	00	642 300 000		6.3		150		1.2	1.5	B4	T
	A642	742 300 000 0000	80	542 300 000	A1	6.3	1	200	100	4	0.7	B4	P
	A802	842 310 000 0000	00	642 310 000		4	3	100		2.5	2.5	B5	T
	A819	080 231 700 0000	40	060 231 500	G1	4		250	250	8	7.5	B7	P
	A863	028 700 310 0000	40	026 500 310	G1	6.3	3	250	100	2	1.2	AO8	P
	A901	047 231 800 0000	00	045 231 600		5		100	100	50	9	B7	P
	A1685	028 710 310 0000	40	026 510 310	G1	6.3	3	150	100	8	3.2	AO8	P
	A1714	412 300 800 0000	00	412 3** 600		6.3	2.2	150		10	8.5	B7G	T
	A1820	287 004 130 0000	00	265 004 130		6.3		250	250	40	10.5	B8B	P
Δ	A1834	581 481 230 0000	00	471 461 230		6.3	40	100				AO8	TT

SPEC.	VALVE TYPE NUMBER	PIN CONNECTIONS				CHARACTERISTICS						BASE	VALVE CLASS
		VCM163 Tester Only		CT160, VT160, VCM Mk 1,2,3,4		Vh	Vg1	Va	Vg2	la	gm mA/V		
		SELECTOR SWITCH	TOP CAP	SELECTOR SWITCH	TOP CAP	V	V	V	V	mA	†Ra MΩ		
	A1860	702 332 408 0000	00	502 332 406		2.5	7	200	150	35	6	B9A	T
	A2030N	842 310 000 0000	00	642 310 000		20	3	200		6	2.3	B5	T
	A2040N	842 310 000 0000	00	642 310 000		20	1.6	200		0.2	3	B5	T
	A2087	902 390 100 0000	00	8*2 380 100		4.4				5		B7G	R
	A2118	842 370 000 0000	00	642 300 000		20	3	200		6	2.3	B4	T
	A2134	412 380 700 0000	00	412 36* 500		6.3	7.8	150	150	55	9.5	B7G	P
	A2226	041 230 071 0000	80	*41 23* *51	A1	6.3	12.5	150	150	50	8.5	B9A	P
	A2272	210 010 013 0000	90	21* *1* *13	D1	6.3				10		B9G	R
Δ	A2293	010 234 008 0000	00	*1* 234 *6		6.3	23	150		100	12	B9A	T
	A2327	010 234 008 0000	00	010 234 006		6.3	3.5	250		20	6	B9A	T
	A2359	010 234 008 0000	00	010 234 006		6.5		150		100	12	B9A	T
	A2426	020 740 310 0000	80	*2* 54* 310	A1	6.3	13.5	150	150	50	8	AO8	P
	A2521	414 484 234 0000	00	414 464 234		6.3	1	150		15	15	B9A	T
	A2599	412 231 148 0000	6.3	411 231 146		6.3	1	150		16	15	B9A	T
	A2637	120 040 300 0000	80	120 040 300	A1	6.3	7.0	20		1.0	0.6	AO8	T
	A2674	211 403 708 0000	00	211 403 506		6.3	1.4	200	150	23	30	B9D	P
	A2688	412 314 800 0000	00	412 314 600		6.3	1	100		12	11.5	B7G	T
	A2738	028 741 310 0000	00	*26 541 310		6.3	19	250	200	50	10	AO8	P
	A2792	040 230 100 0000	80	*4* 23* 1**	A1	6.3	1.7	400		1	2.5	AO8	T
	A2900	851 228 413 0000	00	741 226 413		6.3	2	250		10.5	6.2	B9A	TT
	A2913	413 214 800 0000	00	413 214 600		6.3		200		15.5	14	B9A	T
	A2975	412 300 800 0000	00	412 3** 600		6.3	1.0	175		15.5	14	B7G	T
	A3042	041 230 071 0000	80	*41 23* *51	A1	6.3	12.5	150	150	50	8.5	B9A	P
	A3064	412 381 700 0000	00	412 361 500		6.3	1.6	250	250	10	7.6	B7G	P
	A4090	842 310 000 0000	00	642 310 000		4	3.5	250		6	2.4	B5	T
	A15526	110 101 000 0230	80	-		6.3	0	200		15	18	NV	T
	AA61	285 184 130 0000	00	274 164 130		6.3	5.2	250		6	2.7	B8A	TT
	AA91E	192 310 X00 0000	00	182 310 900		6.3				5		B7G	DD
	AAB1	023 1Y0 X90 0000	00	023 110 980		4						8SC	DDD
	AB1	X02 310 000 0000	90	902 310 000	D1	4				0.8		B5	DD
	ABC1	023 1X9 080 0000	40	023 198 060	G1	4	7	250		4	2	8SC	DDT
	ABC91	412 39X 800 0000	00	412 389 600		6.3	2	250		1.2	1.6	B7G	DDT
	ABL1	023 1X9 780 0000	40	023 198 560	G1	4	6	250	250	36	9	8SC	DDP
	AC/042	842 300 000 0000	00	642 300 000		2	38	300		50	5	B5	T
	AC/044	842 300 000 0000	00	642 300 000		4	38	300		50	5	B4	T
	AC/045	842 300 000 0000	00	642 300 000		4	22	250		48	3.5	B4	T
	AC/064	842 300 000 0000	00	642 300 000		4	21	200		20	3	B4	T
	AC084	842 300 000 0000	00	642 300 000		4	22	300		17	1.1	B4	T
	AC084N	842 300 000 0000	00	642 300 000		4		100		21	2.5	B4	T
	AC2	023 100 080 0000	40	023 100 060	G1	4	5.5	250		6	2.5	8SC	T
	AC2DD	98X 231 700 0000	40	869 231 500	G1	4	5	250	250	32		B7	DDP
	AC2/HL	842 310 000 0000	00	642 310 000		4	1.2	250		2.5	6.5	B5	T
	AC2/Pen	047 231 800 0000	00	045 231 600		4	5.3	250	250	32	8.5	B7	P
	AC2/PenDD	98X 231 700 0000	40	869 231 500	G1	4	5.3	250	250	32	8.5	B7	DDP
	AC3/Pen	047 231 800 0000	00	045 231 600		4	3	250	250	36	9	B7	P
	AC4/Pen	047 231 800 0000	00	045 231 600		4(5)	7	250	250	56	11	B7	P
	AC5/Pen	047 213 800 0000	00	045 213 600		4	8.5	250	250	40	9.4	B7	P
	AC5/PenDD	98X 231 700 0000	40	869 231 500	G1	4(5)	8.5	250	250	40	9.4	B7	DDP
	AC6/Pen	047 231 000 0000	80	045 231 000	A1	4(5)	6.9	300	225	63	9.5	B7	P
	AC101	802 310 000 0000	40	602 310 000	G1	4	5.5	250		7	2.7	B5	T
	AC104	842 310 000 0000	00	642 310 000		4	10	150		8.5	3.5	B5	T

SPEC.	VALVE TYPE NUMBER	PIN CONNECTIONS				CHARACTERISTICS						BASE	VALVE CLASS
		VCM163 Tester Only		CT160, VT160, VCM Mk 1,2,3,4		Vh	Vg1	Va	Vg2	la	gm mA/V		
		SELECTOR SWITCH	TOP CAP	SELECTOR SWITCH	TOP CAP	V	V	V	V	mA	†Ra MΩ		
	AC701	103 080 020 0000	40	103 060 020	G1	4	1.6	40		0.5	0.7	B8D	T
	ACD	902 310 000 0000	00	802 310 000		4						B5	D
	ACDD	9X2 310 000 0000	00	892 310 000		4						B5	DD
	AC/DDT	90X 231 800 0000	40	809 231 600	G1	4	4	200		5	2.3	B7	DDT
	AC/DX	842 310 000 0000	00	642 310 000		4	3	200		5	3.5	B5	T
	AC/G	842 310 000 0000	00	642 310 000		4	7.5	200		8	2.7	B5	T
	ACH1	847 231 800 0000	50	174 652 300	G1	4	2	150		5	2	C7	TH
	ACH1	057 231 800 0000	50	174 652 300	G1	4	2	150	75	2.5		C7	TH
	ACHL4	842 310 000 0000	00	642 310 000		4	5	250		5	3.3	B5	T
	ACHF	842 310 000 0000	00	642 310 000		4	3	200		3	2.5	B5	T
	ACHL	842 310 000 0000	00	642 310 000		4	2.5	200		7	2	B5	T
	AC/HLDD	90X 231 800 0000	40	809 231 600	G1	4	3	200		4.9	2.6	B7	DDT
	ACHLDD	XY0 231 890 0000	40	910 231 680	G1	4	3	200		4.9	2.6	B9	DDDT
	ACHL4DD	90X 231 800 0000	40	809 231 600	G1	4	3	250		7	2.5	B7	DDT
	ACHM4	742 310 000 0000	80	542 310 000	A1	4		250	100	10	2.5	B5	P
	AC/HP	041 231 700 0000	80	041 231 500	A1	4	1.5	200	100	4.2	3.2	B7	P
	AC/HP	743 210 000 0000	80	543 210 000	A1	4	1.5	200	100	4.2	3.2	B5	P
	ACHVP	742 310 000 0000	80	542 310 000	A1	4	2	200	100	3	2.3	B5	P
	ACH4	842 310 000 0000	00	642 310 000		4	4	200		3	3.3	B5	T
	AC/L	842 310 000 0000	00	642 310 000		4	13.5	200		17	4.25	B5	T
	ACL4	842 310 000 0000	00	642 310 000		4	15	250		9	4	B5	T
	AC/LP	842 310 000 0000	00	642 310 000		4	14	200	18	4.25		B5	T
	AC/ME	047 231 800 0000	00	045 231 600		4	22	250	250	0.2	†1.0	B7	TI
	ACME4	842 310 000 0000	70	642 310 000	G2	4	16	250	250	26		B5	P
	ACP	842 300 000 0000	00	642 300 000		4	21	200		19	3	B4	T
	AC/P	842 310 000 0000	00	642 310 000		4	13.5	200		17	2.7	B5	T
	ACP1	842 310 000 0000	00	642 310 000		4	28	200		24	2.3	B5	T
	ACP/4	042 310 000 0000	80	042 310 000	A1	4	1	100		20	7	B5	T
	ACP/4	842 310 000 0000	00	642 310 000		4	20	250		20	4	B5	T
	ACPN	842 370 000 0000	00	642 350 000		4	12	250	200	22		B5	P
	ACPNDH	842 370 000 0000	00	642 350 000		4	10	250	200	18		B5	P
	AC/PP	842 300 000 0000	00	642 300 000		4	25	400		50	5	B4	T
	ACPP	047 231 800 0000	00	045 231 600		4	5.5	250	250	32		B7	P
	AC/Pen	047 231 800 0000	00	045 231 600		4	15.5	250	250	32	2.7	B7	P
	AC/Pen	842 310 000 0000	70	642 310 000	G2	4	12	200	200	24	2.5	B5	P
	ACPT	842 310 000 0000	70	642 310 000	G2	4	8	250	200	31		B5	P
	ACPX4	842 310 000 0000	00	642 310 000		4	18	250		30	4	B5	T
	ACPX4A	842 300 000 0000	00	642 300 000		4	25	250		50	5	B4	T
	ACQ	047 231 800 0000	00	045 231 600		4	22	400	250	57	6	B7	P
	ACQA	-	-	045 231 600		6.3	23	400	250		6	B7	P
	AC/S1VM	742 310 000 0000	80	542 310 000	A1	6.3	1.4	200	75	5.6	1.1	B5	P
	AC/S2	742 310 000 0000	80	542 310 000	A1	4	1	200	60	6	3.4	B5	P
	AC/S2Pen	041 231 700 0000	80	041 231 500	A1	4	1.5	250	100	8	4.6	B7	P
	AC/SG	742 310 000 0000	80	542 310 000	A1	4	1.5	200	60	4.5	1.9	B5	P
	AC/SGVM	742 310 000 0000	80	542 310 000	A1	4	2	200	60	5.8	2.0	B5	P
	AC/SH	742 310 000 0000	80	542 310 000	A1	4	1.5	200	75	7.4	2.5	B5	P
	AC/SL	041 230 700 0000	80	041 230 500	A1	4	2	200	100	3.8	2	B5	P
	ACSP1	041 231 700 0000	80	041 231 500	A1	4	3	200	200	4.9	2.7	B7	P
	ACSP3	081 231 700 0000	40	061 231 500	G1	4	1.5	250	100	9	7.5	B7	P
	AC+SP3/RH	081 231 700 0000	40	061 231 500	G1	4	1.5	250	100	7	7.5	B7	P
	ACTH1	847 231 800 0000	50	654 231 700	G1	4	2.7	75		6	3	B7	TH
	ACTH1	057 231 800 0000	50	654 231 700	G1	4	3	250	100	3	3.5	B7	TH

SPEC.	VALVE TYPE NUMBER	PIN CONNECTIONS				CHARACTERISTICS						BASE	VALVE CLASS
		VCM163 Tester Only		CT160, VT160, VCM Mk 1,2,3,4		Vh	Vg1	Va	Vg2	la	gm mA/V		
		SELECTOR SWITCH	TOP CAP	SELECTOR SWITCH	TOP CAP	V	V	V	V	mA	†Ra MΩ		
	ACTH1A	218 840 730 0000	50	216 740 530	G1	4	3	75		6	3	M08	TH
	ACTH1A	218 050 730 0000	50	216 740 530	G1	4	3	250	100	3	3.5	M08	TH
	ACTP	781 231 840 0000	50	571 231 640	G1	4	3	150		1.5	1.4	B9	TP
	ACTP	781 231 840 0000	50	571 231 640	G1	4	5	250	200	5.5	1.6	B9	TP
	ACVG	742 310 000 0000	80	542 310 000	A1	4		200	75	5	3	B5	P
	ACVH	742 310 000 0000	80	542 310 000	A1	4	1.5	200	75	9.3	2.7	B5	P
	ACVP	041 231 700 0000	80	041 231 500	A1	4	1.5	200	100	5.7	2.5	B7	P
	ACVP	742 310 000 0000	80	542 310 000	A1	4	1.5	200	100	5.7	2.5	B5	P
	ACVPB	081 231 700 0000	40	061 231 500	G1	4	1.5	250	150	12	4	B7	P
	ACVP1	041 231 700 0000	80	041 231 500	A1	4	2.8	250	200	7.4	2	B7	P
	ACVP2	081 231 700 0000	40	061 231 500	G1	4	2.8	250	100	7.4	2	B7	P
	ACVP4	041 231 700 0000	80	041 231 500	A1	4		250	100	6	3	B7	P
	ACVS	742 310 000 0000	80	542 310 000	A1	4	1.5	200	75	4.4	2	B5	P
	ACVS4	742 310 000 0000	80	542 310 000	A1	4	2	250	50	6	2	B5	P
	AC/Y	047 231 800 0000	00	045 231 600		4	10	250	250	32	3.5	B7	P
	AC/Y	842 310 000 0000	70	642 310 000	G2	4	10	250	250	32	3.5	B6	P
	AC/YC	047 231 800 0000	00	045 231 600		4	10	250	250	68	7.5	B7	P
	AC/YY	047 231 800 0000	00	045 231 600		4	10	250	250	68	7.5	B7	P
	AC/Z	842 310 000 0000	70	642 310 000	G2	4	5.5	250	250	32	7.5	B5	P
	AC/Z	047 231 800 0000	00	045 231 600		4	5.5	250	250	32	7.5	B7	P
	AC/ZDD	98X 231 700 0000	40	869 231 500	G1	4	5.5	250	250	32	8	B7	DDP
	AD	291 300 000 0000	00	281 300 000		6.3				30		UX4	R
	AD1	023 004 080 0000	00	023 004 060		4	45	250		60	6	8SC	T
	AD1/350	023 004 080 0000	00	023 004 060		4	66	400		42		8SC	T
	AD1N	023 004 080 0000	00	023 004 060		4		300		60		F8	T
	AD101	842 310 000 0000	00	642 310 000		4	26.5	250		40	4.6	B5	T
	ADG	842 310 000 0000	00	642 310 000		20	10	200		10	3.5	B5	T
	ADHF	842 310 000 0000	00	642 310 000		20	3	200		5	3.5	B5	T
	ADHP	041 231 700 0000	80	041 231 500	A1	20		200	100	5	2.8	B7	P
	ADL	872 310 000 0000	00	652 310 000		20	13	200		20	3	B5	T
	ADPN	842 370 000 0000	00	642 350 000		20	15	250	200	22		B5	P
	ADVHP	041 231 700 0000	80	041 231 500	A1	20		200	100	5.5	2.5	B7	P
	AE	287 413 000 0000	00	265 413 000		13	13.5	100	100	8.5	1.6	UX6	P
	AF	291 300 000 0000	00	281 300 000		2.5				120		UX4	R
	AF2	742 310 000 0000	80	542 310 000	A1	4	2	200	100	4.2	2.5	B5	P
	AF3	023 110 780 0000	40	023 110 560	G1	4	3	250	100	8	1.8	8SC	P
	AF7	023 110 780 0000	40	023 110 560	G1	4	2	250	100	3	2.1	8SC	P
	AF8	028 748 310 0000	00	026 546 310		6.3	2	200	50	3.5		AO8	O
	AG	29X 300 000 0000	00	289 300 000		5				20		UX4	RP
	AG495	842 310 000 0000	00	642 310 000		4	4	200		4	2.5	B5	T
	AG4100	842 300 000 0000	00	642 300 000		4	3	150		5	2	B4	T
	AH1	023 147 780 0000	40	023 145 560	G1	4	2	250	75	3	1.8	8SC	P
	AH100	023 147 780 0000	40	023 145 560	G1	4	2.5	200	100	5.5	1.5	8SC	P
	AH4105	742 310 000 0000	80	542 310 000	A1	4	2	200	125	4.5	2.3	B5	P
	AK2	023 185 780 0000	40	123 164 570	G1	4	2	100	75	4.2	0.9	8SC	O
	AK2	023 185 780 0000	40	123 164 570	G1	4	2	250	75	4.5	2.2	8SC	O
	AL1	023 004 780 0000	00	023 004 560		4	15	250	250	36	2.8	8SC	P
	AL2	023 100 780 0000	40	023 100 560	G1	4	25	250	250	36	2.6	8SC	P
	AL3	247 231 800 0000	00	245 231 600		4	3	250	250	36	9	B7	P
	AL3	023 104 780 0000	00	023 104 560		4	6.5	250	250	36	9.5	8SC	P
	AL4	147 231 800 0000	00	145 231 600		4	3	250	250	36		B7	P
	AL4	023 104 780 0000	00	023 104 560		4	6.5	250	250	36	9.5	8SC	P

SPEC.	VALVE TYPE NUMBER	PIN CONNECTIONS				CHARACTERISTICS						BASE	VALVE CLASS
		VCM163 Tester Only		CT160, VT160, VCM Mk 1,2,3,4		Vh	Vg1	Va	Vg2	la	gm mA/V		
		SELECTOR SWITCH	TOP CAP	SELECTOR SWITCH	TOP CAP	V	V	V	V	mA	†Ra MΩ		
	AL4/375	147 231 800 0000	00	145 231 600		4	6	250	250	34	9.5	B7	P
	AL4/375	023 104 780 0000	00	023 104 560		4	6	250	250	34	9.5	8SC	P
	AL5	147 231 800 0000	00	145 231 600		4	14	250	250	72	8.5	B7	P
	AL5/375	023 104 780 0000	00	023 104 560		4	14	250	275	72	8.5	8SC	P
	AL60	041 231 700 0000	80	041 231 500	A1	4(5)	7	250	250	72	14.5	B7	P
	AL60	702 331 480 0000	00	502 331 460		2.4	7	200	150	35	6	B8D	P
	AL495	842 310 000 0000	00	642 310 000		4	12	250		30	4	B5	T
	AL860	702 331 408 0000	00	502 331 406		4.8	7	200	150	35	6	B9A	P
	AM1	023 104 780 0000	00	023 104 560		4	5	250	250	0.1	†2.0	8SC	TI
	AMOE	047 231 800 0000	00	045 231 600		4	14	250	250	72	9	B7	P
	AN4092	842 310 000 0000	90	642 310 000	D1	4	3.5	200		6	2	B5	DT
	APP4A	047 231 800 0000	00	045 231 600		4	16.5	250	250	36	3.5	B7	P
	APP4AS	023 100 780 0000	40	023 100 560	G1	4	16.5	250	250	36	3.5	8SC	P
	APP4B	047 231 800 0000	00	045 231 600		4	5	250	250	32	10	B7	P
	APP4BS	023 104 780 0000	00	023 104 560		4	5	250	250	32	10	8SC	P
	AP495	842 310 000 0000	00	642 310 000		4	1.5	200		2.5	5	B5	T
	APP4C	147 231 800 0000	00	145 231 600		4(5)	5	250	250	36	10	B7	P
	APP4D	147 231 800 0000	00	145 231 600		4	16	250	250	72	7	B7	P
	APP4E	147 231 800 0000	00	145 231 600		4(5)	13.5	350	275	72	8.5	B7	P
	APP4E	023 104 780 0000	00	023 104 560		4(5)	13.5	350	275	72	8.5	8SC	P
	APP4G	081 231 700 0000	40	061 231 500	G1	4(5)	6	250	250	36	10	B7	P
	APP4G	041 231 700 0000	80	005 231 600	G1	4(5)	6	250	250	36	10	B7	P
	APP4G	007 231 800 0000	40	005 231 600	G1	4	6	250	250	36	10	B7	P
	APP495	842 370 000 0000	00	642 350 000		4	23	300	200	25	2	B5	P
	APP4100	842 310 000 0000	70	642 310 000	G2	4	15	250	250	24	2.5	B5	P
	APP4120	842 310 000 0000	70	642 310 000	G2	4	15	350	200	22	3.5	B5	P
	APV4	9X2 300 000 0000	00	892 300 000		4				60		B4	RR
	APV4200	9X2 300 000 0000	00	892 300 000		4				60		B4	RR
	AR495	842 310 000 0000	00	642 310 000		4	1	100			5	B5	T
	AR4100	842 310 000 0000	00	642 310 000		4	3	200		3	2	B5	T
	AR4101	842 310 000 0000	00	642 310 000		4	1	100			3	B5	T
	AS494	742 310 000 0000	80	542 310 000	A1	4		200	100	15	1.5	B5	P
	AS495	742 310 000 0000	80	542 310 000	A1	4	2	200	100	1	3.4	B5	P
	AS4100	742 310 000 0000	80	542 310 000	A1	4	6	200	100	4	1.4	B5	P
	AS4120	742 310 000 0000	80	542 310 000	A1	4	2	200	100	3	3	B5	P
	AS4125	742 310 000 0000	80	542 310 000	A1	4	2	250	100	3	3	B4	P
	AV11	200 300 000 0000	90	200 300 000	D1	2.5						UX4	R
	AV44	120 093 000 0000	00	120 083 000		2.6				0.2			D
	AX	284 300 000 0000	00	264 300 000		5	9	150		3	0.8	UX4	T
	AX1	9X2 300 000 0000	00	892 300 000		4				60		B4	RR
	AX50	9X2 300 000 0000	00	892 300 000		4				120		B4	RR
	AZ1	023 090 0X0 0000	00	023 080 090		4				30		8SC	RR
	AZ2	023 090 0X0 0000	00	023 080 090		4				60		8SC	RR
	AZ3	023 190 0X0 0000	00	023 180 090		4				60		8SC	RR
	AZ4	023 090 0X0 0000	00	023 080 090		4(5)				60		8SC	RR
	AZ11	X02 300 090 0000	00	902 300 080		4				60		F8	RR
	AZ21	299 03X X20 0000	00	288 039 920		2				30		AO8	RR
	AZ31	020 90X 030 0000	00	020 809 030		4				30		AO8	RR
	AZ32	020 90X 030 0000	00	020 809 030		4				60		AO8	RR
	AZ33	029 0X0 300 0000	00	028 090 300		4				60		AO8	RR
	AZ41	090 00X 230 0000	00	*8* **9 230		4				30		B8A	RR

SPEC.	VALVE TYPE NUMBER	PIN CONNECTIONS				CHARACTERISTICS						BASE	VALVE CLASS
		VCM163 Tester Only		CT160, VT160, VCM Mk 1,2,3,4		Vh	Vg1	Va	Vg2	la	gm mA/V		
		SELECTOR SWITCH	TOP CAP	SELECTOR SWITCH	TOP CAP	V	V	V	V	mA	†Ra MΩ		
	AZ50	023 090 0X0 0000	00	023 080 090		4(5)				120		8SC	RR
	AZ50	9X2 300 000 0000	00	892 300 000		4(5)				120		B4	RR
	B2	842 300 000 0000	00	642 300 000		2	2	150		2	1.2	B4	T
	B7	842 300 000 0000	00	642 300 000		6.3		150		8	0.67	B4	T
	B11	842 300 000 0000	00	642 300 000		6.3		200		20	1.4	B4	T
	B21	458 230 800 0000	00	447 230 600		2	3	150		5.0	1.5	B7	TT
	B22	458 230 800 0000	00	446 230 700		2		150		5		B7	TT
	B23	842 300 000 0000	00	642 300 000		2		150		4	0.75	B4	T
	B24	458 230 800 0000	00	446 230 700		2	0	150		7		B7	TT
	B30	481 238 500 0000	00	461 237 400		1.3	0	200		30		B7	TT
	B36	581 481 230 0000	00	471 461 230		13	8	250		9	2.6	AO8	TT
	B63	284 158 300 0000	00	264 147 300		6.3	5	250		6	3.1	UX7	TT
	B65	581 481 230 0000	00	471 461 230		6.3	8	250		9	2.6	AO8	TT
	B105	284 300 000 0000	00	264 300 000		1.4	18	150		8	1.0	UX4	T
	B105	842 300 000 0000	00	642 300 000		1.4	18	150		8	1.0	B4	T
	B109	851 238 410 0000	00	741 236 410		26	1.5	200		10	6.2	B9A	TT
	B152	851 228 413 0000	00	741 226 413		6.3	2	250		10.0	5.5	B9A	TT
	B203	842 300 000 0000	00	642 300 000		2	26	150		11	1.5	B4	T
	B204	284 300 000 0000	00	264 300 000		2	22.5	125		8	0.9	UX4	T
	B205	842 300 000 0000	00	642 300 000		2	18	150		7	1.2	B4	T
	B205	284 300 000 0000	00	264 300 000		2	18	150		7	1.2	UX4	T
	B217	842 300 000 0000	00	642 300 000		4.5	4.5	150		3	1.3	B4	T
	B217	284 300 000 0000	00	264 300 000		2	4.5	150		3	1.3	UX4	T
	B228	284 300 000 0000	00	264 300 000		2	2	150		2	1.2	B4	T
	B230	548 230 800 0000	00	446 230 700		2	1	150		5.5		B7	TT
	B240	284 583 000 0000	00	264 473 000		2	0	150		15		UX6	TT
	B242	742 300 000 0000	80	542 300 000	A1	2	0	200	75	4.5	1.1	B4	P
	B242	274 300 000 0000	80	254 300 000	A1	2	0	200	75	4.5	1.1	UX4	P
	B255	742 300 000 0000	80	542 300 000	A1	2	1	150	100	1.8	1.2	B4	P
	B255	274 300 000 0000	80	254 300 000	A1	2	1	150	100	1.8	1.2	UX4	P
	B262	742 300 000 0000	80	265 300 000	G1	2	1	150	100	1.8	1.3	UX4	P
	B309	851 228 413 0000	00	741 226 413		6.3	2	250		10	5.5	B9A	TT
	B319	158 234 118 0000	00	147 234 116		7.5	1.5	90		12	6	B9A	TT
	B329	851 228 413 0000	00	741 226 413		6.3	8.5	250		10.5	2.2	B9A	TT
	B339	851 228 413 0000	00	741 226 413		6.3	2	250		1.2	1.6	B9A	T
	B342	287 300 000 0000	40	265 300 000	G1	2	2.5	150	75	4	1.3	UX4	P
	B349	158 234 118 0000	00	147 234 116		7	1.2	90		15	9	B9A	TT
	B403	842 300 000 0000	00	642 300 000		4	30	150		15	1.5	B4	T
	B403	284 300 000 0000	00	264 300 000		4	30	150		15	1.5	UX4	T
	B405	842 300 000 0000	00	642 300 000		4	18	150		11	1.6	B4	T
	B405	284 300 000 0000	00	264 300 000		4	18	150		11	1.6	UX4	T
	B406	842 300 000 0000	00	642 300 000		4	15	150		8	1.4	B4	T
	B406	284 300 000 0000	00	264 300 000		4	15	150		8	1.3	UX4	T
	B409	842 300 000 0000	00	642 300 000		4	16	250		12	2	B4	T
	B409	284 300 000 0000	00	264 300 000		4	16	250		12	2	UX4	T
	B415	284 300 000 0000	00	264 300 000		4	4.5	150		3	2	UX4	T
	B424	842 300 000 0000	00	642 300 000		4	2.3	200		6	2.5	B4	T
	B424	284 300 000 0000	00	264 300 000		4	2.3	200		6	2.5	UX4	T
	B424S	842 300 000 0000	00	642 300 000		4	3	200		3	2.5	B4	T
	B425	842 300 000 0000	00	642 300 000		4	4.5	150		3	2	B4	T

SPEC.	VALVE TYPE NUMBER	PIN CONNECTIONS				CHARACTERISTICS						BASE	VALVE CLASS
		VCM163 Tester Only		CT160, VT160, VCM Mk 1,2,3,4		Vh	Vg1	Va	Vg2	la	gm mA/V		
		SELECTOR SWITCH	TOP CAP	SELECTOR SWITCH	TOP CAP	V	V	V	V	mA	†Ra MΩ		
	B425	284 300 000 0000	00	264 300 000		4	4.5	150		3	2	UX4	T
	B435N	842 310 000 0000	90	642 310 000	D1	4	3.5	200		6	2	B5	DT
	B438	842 300 000 0000	00	642 300 000		4	2.5	200		0.2	2	B4	T
	B438	284 300 000 0000	00	264 300 000		4	2.5	200		0.2	2	UX4	T
	B438S	842 300 000 0000	00	642 300 000		4	1.5	200		2	2	B4	T
	B442	742 300 000 0000	80	542 300 000	A1	4	1	200	100	4.5	0.9	B4	P
	B442M	274 300 000 0000	80	254 300 000	A1	4	1	200	100	4.5	0.9	UX4	P
	B443	842 370 000 0000	00	642 350 000		7	17	200	150	12	1.2	B5	P
	B443	284 300 000 0000	70	264 300 000	G2	4	17	200	150	12	1.2	UX4	P
	B443S	842 300 000 0000	70	642 350 000		4	12	250	75	12	1.6	B5	P
	B443S	842 300 000 0000	70	642 300 000	G2	4	12	250	75	12	1.6	B4	P
	B443S	284 300 000 0000	70	264 300 000	G2	4	12	250	75	12	1.6	UX4	P
	B494	842 310 000 0000	00	642 310 000		4	1.5	200		4	4	B4	T
	B543	842 370 000 0000	00	642 350 000		5	15	200	150	13	1.3	B5	P
	B543	284 300 000 0000	70	264 300 000	G2	5	15	200	150	12	1.3	UX4	P
	B543	842 300 000 0000	70	642 300 000	G2	5	15	200	150	12	1.3	B4	P
	B605	842 300 000 0000	00	642 300 000		6.3	18	150		9	1.8	B4	T
	B605	284 300 000 0000	00	264 300 000		6.3	18	150		9	1.8	UX4	T
	B609	842 300 000 0000	00	642 300 000		6.3	18	250		12	1.8	B4	T
	B719	851 238 410 0000	00	741 236 410		6.3	2	250		10	6	B9A	TT
	B729	851 238 410 0000	00	741 236 410		6.3	7.7	200		10	3.4	B9A	TT
	B2006	842 310 000 0000	00	642 310 000		20	18	200		15	1.6	B5	T
	B2038	842 310 000 0000	00	642 310 000		20	3	200		6	2.3	B5	T
	B2041	802 300 000 0000	40	602 300 000	G1	20	1	100		2.5	0.1	B4	T
	B2042	742 310 000 0000	80	542 310 000	A1	20	2	200	60	4	1	B5	P
	B2043	842 310 000 0000	70	642 310 000	G2	20	18	200	200	20	1.7	B5	P
	B2044	219 004 730 0000	00	218 004 530		20	4	200	60	0.7	2.8	AO8	P
	B2044S	842 310 000 0000	90	642 310 000	D1	20	3	200		6	1.8	B5	DT
	B2045	742 310 000 0000	80	542 310 000	A1	20	2	200	60	4	1	B5	P
	B2046	742 310 000 0000	80	542 310 000	A1	20	2	200	100	3	2.2	B5	P
	B2047	742 310 000 0000	80	542 310 000	A1	20	2	200	100	4	2	B5	P
	B2055	742 310 000 0000	80	542 310 000	A1	20	1.5	200	100	3	2	B5	P
	B2099	842 310 000 0000	00	642 310 000		20	1.6	200		0.2	3	B5	T
	BA2	548 230 800 0000	00	446 230 700		2		150		1.5		B7	TT
	BB1	X02 310 000 0000	90	902 310 000	D1	16						B5	DD
	BB220A	548 230 800 0000	00	446 230 700		2	3	150		4		B7	TT
	BB240	548 230 800 0000	00	446 230 700		2	6	150		2.2		B7	TT
	BBC12	892 3X0 000 0000	40	682 390 000	G1	2	4.5	150		2.5	1.5	B5	DDI
	BCH1	487 231 800 0000	50	465 231 700	G1	24		100		5	1.2	B7	TP
	BCH1	507 231 800 0000	50	465 231 700	G1	24	2	200	50	1.3	0.7	B7	TP
	BF1	842 300 000 0000	00	642 300 000		4	15	150		8	1.3	B4	T
	BF61	281 074 130 0000	00	261 054 130		6.3	7	250	250	36	10	B8A	P
	BF62	281 074 130 0000	00	261 054 130		6.3	10	250	250	26	3.2	B8A	P
	BF451	281 074 130 0000	00	261 054 130		45	9	200	175	54.5	9.5	B8A	P
	BHP61	023 010 780 0000	40	023 010 560	G1	2	0.5	150	125	2.5	0.7	8SC	P
	BL2	872 310 000 0000	40	652 310 000	G1	30	20	200	100	40	3	B5	P
	BL63	028 148 310 0000	60	027 146 310	G1	6.3		250		14	4.2	A03	TT
	BLP61	023 004 780 0000	00	023 004 560		2		150	150	7	2.7	8SC	P
	BM968	200 300 000 0000	90	200 300 000	D1	2.5				60		UX4	R
	BPM04	412 387 400 0000	00	412 365 400		6.3	12.5	250	250	45	4.1	B7G	P
	BW3	842 370 000 0000	00	642 350 000		2	4.5	150	125	6	2.2	B5	P



SPEC.	VALVE TYPE NUMBER	PIN CONNECTIONS				CHARACTERISTICS						BASE	VALVE CLASS
		VCM163 Tester Only		CT160, VT160, VCM Mk 1,2,3,4		Vh	Vg1	Va	Vg2	la	gm mA/V		
		SELECTOR SWITCH	TOP CAP	SELECTOR SWITCH	TOP CAP	V	V	V	V	mA	†Ra MΩ		
	BW602	842 300 000 0000	00	642 300 000		2	12	150		12	3.4	B4	T
	BW1304	842 300 000 0000	00	642 300 000		2	6	150		6	3.2	B4	T
	BX2	548 230 800 0000	00	446 230 700		2		200		2.5		B7	TT
	BX604	842 300 000 0000	00	642 300 000		2	12	150		8	1.5	B4	T
	C3A	281 704 130 0000	00	261 504 130		6.3		250	150	16	6.5	B8G	P
	C3G	281 704 130 0000	00	261 504 130		6.3	1.8	200	150	13	14	AO8	P
	C3G	218 714 130 0000	00	216 514 130		6.3	1.8	250	150	13	13.5	B8B	P
	C3G	902 382 470 0000	00	802 362 450		6.3	1.8	200	150	13	14	F8	DP
	C3M	281 704 130 0000	00	261 504 130		20	4.5	250	150	15.0	6.0	B8B	P
	C9	842 300 000 0000	00	642 300 000		4	9	150		3.5	0.9	B4	T
	C10B	023 100 090 0000	00	023 100 080		20				75		8SC	R
	C10B	902 310 000 0000	00	802 310 000		20				60		B5	R
	C20C	9X2 310 000 0000	00	892 310 000		13						B5	DD
	C23B	90X 231 800 0000	40	809 231 600	G1	13	5	200		4	2	B7	DDT
	C25	842 300 000 0000	00	642 300 000		4	2.5	200		2.3	1.2	B4	T
	C30	281 704 130 0000	00	261 504 130		6.3	4.5	250	150	15	6	B8B	P
	C30B	000 231 800 0000	40	000 231 600	G1	13	4	200		4	3.2	B7	T
	C36A	847 231 800 0000	50	645 231 740		21		100		4	2	B9	TH
	C36A	057 231 800 0000	50	645 231 740		21	1.5	250	75	3		B9	TH
	C36B	847 231 800 0000	50	645 231 700	G1	29		100		4	2	B7	TH
	C36B	057 231 800 0000	50	645 231 700	G1	29		250	150	3.4		B7	TH
	C36C	847 231 800 0000	50	645 231 740		29		100		4	2	B9	TH
	C36C	057 231 800 0000	50	645 231 740		29	2.5	250	75	3	3.5	B9	TH
	C50B	081 231 700 0000	40	061 231 500	G1	12	2.2	200	200	2.5	2.8	B7	P
	C50N	081 231 700 0000	40	061 231 500	G1	13	2	200	200	9.5	2	B7	P
	C70D	023 110 780 0000	40	023 110 560	G1	33	8.5	200	200	45	8	8SC	P
	C70D	047 231 800 0000	00	045 231 600		35	8.5	200	200	45	8	B7	P
	C80B	123 174 780 0000	40	123 154 560	G1	13	1.5	200	90	1.9		8SC	O
	C109	842 300 000 0000	00	642 300 000		1	9	150		3.5	0.5	B4	T
	C125	842 300 000 0000	00	642 300 000		1	3	150		0.7	0.8	B4	T
	C135	042 300 000 0000	80	042 300 000	A1	1.4		150		1.5	1	B4	T
	C142	742 300 000 0000	80	542 300 000	A1	1	1.5	150	75	1.7	0.8	B4	P
	C144	247 135 200 0000	88	245 134 200	A1/A2	6.3	15	300	200	40	9	B7A	PP
	C180	247 135 200 0000	88	245 134 200	A1/A2	6.3	20	300	250	55	3.5	B7A	PP
	C243	842 370 000 0000	00	642 350 000		2	15	150	150	17	1.5	B5	P
	C243N	284 730 000 0000	00	642 350 000		2	4.5	150	125	6	3.2	B5	P
	C243N	284 730 000 0000	00	264 530 000		2	4.5	150	125	6	2.2	UX5	P
	C405	842 300 000 0000	00	642 300 000		4	32	250		20	1.9	B4	T
	C405	284 300 000 0000	00	264 300 000		4	32	250		20	1.9	UX4	T
	C408	842 300 000 0000	00	642 300 000		4	7	150		14	2.9	B4	T
	C443	842 370 000 0000	00	642 350 000		4	25	300	200	20	1.7	B5	P
	C443N	842 370 000 0000	00	642 350 000		4	42	300	200	20	1.5	B5	P
	C443N/S	842 370 000 0000	00	642 350 000		4	20	300	150	20	1.5	B5	P
	C453	842 370 000 0000	00	642 350 000		4	25	300	200	20	1.7	B5	P
	C508	284 300 000 0000	00	264 300 000		5	9	150		6.2	1.7	UX4	T
	C509A	842 300 000 0000	00	642 300 000		5	10	150		10	1	B4	T
	C543	843 370 000 0000	00	642 350 000		4	1	100	150		2	B5	P
	C603	842 300 000 0000	00	642 300 000		6.3	40	200		20	1.7	B4	T
	C606	842 300 000 0000	00	642 300 000		6.3	27	250		20	3.3	B4	T
	C643	842 370 000 0000	00	642 350 000		6.3	21	300	200	20	1.5	B5	P
	C1134	247 137 200 0000	88	245 135 200	A1/A2	6.3	17	400	200	20	2.5	B7A	PP

SPEC.	VALVE TYPE NUMBER	PIN CONNECTIONS				CHARACTERISTICS						BASE	VALVE CLASS
		VCM163 Tester Only		CT160, VT160, VCM Mk 1,2,3,4		Vh	Vg1	Va	Vg2	la	gm mA/V		
		SELECTOR SWITCH	TOP CAP	SELECTOR SWITCH	TOP CAP	V	V	V	V	mA	†Ra MΩ		
	CB215	548 230 800 0000	00	446 230 700		2	1	150		15	1.7	B7	TT
	CB215S	023 084 580 0000	00	023 064 470		2	1	150		12	1.7	8SC	TT
	CB220	548 230 800 0000	00	446 230 700		2	3	150		15		B7	TT
	CBC1	023 1X9 080 0000	40	023 198 060	G1	13	7	250		4	2	8SC	DDT
	CBL1	023 19X 780 0000	40	023 189 560	G1	44	8.5	200	200	45	8	8SC	DDP
	CBL6	023 1X9 780 0000	40	023 198 560	G1	44	8	100	100	45	6	8SC	DDP
	CBL31	028 X97 310 0000	40	026 985 310	G1	44	8.5	200	200	45	8	AO8	DDP
	CC1	023 100 080 0000	40	023 100 060	G1	13	3.7	200		2.6	2	8SC	T
	CC2	023 100 080 0000	40	023 100 060	G1	13	5.5	250		6	2.5	8SC	T
	CC81E	841 228 513 0000	00	641 227 413		6.3	0.6	250		10	5.5	B9A	TT
	CC82E	841 228 513 0000	00	641 227 413		6.3	8.5	250		10.5	2.2	B9A	TT
	CC86E	841 228 513 0000	00	641 227 413		6.3	9.3	250		14.5	5.2	B9A	TT
	CCa	851 228 413 0000	00	741 226 413		6.3		100		15	12	B9A	TT
	CCH1	023 178 480 0000	50	023 156 470	G1	20	10	200		2.5	2.3	8SC	TH
	CCH1	023 170 580 0000	50	023 156 470	G1	20	2	200	50	2		8SC	TH
	CCH2	023 184 780 0000	50	023 164 570	G1	29	10	200		2.5	2.3	8SC	TH
	CCH2	023 105 780 0000	50	023 164 570	G1	29	2	200	75	2		8SC	TH
	CCH35	020 048 310 0000	50	027 546 310	G1	7.5	2	100		5.4	2.2	AO8	TH
	CCH35	028 750 310 0000	50	027 546 310	G1	7.5	2	250	100	5	2.4	AO8	TH
	CF1	023 110 780 0000	40	023 110 560	G1	13	2	200	100	3	2.3	8SC	P
	CF2	023 110 780 0000	40	023 110 560	G1	13	2	200	100	4.5	2.2	8SC	P
	CF3	023 110 780 0000	40	023 110 560	G1	13	2	100	75	7.5	2.1	8SC	P
	CF7	023 110 780 0000	40	023 110 560	G1	13	2	100	100	3	2.1	8SC	P
	CF50	123 100 780 0000	40	123 100 560	G1	30	2	200	100	1.5	3.3	8SC	P
	CF51	123 100 780 0000	40	123 100 560	G1	30	2	250	100	1.7	3.3	8SC	P
	CF61	288 475 130 0000	00	276 454 130		6.3	2	100		5	2.2	B8A	TH
	CF61	280 575 130 0000	00	276 454 130		6.3	2	250	100	3	2	B8A	TH
	CF141	288 475 130 0000	00	276 454 130		14	2	100		6.4	2.2	B8A	TH
	CF141	280 575 130 0000	00	276 454 130		14	2	200	90	2.7	1.5	B8A	TH
	CH1	023 147 780 0000	40	023 145 560	G1	13	2	250	75	3	1.8	8SC	P
	CK1	023 174 780 0000	40	023 154 560	G1	13	1.5	200	90	8	3	8SC	P
	CK3	023 174 780 0000	40	023 154 560	G1	19	15	200	100	2.5		8SC	O
	CK108	287 113 000 0000	40	265 113 000	G1	6.3	3	250	100	2.3	1.2	UX6	P
	CK507AX	873 420 000 0000	00	653 420 000		1.2	2	40	40	0.9	0.6	B5A	P
	CK509AX	834 200 000 0000	00	634 200 000		0.62		40		0.1	0.1	B5A	T
	CK518AX	873 420 000 0000	00	653 420 000		1.2	2	40		0.8	0.5	B5A	T
	CK520AX	873 420 000 0000	00	653 420 000		0.62	2.5	40	40	0.2	0.1	B5A	P
	CK521AX	873 420 000 0000	00	653 420 000		1.2	3	20	20	0.6	0.4	B5A	P
	CK523AX	973 420 000 0000	00	653 420 000		1.2	1.2	20	20	0.3	0.3	B5A	P
	CK524AX	873 420 000 0000	00	653 420 000		1.2	1.2	20	20	0.4	0.3	B5A	P
	CK526AX	873 420 000 0000	00	653 420 000		1.2	1.5	20	20	0.5	0.4	B5A	P
	CK527AX	873 420 000 0000	00	653 420 000		1.2		20	20	0.1	0.2	B5A	P
	CK528AX	873 420 000 0000	00	653 420 000		1.2	1.2	40	40	0.7	0.6	B5A	P
	CK529AX	873 420 000 0000	00	653 420 000		1.2	1.2	20	20	0.3	0.3	B5A	P
	CK531DX	873 420 000 0000	00	653 420 000		1.2	1.5	20	20	0.3	0.2	B5A	P
	CK532DX	873 420 000 0000	00	653 420 000		1.2		20	20	0.4	0.4	B5A	P
	CK535AX	873 420 000 0000	00	653 420 000		1.2	1.2	20	20	0.3	0.3	B5A	P
	CK539AX	873 420 000 0000	00	653 420 000		1.2	1.4	20	20	0.2	0.3	B5A	P
	CK541DX	873 420 000 0000	00	653 420 000		1.2		30	30	0.2	0.4	B5A	P
	CK542DX	873 420 000 0000	00	653 420 000		1.2	2	20	20	0.4	0.3	B5A	P
	CK544DX	873 420 000 0000	00	653 420 000		1.2		30	30	0.1	0.3	B5A	P

SPEC.	VALVE TYPE NUMBER	PIN CONNECTIONS				CHARACTERISTICS						BASE	VALVE CLASS
		VCM163 Tester Only		CT160, VT160, VCM Mk 1,2,3,4		Vh	Vg1	Va	Vg2	la	gm mA/V		
		SELECTOR SWITCH	TOP CAP	SELECTOR SWITCH	TOP CAP	V	V	V	V	mA	†Ra MΩ		
	CK545DX	873 420 000 0000	00	653 420 000		0.6	0.6	20	20			B5A	P
	CK546	873 420 000 0000	00	653 420 000		1.2		20	20	0.4	0.4	B5A	P
	CK1002	009 0X0 010 0000	00	008 090 010		6.3				30	3k	AO8	CCR
	CK1005	009 0X2 030 0000	00	008 092 030		6.3				30		AO8	RR
	CK1006	29X 300 000 0000	00	289 300 000		2				60		UX4	RR
	CK1007	009 0X2 030 0000	00	008 092 030		1				60		AO8	RR
	CK1012	29X 300 000 0000	00	289 300 000		2				120		UX4	RR
	CK1024	009 0X0 010 0000	00	008 090 010		6.3				60	3k	AO8	CCR
	CK1028	202 322 300 0000	90	202 322 300	D1	6.3				60		B7G	R
	CK1091	200 900 300 0000	00	200 800 300		1.4						B7G	D
	CK1216	882 345 100 0000	00	672 344 100		6.3		100		5	3.4	B7G	TT
	CK5608	284 158 300 0000	00	264 147 300		2.5	6	200		6	2.4	UX7	TT
	CK5639	412 183 710 0000	00	412 163 510		6.3		150	100	21	9	B8D	P
	CK5654	412 387 100 0000	00	412 365 100		6.3	2	150	125	7.5	5	B7G	P
	CK5656	745 231 881 0000	00	544 231 671		6.3	2	150	125	15	5.8	B9A	PP
	CK5670	214 808 513 0000	00	214 607 413		6.3		150		8.5	5.5	B9A	TT
	CK5672	873 420 000 0000	00	653 420 000		1.2	6.5	60	60	3.2	0.6	B5A	P
	CK5676	824 300 000 0000	00	624 300 000		1.2	5	150		4	1.6	B5A	T
	CK5677	824 300 000 0000	00	624 300 000		1.2	5.5	150		1.9	0.8	B5A	T
	CK5678	872 430 000 0000	00	652 430 000		1.2		60	60	1.8	1.1	B5A	P
	CK5687	841 221 538 0000	00	641 221 437		6.3	2	150		36	11	B9A	TT
	CK5692	481 581 230 0000	00	461 471 230		6.3	9	250		6.5	2.2	AO8	TT
	CK5693	128 458 310 0000	00	126 447 310		6.3	6	200	7		3.2	B8B	TT
	CK5694	128 458 310 0000	00	126 447 310		6.3	6	300		7	3.2	AO8	TT
	CK5697	832 400 000 0000	00	632 400 000		0.6	3	12		0.2	0.1	B5A	T
	CK5702	873 420 000 0000	00	653 420 000		6.3		150	125	7.5	5	B7G	P
	CK5703	823 410 000 0000	00	623 410 000		6.3		150		9	5	B5A	T
	CK5704	823 100 000 0000	00	623 100 000		6.3				5		B5A	D
	CK5725	412 387 100 0000	00	412 365 100		6.3	2	150	125	5.2	3.2	B7G	P
	CK5726	192 310 X00 0000	00	182 310 900		6.3				5		B7G	DD
	CK5744	823 410 000 0000	00	623 410 000		6.3		250		4	4	B5A	T
	CK5749	412 387 100 0000	00	412 365 100		6.3		250	100	11	4.4	B7G	P
	CK5751	841 228 513 0000	00	641 227 413		6.3	3	250		1.0	1.2	B9A	TT
	CK5755	814 225 183 0000	00	614 224 173		6.3	0.9	100		0.1	0.5	B9A	TT
	CK5784	872 311 400 0000	00	652 311 400		6.3	2	150	125	5.2	3.2	B7F	P
	CK5785	923 000 000 0000	00	823 000 000		1.2							D
	CK5814	851 228 413 0000	00	741 226 413		6.3	8.5	250		10.5	2.2	B9A	TT
	CK5829	912 13X 100 0000	00	812 139 100		6.3				5		B7F	DD
	CK5851	208 037 240 0000	00	206 035 240		1.2	7.5	150	125	5.5	1.6	B8D	P
	CK5854	872 430 000 0000	00	652 430 000		1.2	2	40	40	0.8	0.5	B5A	P
	CK5873	284 115 830 0000	00	264 114 730		6.3	3	150		9	2.9	B8D	TT
	CK5875	872 430 000 0000	00	652 430 000		1.2		90	90	3.5	2.5	B5A	P
	CK5881	028 740 310 0000	00	026 540 310		6.3	14	150	250	75	6.1	AO8	P
	CK5910	287 024 300 0000	00	265 024 300		1.4		90	90	1.6	0.9	B7G	P
	CK9565	841 228 513 0000	00	641 227 413		6.3		150		8.2	6.5	B9A	TT
	CK5967	824 335 280 0000	00	624 334 270		1.2		40		3	0.1	B8D	TT
	CK5968	824 335 280 0000	00	624 334 270		1.2		40		0.7	1.3	B8D	TT
	CK5969	247 887 530 0000	00	245 675 430		1.2	3	150	40	6	1.7	B8D	PP
	CK5970	247 887 530 0000	00	245 675 430		1.2		40	40	3	1.8	B8D	PP
	CK5971	842 430 000 0000	00	642 430 000		1.2		60		3.5	2.1	B5A	T

SPEC.	VALVE TYPE NUMBER	PIN CONNECTIONS				CHARACTERISTICS						BASE	VALVE CLASS
		VCM163 Tester Only		CT160, VT160, VCM Mk 1,2,3,4		Vh	Vg1	Va	Vg2	la	gm mA/V		
		SELECTOR SWITCH	TOP CAP	SELECTOR SWITCH	TOP CAP	V	V	V	V	mA	†Ra MΩ		
	CK5972	872 430 000 0000	00	652 430 000		1.2		60	60	2.5	1.3	B5A	P
	CK5975	814 230 000 0000	00	614 230 000		6.3		100		10	5.1	B5A	T
	CK5995	902 310 000 0000	00	8*2 310 000		6.3				30		B5A	R
	CK6005	412 387 400 0000	00	412 365 400		6.3	12.5	250	250	45	4.1	B7G	P
	CK6021	842 113 580 0000	00	642 113 470		6.3		100		6.5	5.4	B8D	TT
	CK6029	824 300 000 0000	00	624 300 000		1.2	4	90		11	2	B5A	T
	CK6050	824 300 000 0000	00	624 300 000		1.2	5	150		4	1.6	B5A	T
	CK6051	872 430 000 0000	00	652 430 000		1.2	4	40	40	3	1.2	B5A	P
	CK6088	873 420 000 0000	00	653 420 000		1.2	1.2	40	40	0.7	0.6	B5A	P
	CK6092	873 420 000 0000	00	653 420 000		1.2	4.5	40	40	1.4	0.6	B5A	P
	CK6100	802 384 100 0000	00	602 364 100		6.3	8.5	250		10.5	2.2	B7G	T
	CK6101	882 345 100 0000	00	672 344 100		6.3		100		9	6	B7G	TT
	CK6110	912 0X3 100 0000	00	812 093 100		6.3						B8D	DD
	CK6111	842 113 580 0000	00	642 113 470		6.3		100		8.5	5	B8D	TT
	CK6112	842 113 580 0000	00	642 113 470		6.3		100		0.8	1.8	B8D	TT
	CK6147	208 037 240 0000	00	206 035 240		1.2	7.5	150	125	5.5	1.6	B8D	P
	CK6152	814 230 000 0000	00	614 230 000		6.3		100		10	5.1	B5A	T
	CK6186	412 387 100 0000	00	412 365 100		6.3		250	150	7	5	B7G	P
	CK6201	841 228 513 0000	00	641 227 413		6.3		250		10	5.5	B9A	TT
	CK6245	872 311 400 0000	00	652 311 400		6.3		20	30	2.5	3.3	B7G	P
	CK6247	442 813 080 0000	00	442 613 060		6.3		250			2.6	B8D	T
	CK6286	824 300 000 0000	00	624 300 000		1.2	2	60		6	2.1	B5A	T
	CK6397	208 037 240 0000	00	206 035 240		1.2	7.5	150	125	7.2	2	B8D	P
	CK6414	851 228 413 0000	00	741 226 413		6.3		200		8	5.5	B9A	TT
	CK6418	872 430 000 0000	00	652 430 000		1.2	1.2	20	20	0.2	0.3	B5A	P
	CK6419	872 430 000 0000	00	652 430 000		0.6	0.6	12	12			B5A	P
	CK6485	412 385 100 0000	00	412 365 100		6.3		300	150	10	9	B7G	P
	CK6519	873 420 000 0000	00	653 420 000		1.2		20	20	0.4	0.4	B5A	P
	CK6526	872 430 000 0000	00	652 430 000		1.2	6	100	100	6.5	1.9	B5A	P
	CK6533	844 812 380 0000	00	644 612 360		6.3		150		0.9	1.7	B8D	T
	CK6540	872 311 400 0000	00	652 311 400		6.3		150		7.5	5	B7G	P
	CK6611	842 113 580 0000	00	642 113 470		6.3		100		8.5	5	B8D	TT
	CK6612	842 113 580 0000	00	642 113 470		6.3		100		0.8	1.8	B8D	TT
	CK6872	872 311 400 0000	00	652 311 400		6.3		150	125	7.7	4.1	B7G	P
	CK6883	127 141 310 0000	80	125 141 310	A1	12.6	33	300	200	70	7	AO8	P
	CK7994	348 441 430 0000	00	346 441 430		6.3	1	100		13	18	B8D	T
	CK7995	214 311 870 0000	00	214 311 650		6.3	1.6	150	150	8	13	B8D	P
	CL1	023 100 780 0000	40	023 100 560	G1	13	14	200	200	25	2.5	8SC	P
	CL2	023 100 780 0000	40	023 100 560	G1	24	15	100	100	50	3.8	8SC	P
	CL4	023 100 780 0000	40	023 100 560	G1	33	8.5	200	200	45	8	8SC	P
	CL6	023 100 780 0000	40	023 100 560	G1	35	9.5	200	100	45	8	8SC	P
	CL33	028 740 310 0000	00	026 540 310		33	8.5	200	200	45	8	AO8	P
	C0241	028 700 300 0000	40	026 500 300	G1	2	1	150	75	3.5	1.4	AO8	P
	C0243	028 458 300 0000	00	026 447 300		2		150		4	1.8	AO8	TT
	C0244	028 740 300 0000	00	026 540 300		2	2.5	150	125	4.1	1.8	AO8	P
	C0257	021 470 300 0000	80	021 450 300	A	2	3	100	100	6	2.5	AO8	P
	C0258	028 740 300 0000	00	026 540 300		1.8	6	150	125	10	2	AO8	P
	CY1	023 100 090 0000	00	023 100 080		20				60		8SC	R
	CY1C	903 210 000 0000	00	803 210 000		20				60		B5	R
	CY2	123 1X0 090 0000	00	123 190 080		30				60		8SC	R

SPEC.	VALVE TYPE NUMBER	PIN CONNECTIONS				CHARACTERISTICS						BASE	VALVE CLASS
		VCM163 Tester Only		CT160, VT160, VCM Mk 1,2,3,4		Vh	Vg1	Va	Vg2	la	gm mA/V		
		SELECTOR SWITCH	TOP CAP	SELECTOR SWITCH	TOP CAP	V	V	V	V	mA	†Ra MΩ		
	CY21	209 001 003 0000	00	208 001 003		25				120		B9A	R
	CY31	020 090 310 0000	00	020 080 310		20				120		AO8	R
	CY32	02X 190 310 0000	00	029 180 310		30				60		AO8	RR
	CZ30	029 1X3 210 0000	00	028 193 210		80				60		AO8	RR
	CZ501D	287 113 000 0000	40	265 113 000	G1	3.5	2.5	150	125	6.5	3.5	UX6	P
	CZ504D	287 413 000 0000	00	265 413 000		5.5	13.5	250	200	40	3.5	UX6	P
	D1	123 000 000 0000	90	123 000 000	D1	4				5		B3G	R
	D1	29X 300 000 0000	00	289 300 000		5				60		UX4	RR
	D1	842 300 000 0000	00	642 300 000		4	1	40		1	0.8	B4	T
	D1C	284 230 000 0000	00	264 230 000		1.2	5	135		2	0.6	5AA	T
	D2	842 300 000 0000	00	642 300 000		4	6	100		2.2	0.2	B4	T
	D2C	284 230 000 0000	00	264 230 000		1.2	7.5	135		3	1.2	5AA	T
	D2M9	192 310 X00 0000	00	182 310 900		6.3				5		B7G	DD
	D3A	141 230 817 0000	00	141 230 615		6.3	1.2	200	150	22	36	B9A	P
	D3F	141 230 817 0000	00	141 23* 615		1.2	3	150	60	1.7	0.6	B9A	P
	D4	842 310 000 0000	00	642 310 000		4	3	200		4	3.3	B5	T
	D13U	023 100 080 0000	40	023 100 060	G1	13	5	250		6	2.5	8SC	T
	D41	9X2 310 000 0000	00	892 310 000		4						B5	DD
	D42	912 300 000 0000	00	812 300 000		4				15		B4	D
	D43	012 300 000 0000	90	012 300 000	D1	4				15		B5	D
	D61	289 174 130 0000	00	268 154 130		6.3	2	250	125	5	1.8	B8A	DP
	D63	029 1X0 310 0000	00	028 190 310		6.3				2		AO8	DD
	D77	1X2 310 900 0000	00	192 310 800		6.3				5		B7G	DD
	D105	284 300 000 0000	00	264 300 000		1	18	150		8	2	UX4	T
	D105	842 300 000 0000	00	642 300 000		1	18	150		8	2	B4	T
	D110	284 300 000 0000	00	264 300 000		4	40	250		40	2.7	UX4	T
	D110	842 300 000 0000	00	642 300 000		4	40	250		40	2.7	B4	T
	D121	289 174 130 0000	00	268 154 130		12.5	2	200	90	5	2	B8A	DP
	D143	842 370 000 0000	00	642 350 000		1	1	100	150	12	1.2	B5	P
	D152	1X2 310 900 0000	00	192 310 800		6.3						B7G	RR
	D210	842 300 000 0000	00	642 300 000		2	3	150		3.5	1.2	B4	T
	D210SW	803 200 000 0000	40	603 200 000	G1	2	4.5	150		2.4	1.3	B4	T
	D243	842 370 000 0000	00	642 350 000		2.5	27	300	200	20	2	B5	P
	D400	9X2 310 000 0000	00	892 310 000		4						B5	DD
	D401	X02 310 000 0000	90	902 310 000	D1	4				5		B4	DD
	D404	384 200 000 0000	00	364 200 000		4	40	250		40	2.7	UX4	T
	D404	842 300 000 0000	00	642 300 000		4	40	250		40	2.7	B4	T
	D410	842 300 000 0000	00	642 300 000		4	3	150		3.5	0.5	B4	T
	D418	102 300 000 0000	90	102 300 000	D1	4						B4	D
	D604	023 191 X10 0000	00	023 181 910		6.3						8SC	DD
	DA	000 231 800 0000	40	000 231 600	G1	13	2.6	200		3.7	2.2	B7	T
	DA1	842 300 000 0000	00	642 300 000		2	1	40		0.3	0.4	Sm4	T
	DA2	842 300 000 0000	00	642 300 000		2	2.1	40		1.2	0.5	Sm4	T
	DA3	842 300 000 0000	00	642 300 000		2	2.8	40		1.8	0.6	Sm4	T
	DA30	842 300 000 0000	00	642 300 000		4(5)	70	300		60	3.5	B5	T
	DA42	214 300 000 0000	80	214 300 000	A1	7.5		400			3	B4	T
	DA101	200 900 300 0000	00	200 800 300		1.2						B7G	D
	DA406	742 300 000 0000	80	542 300 000	A1	4	2.5	150	75	3	0.8	B4	P
	DAC1	023 009 080 0000	40	023 008 060	G1	1.4		90		0.1	0.3	8SC	DT

SPEC.	VALVE TYPE NUMBER	PIN CONNECTIONS				CHARACTERISTICS						BASE	VALVE CLASS
		VCM163 Tester Only		CT160, VT160, VCM Mk 1,2,3,4		Vh	Vg1	Va	Vg2	la	gm mA/V		
		SELECTOR SWITCH	TOP CAP	SELECTOR SWITCH	TOP CAP	V	V	V	V	mA	†Ra MΩ		
	DAC21	208 009 030 0000	40	206 008 030	G1	1.4		100		0.7	0.4	AO8	DT
	DAC22	284 009 030 0000	00	264 008 030		1.2		90		0.3	0.3	B8G	DT
	DAC25	284 229 230 0000	00	264 228 230		1.2		150		0.6	0.3	AO8	DT
	DAC31	038 090 200 0000	40	036 080 200	G1	1.4		90		0.4	0.3	AO8	DT
	DAC32	038 090 200 0000	40	036 080 200	G1	1.4		90		0.1	0.3	AO8	DT
	DAF1	902 382 470 0000	00	802 362 450		1.2		150	60	1.4		F8	DP
	DAF11	902 382 470 0000	00	802 362 450		1.2		90	50	0.8	0.5	F8	DP
	DAF40	289 374 230 0000	00	268 354 230		1.4		75	75	0.8	0.7	B8A	DP
	DAF70	804 239 070 0000	00	604 238 050		1.2		60	60	0.8	0.4	B8D	DP
	DAF91	209 784 300 0000	00	208 564 300		1.4	1	90	90	2	0.7	B7G	DP
	DAF92	287 904 300 0000	00	265 804 300		1.4	1	90	90	2	0.7	B7G	DP
	DAF96	209 784 300 0000	00	2*8 564 300		1.4	1.5	60	60	0.2	0.2	B7G	DP
	DAF191	209 784 300 0000	00	2*8 564 300		1.4		60	60	2.2	0.7	B7G	DP
	DAF961	209 784 300 0000	00	208 564 300		1.2	0	60	60	2.2	0.7	B7G	DP
	DAS1	742 300 000 0000	80	542 300 000	A	2	2.7	150	125	1.5	0.6	Sm4	P
	DB	548 230 800 0000	00	446 230 700		25		250		40		B7	TT
	DB3	843 200 000 0000	00	643 200 000		1.5	2.8	40		1.8	0.6	Sm4	T
	DB32	182 311 X00 0000	00	162 311 900		6.3				5		B7G	DD
	DBC21	208 0X9 030 0000	40	206 098 030	G1	1.4	1.5	150		1.6	0.9	AO8	DDT
	DBC25	209 X04 830 0000	00	208 904 630		1.2	1.5	150		1.6	0.9	B8B	DDT
	DBC31	028 X90 300 0000	40	026 980 300	G1	1.4	1.5	150		1.6	0.9	AO8	DDT
	DBS1	743 200 000 0000	80	543 200 000	A1	1.5	2.7	120	60	1.5	0.6	Sm4	P
	DC2/HLDD	90X 231 800 0000	40	809 231 600	G1	25	1	200			2	B7	DDT
	DC2P	842 310 000 0000	00	642 310 000		35	13.5	200		17	3.7	B5	T
	DC2/Pen	047 231 800 0000	00	045 231 600		35	10	250	200	30	2.5	B7	P
	DC2/Pen	842 310 000 0000	70	642 310 000	G2	35	10	250	200	30	2.5	B5	P
	DC2SG	742 310 000 0000	80	542 310 000	A	20	1	200	75	5.5	1.8	B5	P
	DC2SGVM	742 310 000 0000	80	542 310 000	A1	20	2	200	60	5.8	1.5	B5	P
	DC3HL	842 310 000 0000	00	642 310 000		25	1	90		0.3	0.4	B5	T
	DC11	802 302 400 0000	00	602 302 400		1.2	2.5	90		2	1	F8	T
	DC25	280 024 030 0000	00	260 024 030		1.2	3.5	100		1.8	0.8	B8B	T
	DC70	400 230 080 0000	00	400 230 060		1.2	4.5	150		14.5	3.7	B8D	T
	DC80	402 230 080 0000	00	402 230 060		1.2	3.5	150		20	3.5	B9A	T
	DC90	288 044 300 0000	00	266 044 300		1.4	3	90		3	1.1	B7G	T
	DC93	204 038 200 0000	00	204 036 200		1.4	5	100		10	2.4	B7G	T
	DC96	288 044 300 0000	00	266 044 300		1.4	2.5	90		2.1	1	B7G	T
	DC193	204 038 200 0000	00	2*4 *36 200		1.4	5	100		10	2.4	B7G	T
	DCC90	285 348 200 0000	00	274 346 200		1.4	2.5	90		3.7	1.8	B7G	TT
	DCH1	208 740 310 0000	50	207 540 630	G1	1.4		60		2.1	1.4	AO8	TH
	DCH1	208 750 030 0000	50	207 540 630	G1	1.4		150	125	1	1	AO8	TH
	DCH11	842 382 570 0000	00	642 273 450		1.2	4	90		0.8		F8	TH
	DCH11	052 382 570 0000	00	642 273 450		1.2		150	60	1		F8	TH
	DCH21	208 740 830 0000	50	207 540 630	G1	1.4		60		2.1	1.4	AO8	TH
	DCH21	208 750 030 0000	50	207 540 630	G1	1.4		90	60	1		AO8	TH
	DCH22	288 475 030 0000	00	276 454 030		1.2		60		1.4		AO8	TH
	DCH22	280 575 030 0000	00	276 454 030		1.2		90	50	0.7		AO8	TH
	DCH25	288 475 230 0000	00	276 454 030		1.4		60		2	1.3	AO8	TH
	DCH25	280 575 230 0000	00	276 454 030		1.4		90	60	1		AO8	TH
	DCH31	028 748 300 0000	50	027 546 300	G1	1.4		60		2.1	1.4	AO8	TH
	DCH31	028 750 300 0000	50	027 546 300	G1	1.4		90	60	1	1.4	AO8	TH
	DC/HL	842 310 000 0000	00	642 310 000		6.3	1	100			3	B5	T

SPEC.	VALVE TYPE NUMBER	PIN CONNECTIONS				CHARACTERISTICS						BASE	VALVE CLASS
		VCM163 Tester Only		CT160, VT160, VCM Mk 1,2,3,4		Vh	Vg1	Va	Vg2	la	gm mA/V		
		SELECTOR SWITCH	TOP CAP	SELECTOR SWITCH	TOP CAP	V	V	V	V	mA	†Ra MΩ		
	DC/P	842 310 000 0000	00	642 310 000		8	1	200			4.5	B5	T
	DC/SG	742 310 000 0000	80	542 310 000	A1	6.3		150	75		2.7	B5	P
	DD4	9X2 310 000 0000	00	892 310 000		4				0.8		B5	DD
	DD4D	0X1 231 900 0000	00	092 231 800		4				4		B7	DD
	DD6	9X2 310 000 0000	00	892 310 000		6.3						B5	DD
	DD6	1X2 310 900 0000	00	192 310 800		6.3				9		B7G	DD
	DD6DS	023 190 X10 0000	00	023 180 910		6.3				9		8SC	DD
	DD6G	1X2 310 900 0000	00	192 310 800		6.3						B7G	DD
	DD13	9X2 310 000 0000	00	892 310 000		13				5		B5	DD
	DD41	21X 090 130 0000	00	219 080 130		4				5		M08	RR
	DD101	21X 090 130 0000	00	219 080 130		10						M08	DD
	DD207	9X2 300 000 0000	00	892 300 000		2						B4	DD
	DD465	X02 310 000 0000	90	902 310 000	D1	4						B5	DD
	DD620	9X2 310 000 0000	00	892 310 000		6.3				1		B5	DD
	DD818	9X2 310 000 0000	00	892 310 000		8						B5	DD
	DD960	204 038 200 0000	00	204 036 200		1.4	3	60		9	2.4	B7G	T
	DDA1	9X2 310 000 0000	00	892 310 000		4						B5	DD
	DDD11	852 302 480 0000	00	742 302 460		1.2	4.5	150		1.5	1.0	F8	TT
	DDD25	208 548 030 0000	00	206 447 030		1.4	1.5	100		3.5	1.2	AO8	TT
	DDL4	9X2 310 000 0000	00	892 310 000		4				5		B5	RR
	DDP4B	X89 231 700 0000	40	968 231 500	G1	4	5	250	250	36	8	B7	DDP
	DDP4M	X19 238 700 0000	40	918 236 500	G1	4	5	250	250	36	8	B7	DDP
	DD/Pen	94X 231 700 0000	80	849 231 500	A	4	2.5	200	100	5	2.7	B7	DDP
	DDPP4B	98X 231 700 0000	40	869 231 500	G1	4	5	250	250	36	10	B7	DDP
	DDPP4BS	023 19X 780 0000	40	023 189 560	G1	4	5	250	250	36	10	8SC	DDP
	DDPP4M	98X 231 700 0000	40	869 231 500	G1	4(5)	5	250	250	36	10	B7	DDP
	DDPP6B	X89 231 700 0000	40	968 231 500	G1	6.3	6	250	250	36	9.5	B7	DDP
	DDPP6BS	023 19X 780 0000	40	023 189 560	G1	6.3	5	250	250	36	10	8SC	DDP
	DDPP39	X89 231 700 0000	40	968 231 500	G1	39	8	200	200	45	8.5	B7	DDP
	DDPP39M	X19 238 700 0000	40	918 236 500	G1	39	8	200	200	45	8.5	B7	DDP
	DDPP39S	023 1X9 780 0000	40	023 198 560	G1	44	8	200	200	45	8.5	8SC	DDP
	DDR2	278 101 403 0000	00	256 101 403		6.3	5	250	250	40	12	B9G	P
	DDR3	912 390 000 0000	00	812 380 000		6.3				60		B7G	R
	DDR7	412 380 700 0000	00	412 360 500		6.3	12.5	250	250	16	2.6	B7G	P
	DDT	X09 231 800 0000	40	908 231 600	G1	4	3	200		3.4	2.4	B7	DDT
	DDT2	892 3X0 000 0000	40	682 390 000	G1	2	3	150		1	1.4	B5	DDT
	DDT2B	892 3X0 000 0000	40	682 390 000	G1	2	4.5	150		2.5	1	B5	DDT
	DDT2BS	023 09X 080 0000	40	023 089 060	G1	2	4.5	150		2.5	1	8SC	DDT
	DDT4	90X 231 800 0000	40	809 231 600	G1	4	3	150			2.5	B7	DDT
	DDT4(S)	X09 231 800 0000	40	908 231 600	G1	4	5	200		3	3.6	B7	DDT
	DDT4(S)	023 1X9 080 0000	40	023 198 060	G1	4	5	250		4	3.6	8SC	DDT
	DDT6	90X 231 800 0000	40	809 231 600	G1	6.3	5.5	250		4	2	B7	DDT
	DDT6S	023 19X 080 0000	40	023 189 060	G1	6.3	5.5	250		5	2	8SC	DDT
	DDT13	X09 321 800 0000	40	908 321 600	G1	13	4	200		5	2	B7	DDT
	DDT13S	023 19X 080 0000	40	023 189 060	G1	13	5	200		4	3.6	8SC	DDT
	DDT16	90X 231 800 0000	40	809 231 600	G1	16	3	200		5	2.5	B7	DDT
	DDT213	90X 231 800 0000	40	809 231 600	G1	13	4	200		5	2.2	B7	DDT
	DDT215	892 3X0 000 0000	40	682 390 000	G1	2	3	150		3	1.6	B5	DDT
	DDT220	892 3X0 000 0000	40	682 390 000	G1	2.5	4.5	150		2.5	1	B5	DDT
	DE1	284 130 000 0000	00	264 130 000		2.5	21	250		5.2	1	UX5	T

SPEC.	VALVE TYPE NUMBER	PIN CONNECTIONS				CHARACTERISTICS						BASE	VALVE CLASS
		VCM163 Tester Only		CT160, VT160, VCM Mk 1,2,3,4		Vh	Vg1	Va	Vg2	la	gm mA/V		
		SELECTOR SWITCH	TOP CAP	SELECTOR SWITCH	TOP CAP	V	V	V	V	mA	†Ra MΩ		
	DE5	290 300 000 0000	00	280 300 000		2.5				120		UX4	R
	DET19	205 140 300 0000	88	204 140 300	A1/A2	6.3		300		25	2.1	UX7	TT
	DET20	020 000 310 0000	84	020 000 310	A1/G1	6.3	5.5	250		12	3	AO8	T
	DF1	032 000 780 0000	40	032 000 560	G1	1.4		90	90	1.2	0.7	8SC	P
	DF11	802 302 470 0000	00	602 302 450		1.2		90	50	0.9	0.6	F8	P
	DF16	874 230 000 0000	00	654 230 000		0.6		20	20	0.3	0.3	B5A	P
	DF22	208 701 030 0000	40	206 501 030	G1	1.4	1.5	90	90	1.4	1.1	AO8	P
	DF23	287 114 130 0000	00	265 114 130		1.2	1.5	90	60	0.6	0.6	AO8	P
	DF25	287 114 130 0000	00	265 114 130		1.2	0.5	150	60	1	0.6	AO8	P
	DF26	287 114 130 0000	00	265 114 130		1.2	1.1	150	90	1.2	0.3	AO8	P
	DF32	028 710 300 0000	40	026 510 300	G1	1.4	1.5	90	90	1.4	1.1	AO8	P
	DF33	038 700 200 0000	40	036 500 200	G1	1.4	0.5	90	90	0.8	0.7	AO8	P
	DF51	742 306 000 0000	80	542 300 000	A1	1.5		40	12	1.1	0.1	SM4	P
	DF61	872 430 000 0000	00	652 430 000		1.2	1	60	60	0.9	0.8	B5A	P
	DF62	872 430 000 0000	00	652 430 000		1.2	1	90	90	7.4	2	B5A	P
	DF63	872 430 000 0000	00	652 430 000		1.2	2.5	90	90	1.2	0.4	B5A	P
	DF70	040 230 870 0000	00	*4* 23* 650		0.6		40	40	0.4	0.2	B8D	P
	DF72	040 230 870 0000	00	*40 230 650		1.2	0	60	60	1.7	1	B8D	P
	DF73	040 230 870 0000	00	*40 230 650		1.2		90	75	1.7	0.8	B8D	P
	DF91	287 024 300 0000	00	265 024 300		1.4	0	90	75	3.5	0.9	B7G	P
	DF92	287 024 300 0000	00	265 024 300		1.4	2	90	60	1.9	0.7	B7G	P
	DF95	287 024 300 0000	00	265 024 300		1.4	1	90	75	3.7	1	B7G	P
	DF96	287 024 300 0000	00	265 *24 300		1.4	0.8	75	75	1.4	0.6	B7G	P
	DF97	287 224 300 0000	00	265 224 300		1.4		60	60	1.7	0.8	B7G	P
	DF161	028 710 300 0000	40	026 510 300	G1	0.7		20	20	0.3	0.8	AO8	P
	DF167	873 420 000 0000	00	653 420 000		0.6		20	20	0.1		B5A	P
	DF191	287 024 300 0000	00	265 *24 300		1.4		60	60	4.2	1	B7G	P
	DF668	872 430 000 0000	00	652 430 000		1.2	1.6	90	90	5.7	2.3	B5A	P
	DF669	872 430 000 0000	00	652 430 000		1.2	0	60	60	1.8	1.1	B5A	P
	DF904	287 024 300 0000	00	265 *24 300		1.4	0	90	90	1.6	0.9	B7G	P
	DF906	287 304 300 0000	00	265 3*4 300		1.4	0	40	40	3	1.7	B7G	P
	DF961	287 024 300 0000	00	265 024 300		1.2	0	60	60	3.4	0.8	B7G	P
	DFF50	248 778 530 0000	00	246 557 430		1.4	1.1	20	20	2.2	1.2	AO8	PP
	DFF51	248 778 530 0000	00	246 557 430		1.4	0	20	20	2.1	0.7	AO8	PP
	DFF101	834 782 500 0000	00	634 572 400		1.4		40	40	1	0.2	B7G	PP
	DG210	842 370 000 0000	00	642 350 000		2	1.5	100	20	1	1	B5	P
	DH	842 310 000 0000	00	642 310 000		16	3	200		6	3.7	B5	T
	DH30	X09 231 800 0000	40	908 231 600	G1	13	2	200		2.8	4.5	B7	DDT
	DH42	X09 231 800 0000	40	908 231 600	G1	4	3	250		1.1	1.2	B7	DDT
	DH63	028 9X0 310 0000	40	026 890 310	G1	6.3	3	250		1.1	1.2	AO8	DDT
	DH73	028 9X0 310 0000	40	026 890 310	G1	6.3	3	250		4.5	2	AO8	DDT
	DH74	028 9X0 310 0000	40	026 890 310	G1	13	3	250		1.1	1.2	AO8	DDT
	DH77	412 39X 800 0000	00	412 389 600		6.3	3	250		1	1.2	B7G	DDT
	DH81	284 0X9 130 0000	00	264 *98 130		6.3	3	250		1	1.2	B8B	DDT
	DH101	284 0X9 130 0000	00	264 *98 130		19	3	250		1	1.2	B8B	DDT
	DH107	412 39X 800 0000	00	412 389 600		19	3	250		1	1.2	B7G	DDT
	DH109	YX1 239 148 0000	00	†91 238 146		28	2.3	200		1	1.4	B9A	DDDT
	DH118	284 09X 130 0000	00	264 089 130		13	1	100		0.8	1.4	B8A	DDT
	DH119	841 239 0X0 0000	00	641 238 09*		13	0.7	100		0.8	1.4	B9A	DDT
	DH142	284 0X9 130 0000	00	264 098 130		14	1.6	200		1.5	1.6	B8A	DDT



SPEC.	VALVE TYPE NUMBER	PIN CONNECTIONS				CHARACTERISTICS						BASE	VALVE CLASS
		VCM163 Tester Only		CT160, VT160, VCM Mk 1,2,3,4		Vh	Vg1	Va	Vg2	Ia	gm mA/V		
		SELECTOR SWITCH	TOP CAP	SELECTOR SWITCH	TOP CAP	V	V	V	V	mA	†Ra MΩ		
	DH147	028 9X0 310 0000	40	026 890 310	G1	6.3	5.5	250		5	2	AO8	DDT
	DH149	284 1X9 130 0000	00	264 198 130		6.3	1	250		1.3	1	B8A	DDT
	DH150	284 0X9 130 0000	00	264 098 130		6.3	3	250		10	1.3	B8A	DDT
	DH718	284 09X 130 0000	00	264 089 130		6.3	3	250		1	1.3	B8A	DDT
	DH719	X91 23Y 148 0000	00	981 23† 146		6.3	3	250		1	1.3	B9A	DDDT
	DHD	X09 231 800 0000	40	908 231 600	G1	16	3.2	200		3.2	2.2	B7	DDT
	DHL	842 310 000 0000	00	642 310 000		16	1.5	150		3.8	4.5	B5	T
	DK1	023 084 780 0000	40	023 064 560	G1	1.4		90	50	1.8	0.5	8SC	H
	DK21	208 740 830 0000	40	206 540 630	G1	1.4	2	60	60	4.5	1.4	AO8	H
	DK31	02X 748 300 0000	00	027 546 300	G1	1.4	1	75	60			AO8	TH
	DK31	02X 748 300 0000	00	027 546 300	G1	1.4	1	150	90			AO8	TH
	DK32	038 748 200 0000	40	036 546 200	G1	1.4	0	90	45	0.6	0.25	AO8	H
	DK40	287 474 030 0000	00	265 454 030		1.4	2	75	75	0.9	0.7	B8A	O
	DK91	288 424 300 0000	00	266 424 300		1.4	4	75		4.5	1.2	B7G	H
	DK92	288 484 300 0000	00	266 464 300		1.4	4	60		4	1.2	B7G	H
	DK96	287 481 300 0000	00	265 401 300		1.4	1.5	75	50	1	0.4	B7G	H
	DK192	287 474 300 0000	00	265 454 300		1.4		60	60			B7G	H
	DL	842 310 000 0000	00	642 310 000		16	8	200		25	4.5	B5	T
	DL1	023 004 780 0000	00	023 004 560		1.4	3	90	90	4	1.2	8SC	P
	DL2	032 004 780 0000	00	032 004 560		1.4	7.5	90	90	7.5	1.5	8SC	P
	DL11	802 302 470 0000	00	602 302 450		1.2	4.4	90	90	3.7	1	F8	P
	DL21	208 740 030 0000	00	206 540 030		1.4	3	90	90	4	1.3	AO8	P
	DL22	287 004 330 0000	00	265 004 330		1.2	4	150	125	5	1.6	AO8	P
	DL25	287 204 330 0000	00	265 204 330		1.2	4.7	150	125	4.5	2.1	AO8	P
	DL29	287 004 320 0000	00	265 004 320		1.4	4.5	90	90	9.5	2.4	B8G	P
	DL31	038 740 200 0000	00	036 540 200		1.4	3	90	90	4	1.2	AO8	P
	DL33	038 740 320 0000	00	036 540 320		1.4	4.5	90	90	9.5	2.2	AO8	P
	DL35	038 740 200 0000	00	036 540 200		1.4	7.5	90	90	7.5	1.5	AO8	P
	DL36	038 740 200 0000	00	036 540 200		1.4	4.5	90	90	9.5	2.2	AO8	P
	DL41	380 074 220 0000	00	36* 054 220		1.4	5.8	150	125	5	1.3	B8A	P
	DL63	028 9X0 310 0000	40	026 890 310	G1	6.3	3	250		4.2	1.6	AO8	DDT
	DL64	872 430 000 0000	00	652 430 000		1.2	1.5	20	20	0.2	0.2	B5A	P
	DL65	387 420 000 0000	00	365 420 000		1.2	0.2	20	20	0.5	0.4	B5A	P
	DL66	873 420 000 0000	00	653 420 000		1.2	1.4	20	20	0.3	0.3	B5A	P
	DL67	873 420 000 0000	00	653 420 000		1.2	0.2	20	20	0.5	0.4	B5A	P
	DL68	873 420 000 0000	00	653 420 000		1.2	2.2	20	20	0.6	0.4	B5A	P
	DL69	872 430 000 0000	00	652 430 000		1.2	2.5	90	90	1.7	0.8	B5A	P
	DL70	040 230 870 0000	00	*4* 23* 650		1.2	7.5	150	90	7.5	1.9	B8D	P
	DL71	040 230 870 0000	00	*4* 23* 650		1.2	1.2	40	40	0.6	0.5	B8D	P
	DL72	040 230 870 0000	00	*4* 23* 650		1.2	4.5	40	40	1.2	0.5	B8D	P
	DL73	040 230 870 0000	00	*40 230 650		1.2	9	100	100	15	2.5	B8D	P
	DL74	028 9X0 310 0000	40	026 890 310	G1	13	3	250		5.1	1.6	AO8	DDT
	DL75	040 230 870 0000	00	*40 230 650		1.2	2.5	90	90	1.7	0.8	B8D	P
	DL82	284 0X9 130 0000	00	264 *98 130		6.3	3	250		5	1.4	B8B	DDT
	DL91	284 728 300 0000	00	264 526 300		1.4	7	90	75	7.4	1.6	B7G	P
	DL92	284 738 200 0000	00	264 536 200		1.4	7	90	75	7.4	1.6	B7G	P
	DL93	387 428 300 0000	00	365 426 300		1.4	8.4	150	90	13.3	1.9	B7G	P
	DL94	387 024 300 0000	00	365 024 300		1.4	4.5	90	90	9.5	2.1	B7G	P
	DL95	284 738 200 0000	00	264 536 200		1.4	4.5	90	90	9.5	2.1	B7G	P
	DL96	287 034 200 0000	00	265 034 200		1.4	5.2	90	90	5	1.4	B7G	P

SPEC.	VALVE TYPE NUMBER	PIN CONNECTIONS				CHARACTERISTICS						BASE	VALVE CLASS
		VCM163 Tester Only		CT160, VT160, VCM Mk 1,2,3,4		Vh	Vg1	Va	Vg2	la	gm mA/V		
		SELECTOR SWITCH	TOP CAP	SELECTOR SWITCH	TOP CAP	V	V	V	V	mA	†Ra MΩ		
	DL98	724 332 800 0000	00	524 332 600		1.25	10	150	125	30	2.2	B7G	P
	DL101	038 740 210 0000	00	036 540 210		1.4		100	100	10	2.5	B8A	P
	DL145	284 0X9 130 0000	00	264 098 130		15	5.9	250		5	2.3	B8A	DDT
	DL161	874 230 000 0000	00	654 230 000		1.4		20	20	0.5	0.5	B5A	P
	DL167	873 420 000 0000	00	653 420 000		1.2		20	20	0.5	1.5	B5A	P
	DL192	284 738 200 0000	00	264 536 200		1.4	7	60	60	7	1.5	B7G	P
	DL193	287 438 200 0000	00	265 436 200		1.4	7.5	100	60	9.5	2.9	B7G	P
	DL620	873 420 000 0000	00	653 420 000		1.2	6.5	60	60	3.1	0.6	B5A	P
	DL650	873 420 000 0000	00	653 420 000		1.2	0	20	20	0.4	0.4	B5A	P
	DL907	387 004 200 0000	00	365 004 200		1.4	5.5	150	125	15	3.1	B7G	P
	DL962	284 738 200 0000	00	264 536 200		1.4	7	60	60	7	1.5	B7G	P
	DL963	287 438 200 0000	00	265 436 200		1.2	7.5	150	60	10	2.2	B7G	P
	DLL21	248 758 330 0000	00	246 547 330		1.4	8.7	150	125	1		AO8	PP
	DLL25	048 758 230 0000	00	046 547 230		1.4	9.4	150	125	17		B8G	PP
	DLL31	328 458 270 0000	00	326 447 250		1.4	5	90	90	3		AO8	PP
	DLL101	284 785 300 0000	00	264 574 300		1.4	7	90	60	8.2	1.1	B7G	PP
	DLL102	284 785 300 0000	00	264 574 300		1.4		40	40	1.3	0.5	B7G	PP
	DLP51	023 004 780 0000	10	023 004 560	C	4	17	250	250	36	2.5	8SC	P
	DM21	028 740 030 0000	00	026 540 030		1.4		90	90	0.03	†2.0	AO8	TI
	DM70	400 230 080 0000	00	4*0 230 060		1.4	23	200	0	0.1	†1.0	B8D	TI
	DM71	400 230 080 0000	00	4*0 23* 060		1.4	23	200	0	0.1	†1.0	B8D	TI
	DN41	X89 231 700 0000	40	968 231 500	G1	4	3.3	250	200	32	10	B7	DDP
	DN143	284 7X9 130 0000	00	264 598 130		6.3	6.2	250	275	44	9.5	B8B	DDP
	D024	842 300 000 0000	00	642 300 000		4	40	400		63	7.5	B4	T
	D025	842 300 000 0000	00	642 300 000		6.3	75	300		60	3.7	B4	T
	D026	842 300 000 0000	00	642 300 000		4	92	400		63	3.8	B4	T
	D030	842 300 000 0000	00	642 300 000		4	100	400		60	6.9	B4	T
	D042	X19 238 700 0000	40	918 236 500	G1	4	6	250	250	36	9.5	B7	DDP
	DP	284 009 030 0000	00	264 008 030		16	7.5	200		25	6	AO8	DT
	DP5	842 370 000 0000	00	642 350 000		4	5	250	250	10	4	B5	P
	DP7	023 004 780 0000	00	023 004 560		4	20	250	250	20	2.5	8SC	P
	DP61	412 387 100 0000	00	412 365 100		6.3	8.5	200	125	7.7	5.1	B7G	P
	DP495/6	98X 231 700 0000	40	869 231 500	G1	4	6.5	250	250	35	9.5	B7	DDP
	DP4480	91X 238 700 0000	40	819 236 500	G1	44	8.4	200	200	46	8	B7	DDP
	DP/Pen	047 231 800 0000	00	045 231 600		16	10	200	200	31	3.5	B7	P
	DPT	047 213 800 0000	00	045 213 600		16	10	200	200	40	3.1	B7	P
	DPT	642 310 000 0000	70	642 310 000	G2	16	10	200	200	40	3	B5	P
	DS	742 310 000 0000	80	542 310 000	A1	16	1.5	200	75	2.1	1.1	B5	P
	DS	000 231 800 0000	40	000 231 600	G1	13	3	200		4	2.5	B7	T
	DSB	742 310 000 0000	80	542 310 000	A1	16	1	150	90	3.4	3.2	B5	P
	DSPen	081 231 700 0000	40	061 231 500	G1	16	1.5	200	100	4	2.3	B7	P
	DT7	842 300 000 0000	00	642 300 000		4	16	200		14	2	B4	T
	DT41	90X 321 800 0000	40	809 321 600	G1	4	1	100		3		B7	DDT
	DT215	023 09X 080 0000	40	023 089 060	G1	2	4.5	150		2.5	1	8SC	DDT
	DT215	023 089 060 0000	40	682 390 000	G1	2	4.5	150		2.5	1.5	B5	DDT
	DT436	90X 231 800 0000	40	809 231 600	G1	4	7	250		4	3.6	B7	DDT
	DT436	023 1X9 080 0000	40	023 198 060	G1	4	7	250		4	2	8SC	DDT
	DT1336	023 1X9 080 0000	40	023 198 060	G1	13	5	200		4	2	8SC	DDT
	DTV1	90X 231 800 0000	40	809 231 600	G1	13	1	100		3		B7	DDT
	DU1	902 300 000 0000	00	802 300 000		4				30		B4	R

SPEC.	VALVE TYPE NUMBER	PIN CONNECTIONS				CHARACTERISTICS						BASE	VALVE CLASS
		VCM163 Tester Only		CT160, VT160, VCM Mk 1,2,3,4		Vh	Vg1	Va	Vg2	la	gm mA/V		
		SELECTOR SWITCH	TOP CAP	SELECTOR SWITCH	TOP CAP	V	V	V	V	mA	†Ra MΩ		
	DU2	9X2 300 000 0000	00	892 300 000		4				30		B4	RR
	DU3	9X2 300 000 0000	00	892 300 000		4				15		B4	RR
	DU10	902 300 000 0000	00	802 300 000		4				60		B4	R
	DVSG	742 310 000 0000	80	542 310 000	A1	16	1	200	75	7.5	2.5	B5	P
	DVS/Pen	742 310 000 0000	80	542 310 000	A1	16	1.5	200	100	6.5	1	B5	P
	DW3	9X2 300 000 0000	00	892 300 000		4				60		B4	RR
	DW4	9X2 300 000 0000	00	892 300 000		4				60		B4	RR
	DW5	9X2 300 000 0000	00	892 300 000		4				120		B4	R
	DW8	9X2 300 000 0000	00	892 300 000		5				30		B4	RR
	DW15	9X2 300 000 0000	00	892 300 000		7.5				30		B4	RR
	DW30	9X2 300 000 0000	00	892 300 000		7.5				60		B4	RR
	DW802	842 300 000 0000	00	642 300 000		4	25	250		26	4	B5	T
	DW1508	842 310 000 0000	00	642 310 000		4	7.5	150		4	1.5	B5	T
	DW4011	842 310 000 0000	00	642 310 000		4	5	200		5	3.6	B5	T
	DW4023	842 310 000 0000	00	642 310 000		4	3	150		2.5	1.7	B5	T
	DX2	842 300 000 0000	00	642 300 000		2	3	150		3.5	1.4	B4	T
	DY30	020 000 300 0000	90	*2* 0*0 3*0	D1	1.2				2		AO8	D
	DY51	230 000 000 0000	90	230 000 000	D1	1.4				13		B3G	D
	DY70	230 000 000 0000	90	230 000 000	D1	1.2				1.8		B3G	D
	DY80	230 232 032 0000	90	23* 232 *32	D1	1.2				0.5		B9A	D
	DY86/87	230 232 032 0000	90	23* 232 *32	D1	1.4				0.5		B9A	D
	DY604	842 300 000 0000	00	642 300 000		4	15	150		8	1.3	B4	T
	DY802	230 232 032 0000	90	23* 232 *32	D1	1.4				0.5		B9A	R
	DZ2	742 300 000 0000	80	542 300 000	A1	4	1	200	100	4	0.7	B4	P
	E	842 300 000 0000	00	642 300 000		4	9	200		1.7	0.4	B4	T
	E	284 300 000 0000	00	264 300 000		3	22.5	125		6.5		UX4	T
	E1C	218 49X 130 0000	00	216 489 130		6.3	5	200		4.5	2	AO8	DDT
	E1F	218 074 300 0000	00	216 054 300		6.3	3	250	100	2	1.4	B7	P
	E2e	087 014 023 0000	00	065 014 023		18	3.5	220	220	42	10.5	B9	P
	E4	842 300 000 0000	00	642 300 000		4	16	200		12	1.8	B4	T
	E4D	9X2 300 000 0000	00	892 300 000		4				30		B4	RR
	E4F	9X2 300 000 0000	00	892 300 000		4				60		B4	RR
	E4H	902 300 000 0000	00	802 300 000		4				125		B4	R
	E4K	003 200 000 0000	90	003 200 000	D1	4				60		B5	R
	E4L	003 200 000 0000	90	003 200 000	D1	4				120		B5	R
	E20V	023 100 090 0000	00	023 100 080		20				60		8SC	R
	E55L	817 231 141 0000	00	615 231 141		6.3		150	150	50	45	B9D	P
	E80CC	841 338 512 0000	00	641 337 412		6.3	5.5	250		6	2.8	B9A	TT
	E80CF	857 238 114 0000	00	645 237 114		6.3	2	100		14	5	B9A	TP
	E80CF	857 238 114 0000	00	645 237 114		6.3	2	200	175	10	6.2	B9A	TP
	E80F	701 238 014 0000	00	501 236 014		6.3	1.6	250	100	3	1.8	B9A	P
	E80L	041 230 871 0000	00	041 230 651		6.3	4.5	200	200	30	9	B9A	P
	E81CC	841 228 513 0000	00	641 227 413		6.3	2	250		10	5.5	B9A	TT
	E81L	041 230 871 0000	00	041 230 651		6.3	3	200	200	20	11	B9A	P
	E82CC	841 228 513 0000	00	641 227 413		6.3	8.5	250		10.5	2.2	B9A	TT
	E83CC	841 228 513 0000	00	641 227 413		6.3	2	250		1.2	1.6	B9A	TT
	E83F	742 238 001 0000	00	541 236 **1		6.3	2	200	125	10	9	B9A	P
	E84L	041 230 807 0000	00	*41 23* 6*5		6.3	7.3	250	250	48	11	B9A	P
	E86C	841 234 148 0000	00	641 234 146		6.3	2	200		12	14	B9A	T
	E87L	041 230 871 0000	00	041 230 651		6.3	6	250	150	36	10	B9A	P
	E88C	414 234 484 0000	00	414 234 464		6.3	1.2	150		12.5	13.5	B9A	T

SPEC.	VALVE TYPE NUMBER	PIN CONNECTIONS				CHARACTERISTICS						BASE	VALVE CLASS
		VCM163 Tester Only		CT160, VT160, VCM Mk 1,2,3,4		Vh	Vg1	Va	Vg2	la	gm mA/V		
		SELECTOR SWITCH	TOP CAP	SELECTOR SWITCH	TOP CAP	V	V	V	V	mA	†Ra MΩ		
□	E88CC	841 238 510 0000	00	641 237 510		6.3	1.2	90		15	12.5	B9A	TT
	E88CC/01	841 238 510 0000	00	641 237 510		6.3	1.2	90		15	12.5	B9A	TT
	E90CC	882 345 100 0000	00	672 344 100		6.3	2.1	100		8.5	6	B7G	TT
	E90F	412 387 100 0000	00	412 365 100		6.3	1.2	250	150	7.4	4.6	B7G	P
	E91AA	192 310 X00 0000	00	182 310 900		6.3				9		B7G	D
	E91H	412 387 100 0000	00	412 365 100		6.3	5	150	75	0.5	0.6	B7G	H
	E92CC	882 345 100 0000	00	672 344 100		6.3	1.7	150		8.5	6	B7G	TT
	E95F	412 387 100 0000	00	412 365 100		6.3	2	150	125	7.5	5.5	B7G	P
	E99F	412 387 100 0000	00	412 365 100		6.3	20	250	100	9.2	3.8	B9A	P
	E130	028 740 310 0000	00	026 540 310		6.3	15	250	250		†1.0	AO8	TI
	E130L	020 740 310 0000	80	*2* 54* 310	A1	6.3	15.5	250	150	100	27	AO8	P
	E135	387 304 220 0000	00	365 304 220		12.6	25	400		80		AO8	P
	E180CC	841 228 513 0000	00	641 227 413		6.3	1.9	150		8.5	6.3	B9A	TT
	E180F	141 230 817 0000	00	141 23* 615		6.3	1.25	180	150	13	16.5	B9A	P
	E181CC	841 228 513 0000	00	641 227 413		6.3	3	150		8.5	4.7	B9A	TT
	E182CC	841 221 538 0000	00	741 221 436		6.3	2	150		36	15	B9A	TT
	E184	141 230 871 0000	00	141 230 651		6.3	2.5	200	200	10	15	B9A	P
	E186F	141 230 817 0000	00	141 23* 615		6.3	1.4	200	150	11.5	16	B9A	P
	E188CC	841 328 510 0000	00	641 327 410		6.3	1.4	90		12	11.5	B9A	TT
	E220B	548 230 800 0000	00	446 230 700		2	1	150		3	2.5	B7	TT
	E235	842 300 000 0000	00	642 300 000		2	7.5	150		13	3	B4	T
	E235L	028 740 310 0000	00	*26 54* 310		6.3	8.2	100	100	100	14	AO8	P
	E236L	020 740 310 0000	80	*2* 54* 310	A1	6.3	8.2	100	100	100	14	AO8	P
	E280F	141 230 817 0000	00	141 23* 615		6.3	1.8	200	150	20	26	B9A	P
	E282F	141 230 817 0000	00	141 23* 615		6.3		150	150	35	26	B9A	P
	E283CC	148 231 085 0000	00	146 231 074		6.3	2	250		1.2	1.6	B9A	TT
	E288CC	851 238 410 0000	00	741 236 410		6.3	1.5	100		30	18	B9A	TT
	E405	842 300 000 0000	00	642 300 000		4	32	250		20	2	B4	T
	E406	842 300 000 0000	00	642 300 000		4	34	250		8	2.3	B4	T
	E408	842 300 000 0000	00	642 300 000		4	30	400		26	2	B4	T
	E408N	842 300 000 0000	00	642 300 000		4	36	400		30	2.7	B4	T
	E409	842 310 000 0000	00	642 310 000		4	16	200		12	1.3	B5	T
	E410	842 300 000 0000	00	642 300 000		4	28	400		30	6	B4	T
	E414	842 310 000 0000	00	642 310 000		4	6	150		6.5	2	B5	T
	E414	842 300 000 0000	00	642 300 000		4	15	150		8	1.3	B4	T
	E415	842 310 000 0000	00	642 310 000		4	8	200		6	1.4	B5	T
	E415	284 130 000 0000	00	264 130 000		4	8	200		6	1.4	UX5	T
	E420	842 300 000 0000	00	642 300 000		4	18	150		11	1.6	B4	T
	E422	842 300 000 0000	00	642 300 000		4	16	250		12	5	B4	T
	E424	842 310 000 0000	00	642 310 000		4	2.5	200		6	2.4	B5	T
	E424N	842 310 000 0000	00	642 310 000		4	3.5	200		6	2.4	B5	T
	E424R	812 300 000 0000	40	612 300 000	G1	4	5	200		6	1.6	B4	T
	E425	842 310 000 0000	00	642 310 000		4	4.5	150		3	3	B5	T
	E428	842 310 000 0000	00	642 310 000		4	3	200		6	2.4	B5	T
	E430	842 310 000 0000	00	642 310 000		4	3	150		4	2	B5	T
	E430N	842 310 000 0000	00	642 310 000		4	15	200		15	3	B5	T
	E435	842 310 000 0000	00	642 310 000		4	1.5	200		3	1	B5	T
	E438	842 310 000 0000	00	642 310 000		4	3	200		2.5	1.5	B5	T
	E441	842 310 000 0000	70	642 310 000	G2	4		100	100	1.7	1.0	B5	P
	E442	742 310 000 0000	80	542 310 000	A1	4	1.3	200	60	1.5	0.9	B5	P

SPEC.	VALVE TYPE NUMBER	PIN CONNECTIONS				CHARACTERISTICS						BASE	VALVE CLASS
		VCM163 Tester Only		CT160, VT160, VCM Mk 1,2,3,4		Vh	Vg1	Va	Vg2	la	gm mA/V		
		SELECTOR SWITCH	TOP CAP	SELECTOR SWITCH	TOP CAP	V	V	V	V	mA	†Ra MΩ		
E442S	742 310 000 0000	80		542 310 000	A1	4	2	200	60	4	1	B5	P
E443H	842 370 000 0000	00		642 350 000		4	40	400	200	30	1.9	B5	P
E444	279 413 000 0000	80		258 413 000	A1	4	3	200	90	4	3	UX6	DP
E444N	279 413 000 0000	80		258 413 000	A1	4	3	100	90	4	3	UX6	DP
E444S	842 310 000 0000	90		642 310 000	D1	4	3.5	200		6	2	B5	DT
E445	742 310 000 0000	80		542 310 000	A1	4	2	200	100	6	1	B5	P
E446	742 310 000 0000	80		542 310 000	A1	4	2	200	100	3	2.3	B5	P
E447	742 310 000 0000	80		542 310 000	A1	4	2	200	125	4.5	2.3	B5	P
E448	184 772 300 0000	40		164 552 300	G1	4	1.5	200	125	3	0.6	C7	P
E449	187 472 300 0000	40		165 452 300	G1	4	2	200	75	3	1.8	C7	P
E451	842 370 000 0000	00		642 350 000		4		400	250	17		B4	P
E452T	742 310 000 0000	80		542 310 000	A1	4	2	200	100	3	2	B5	P
E452T	274 130 000 0000	80		254 130 000	A1	4	2	200	100	3	2	UX5	P
E453	047 231 800 0000	00		045 231 600		4	15	250	250	24	2.5	B7	P
E454	218 90X 300 0000	40		216 809 300	G1	4	3.5	200		3.5	1.6	UX7	DDT
E455	742 310 000 0000	80		542 310 000	A1	4	1.5	200	100	3	2	B5	P
E455	274 130 000 0000	80		254 130 000	A1	4	1.5	200	100	3	2	UX5	P
E463	047 231 800 0000	00		045 231 600		4	22	250	250	36	2.7	B7	P
E499	842 310 000 0000	00		642 310 000		4	1.6	200		0.2	4	D5	T
E501D	287 113 000 0000	40		265 113 000	G1	3.5	2.5	250	125	6.5	3.5	UX6	P
E501R	287 113 000 0000	40		265 113 000	G1	6.3	2.5	250	125	6.5	3.5	UX6	P
E504D	287 413 000 0000	00		265 413 000		5	13.5	250	200	40	3.5	UX6	P
E504P	287 423 000 0000	00		265 423 000		6.3	13.3	250	200	40	3.5	UX6	P
E646	020 090 310 0000	00		020 080 310		26				120		AO8	R
E703	842 300 000 0000	00		642 300 000		7.5	100	400		30	1	B5	T
E810F	141 237 817 0000	00		141 235 615		6.3	1.9	150	150	35	50	B9A	P
E851	030 X09 020 0000	00		030 908 020		5				120		AO8	RR
E1137	388 448 822 0000	00		366 446 622		6.3	2.3	250		32	16	B9G	T
E1148	020 000 310 0000	84		020 000 310	A1/G1	6.3	5.5	250		14	3	AO8	T
E1192	021 470 310 0000	80		021 450 310	A1	6.3	11	250	150	30	3.5	AO8	P
E1242	287 711 403 0000	00		265 511 403		6.3	30	300	250	25	1.9	B9G	P
E1320	028 740 310 0000	00		026 540 310		6.3	11	250	250	1		AO8	TI
E1323	020 000 310 0000	84		020 000 310	A1/G1	6.3	3	100		25	6.7	AO8	T
E1413	287 024 300 0000	00		265 024 300		1.4	1	90	75	3.5	0.9	B7G	P
E1478	842 300 000 0000	00		642 300 000		4	1	100			6.9	B5	T
E1484	209 784 300 0000	00		208 564 300		1.4	1	90	90	2.7	0.6	B7G	DP
E1489	241 878 153 0000	00		241 657 143		6.3		350	250	21	3.9	B9G	PP
E1517	412 381 700 0000	00		412 361 500		6.3	2.5	200	200	8	2.5	B7G	P
E1518	412 381 700 0000	00		412 361 500		6.3	2	250	250	10	7.5	B7G	P
E1606	481 581 230 0000	00		461 471 230		6.3	8	250		9	2.6	AO8	TT
E1624	802 384 100 0000	00		6*2 364 100		6.3	8.5	250		10.5	2.2	B7G	T
E1654	028 710 310 0000	40		026 510 310	G1	6.3	1.5	200	200	10.9	8.5	AO8	P
E1662	412 380 700 0000	00		412 360 500		6.3	12	250	250	20	2.6	B7G	P
E1677	002 300 000 0000	90		002 300 000	D1	2				15		B4	R
E1678	028 710 310 0000	40		026 510 310	G1	13	3	250	100	7.6	1.5	B7G	P
E1681	028 740 310 0000	00		026 540 310		15	13	200	175	35	2.5	AO8	P
E1682	020 900 310 0000	00		020 800 310		30				120		AO8	R
E1706	278 071 483 0000	00		256 051 463		6.3	8	250	175	80	13	B9G	P
E1709	084 581 230 0000	00		064 471 230		6.3	2	250		2	1.3	AO8	TT

SPEC.	VALVE TYPE NUMBER	PIN CONNECTIONS				CHARACTERISTICS						BASE	VALVE CLASS
		VCM163 Tester Only		CT160, VT160, VCM Mk 1,2,3,4		Vh	Vg1	Va	Vg2	la	gm mA/V		
		SELECTOR SWITCH	TOP CAP	SELECTOR SWITCH	TOP CAP	V	V	V	V	mA	†Ra MΩ		
E1733	00X 009 230 0000	00	009 **8 230		6.3				60		B8B	RR	
E1736	287 004 130 0000	00	265 004 130		6.3	4.4	250	250	40	10.5	B8B	P	
E1740	20X 009 130 0000	00	209 008 130		6.3				30		B8B	RR	
E1751	1X2 310 900 0000	00	192 310 800		6.3				5		B7G	RR	
E1780	00X 009 230 0000	00	009 **8 230		4				30		B8B	RR	
E1787C	318 741 120 0000	00	316 541 120		6.3	9	250	175	50	8	B9G	P	
E1794	287 104 130 0000	00	265 104 130		19	3	250	75	2.5	2.8	B8B	P	
E1795	290 009 130 0000	00	280 008 130		50				120		B8B	R	
E1796	287 004 130 0000	00	265 004 130		80	9.5	200	175	70	10	B8B	P	
E1809	287 104 130 0000	00	265 104 130		6.3	2	250	100	8	2.8	B8B	P	
E1813	284 1X9 130 0000	00	264 198 130		19	3	250		1	1.2	B8B	DDT	
E1816	384 728 300 0000	00	364 526 300		1.4	7	90	75	7.4	1.5	B7G	P	
E1835	007 231 800 0000	40	005 231 600	G1	13	4.4	250	250	40	10.5	B7	P	
E1838	284 1X9 130 0000	00	264 198 130		6.3	3	250		1	1.2	B8B	DDT	
E1848	284 0X9 130 0000	00	264 *98 130		6.3	2	200		10	1.4	B8B	DDT	
E1861	041 230 871 0000	00	041 230 651		6.3		200	200	19	10	B9A	P	
E1884	002 300 000 0000	90	002 300 000	D1	2				5		B4	R	
E1912	412 39X 800 0000	00	412 389 600		6.3	3	250		1	1.2	B7G	DDT	
E1935	241 878 153 0000	00	241 657 143		6.3	26	250	200	30	3.9	B9G	PP	
E1938	902 30X 100 0000	00	802 309 100		6.3				30		B7G	RR	
E1969	742 378 400 0000	00	542 376 400			2	100		5	2.2	B7G	TH	
E1969	742 378 400 0000	00	542 376 400			1	250	75	5.3	2.2	B7G	TH	
E1976	412 381 700 0000	00	412 361 500		19	2.5	200	200	8	2.5	B7G	P	
E1984	412 380 700 0000	00	412 36* 500		6.3	5.5	250	250	30	10	B7G	P	
E1985	291 009 300 0000	00	281 008 300		40				60		B7G	R	
E1987	412 380 700 0000	00	412 36* 500		40	8	200	150	50	10	B7G	P	
E1994	581 481 230 0000	00	471 461 230		13	8	250			2.6	AO8	TT	
E2004	020 000 300 0000	90	*2* 0*0 3*0	D1	1.2				5		AO8	R	
E2020N	842 310 000 0000	00	642 310 000		20	18	200		15	1.5	B5	T	
E2047	412 381 700 0000	00	412 361 500		12.5	2.5	200	200	8	2.5	B7G	P	
E2122	X02 309 100 0000	00	902 308 100		6.3				30		B7G	RR	
E2128	241 878 153 0000	00	241 657 143		19	16.5	250	150	30	3.9	B9G	PP	
E2134	412 380 700 0000	00	412 36* 500		6.3		200	200	55	9.5	B7G	P	
E2153	412 380 700 0000	00	412 36* 500		13	8	200	150	50	10	B7G	P	
E2178	001 230 009 0000	00	**1 23* 88*		20				120		B9A	R	
E2179	041 230 071 0000	80	*41 23* *51	A1	20	12	150	150	50	8.5	B9A	P	
E2185	028 040 310 0000	00	026 040 310		6.3	8	250		9	2.6	AO8	T	
E2223	000 230 009 0000	00	*** 23* **8		25				120		B9A	R	
E2256	001 230 009 0000	00	**1 23* **8		20				120		B9A	R	
E2382	021 040 370 0000	80	021 *4* 350	A1	52		150	150	100	16	AO8	P	
E2754	802 441 443 0000	00	602 441 443		6.3	1.5	150		25	25	B9A	T	
E2965	241 878 153 0000	00	142 756 143		6.3	18	300	200	40	3.7	B9G	PP	
E7002	000 230 000 0000	90	*** 23* ***	D	1.4				60		B9A	R	
E7003	000 230 000 0000	90	*** 23* ***	D1	6.3						B9A	D	
E7004	192 310 X00 0000	00	182 310 900		6.3				5		B7G	DD	
E7005	901 230 X00 0000	00	801 23* 9**		6.3						B9A	DD	
E7006	901 230 X00 0000	00	801 23* 9**		6.3				30		B9A	RR	
E7007	000 230 009 0000	10	*** 23* **8	C	17				120		B9A	R	
E7010	001 230 009 0000	00	**1 23* **8		55				120		B9A	R	
E7011	001 230 009 0000	00	**1 23* **8		38				180		B9A	R	
E7013	802 304 100 0000	00	602 304 100		6.3	2	250		20	5.5	B7G	T	

SPEC.	VALVE TYPE NUMBER	PIN CONNECTIONS				CHARACTERISTICS						BASE	VALVE CLASS
		VCM163 Tester Only		CT160, VT160, VCM Mk 1,2,3,4		Vh	Vg1	Va	Vg2	la	gm mA/V		
		SELECTOR SWITCH	TOP CAP	SELECTOR SWITCH	TOP CAP	V	V	V	V	mA	†Ra MΩ		
E7014	802 304 100 0000	00		602 304 100		9.4	2	250		10	5.5	B7G	T
E7015	841 228 513 0000	00		641 227 413		6.3		100		11	3	B9A	TT
E7017	841 228 513 0000	00		641 227 413		6.3	1	100		0.5	1.2	B9A	TT
E7019	148 235 118 0000	00		146 234 117		6.3	1.5	90		12	6	B9A	TT
E7020	841 238 510 0000	00		641 237 410		6.3	2.3	250		10	5.9	B9A	TT
E7022	841 238 510 0000	00		641 237 410		7	1.2	90		15	12.5	B9A	TT
E7023	148 235 118 0000	00		146 234 117		7	1.5	100		12	6	B9A	TT
E7024	841 238 510 0000	00		641 237 410		9	2.1	200		10	5.8	B9A	TT
E7025	841 238 510 0000	00		641 237 410		26	2.1	200		10	5.8	B9A	TT
E7026	141 230 871 0000	00		141 230 651		6.3	2	150	150	10	7.4	B9A	P
E7027	701 238 014 0000	00		501 236 014		6.3	2	250	150	3	2.5	B9A	P
E7032	128 740 310 0000	00		126 540 310		6.3	100	250	250	100	11	AO8	P
E7033	041 230 071 0000	80		*41 23* *51	A1	6.3	38.5	250	250	32	4.6	AO8	P
E7034	741 231 800 0000	00		541 231 600		6.3		200	200	36	10	B9A	P
E7040	020 740 310 0000	80		020 540 310	A1	25	21	150	150	100	11	AO8	P
E7041	041 230 071 0000	80		*41 23* *51	A1	21.5	24	150	150	45	6.5	B9A	P
E7043	741 231 800 0000	00		541 231 600		15	2.3	150	150	36	10	B9A	P
E7044	041 230 807 0000	00		*41 23* 6*5		16	6	200	200	34	10	B9A	P
E7050	741 238 9X1 0000	00		541 236 891		6.3	2	250	100	9	3.8	B9A	DDP
E7051	857 238 114 0000	00		645 237 114		6.3	1	150		18	8.5	B9A	TP
E7051	857 238 114 0000	00		645 237 114		6.3	1	150	100	10	5.2	B9A	TP
E7053	415 238 718 0000	00		414 237 516		6.3		100		3.5	2.2	B9A	TP
E7053	415 238 718 0000	00		414 237 516		6.3	22.5	250	250	28	5	B9A	TP
E7054	9X1 23Y 148 0000	00		891 238 146		28	1.8	175		1	1.4	B9A	DDDT
E7055	415 238 718 0000	00		414 237 516		16		100		3.5	2.2	B9A	TP
E7055	415 238 718 0000	00		414 237 516		16	11.5	150	150	41	7.5	B9A	TP
E7056	857 238 114 0000	00		645 237 114		9.5	1	150		18	8.5	B9A	TP
E7056	857 238 114 0000	00		645 237 114		9.5	1	150	100	10	5.2	B9A	TP
E7057	742 238 9X1 0000	00		542 236 891		19	2	250	100	9	3.8	B9A	DDP
E7059	415 238 718 0000	00		414 237 516		50		100		3.5	2.2	B9A	TP
E7059	415 238 718 0000	00		414 237 516		50	16	200	200	35	6.8	B9A	TP
E7060	288 044 300 0000	00		266 044 300		1.4	2.5	90		2.1	1	B7G	T
E7062	287 024 300 0000	00		265 024 300		1.4		90	90	1.6	0.8	B7G	P
E7066	200 784 300 0000	00		200 564 300		1.4		90	90	1.1	0.4	B7G	P
E7071	000 230 000 0000	90		000 230 000	D1	6.3						B9A	D
E7072	000 230 009 0000	10		000 230 008	C	6.3				180		B9A	R
E7073	000 230 009 0000	10		000 230 008	C	26				180		B9A	R
E7074	841 234 148 0000	00		641 234 146		6.3	1.5	150		12	14	B9A	T
E7075	841 234 148 0000	00		641 234 146		3.8	1.5	150		12	14	B9A	T
E7076	841 238 510 0000	00		641 236 410		6.3	0.4	12.6		1	2.6	B9A	TT
E7078	041 230 871 0000	00		041 230 651		6.3	2	250	100	9	4.4	B9A	P
E7079	041 230 871 0000	00		041 230 651		12.6	1	150	100	12	4.4	B9A	P
E7081	020 740 310 0000	80		020 540 310	A1	6.3	21	150	150	100	11	AO8	P
E7087	481 238 157 0000	00		461 237 145		15	1.7	200		3	4	B9A	TP
E7087	481 238 157 0000	00		461 237 145		15	2.1	150	150	18	11	B9A	TP
E7088	481 238 157 0000	00		461 237 145		6.3	1.7	200		3	4	B9A	TP
E7088	481 238 157 0000	00		461 237 145		6.3	2.1	150	150	18	11	B9A	TP
E7108	701 238 014 0000	00		501 236 014		6.3	2	250	150	3	2	B9A	P
E7109	141 230 817 0000	00		141 230 615		6.3	1.1	200	150	13	16.5	B9A	P
E7110	141 230 871 0000	00		141 230 651		6.3	3.5	250	250	10	6.8	B9A	P
E7143	412 314 800 0000	00		412 314 600		3.1	1	200.		11.5	6.7	B7G	T

SPEC.	VALVE TYPE NUMBER	PIN CONNECTIONS				CHARACTERISTICS						BASE	VALVE CLASS
		VCM163 Tester Only		CT160, VT160, VCM Mk 1,2,3,4		Vh	Vg1	Va	Vg2	Ia	gm mA/V		
		SELECTOR SWITCH	TOP CAP	SELECTOR SWITCH	TOP CAP	V	V	V	V	mA	†Ra MΩ		
	E7144	814 238 510 0000	00	614 237 410		6.3	1.2	90		15	12.5	B9A	TT
	E7145	701 238 014 0000	00	501 236 014		6.3	2	50	50	1.8		B9A	P
	EA40	200 900 130 0000	00	200 800 130		6.3				5		B8A	R
	EA50	123 000 000 0000	90	123 000 000	D1	6.3						B3G	D
	EA63	741 231 800 0000	00	541 231 600		6.3	5.5	250	250	36	10.5	B9A	P
	EA76	291 390 000 0000	00	281 380 000		6.3				5		B5B	R
	EA111	023 010 000 0000	90	023 010 000	D1	6.3				60		F8	R
	EA962	200 100 300 0000	90	200 100 300	D1	6.3						B7G	D
	EAA11	912 300 1X0 0000	00	812 300 190		6.3				5		F8	RR
	EAA91	192 311 X00 0000	00	182 311 900		6.3				5		B7G	DD
	EAA171	122 913 3X0 0000	00	122 813 390		6.3		200		10		B8B	DD
	EAA901	192 310 X00 0000	00	182 310 900		6.3				10		B7G	DD
	EAB1	023 1Y0 9X0 0000	00	023 1†0 890		6.3				0.8		8SC	DDD
	EABC80	YX1 239 148 0000	00	†91 238 146		6.3	3	250		1	1.2	B9A	DDDT
	EAC91	912 314 800 0000	00	812 314 600		6.3	3.2	200		7.4	2.8	B7G	DT
	EAF21	287 914 130 0000	00	265 814 130		6.3	2	250	100	6	2.8	B8G	DP
	EAF41	289 174 130 0000	00	268 154 130		6.3	4	250	100	5	1.8	B8A	DP
	EAF42	289 174 130 0000	00	268 154 130		6.3	2	250	100	5	1.8	B8A	DP
	EAF81	041 238 907 0000	00	041 236 805		6.3	2	250	100	9	3.6	B9A	DP
	EAF801	741 238 091 0000	00	541 236 081		6.3	2	250	200	9	3.8	B9A	DP
	EB4	023 190 X10 0000	00	023 180 910		6.3				0.8		8SC	DD
	EB11	902 301 1X0 0000	00	802 301 190		6.3				9		F8	DD
	EB34	02X 190 310 0000	00	029 180 310		6.3				5		AO8	DD
	EB40	209 0X0 130 0000	00	208 090 130		6.3				40		B8A	DD
	EB41	201 X09 130 0000	00	201 908 130		6.3				5		B8A	RR
	EB91	1X2 310 900 0000	00	192 310 800		6.3				9		B7G	DD
	EB111	023 004 080 0000	00	023 004 060		4	50	250		60	5.2	F8	T
	EBC1	023 1X9 080 0000	40	023 198 060	G1	6.3	7	250		4	2	8SC	DDT
	EBC3	023 19X 080 0000	40	023 189 060	G1	6.3	5.5	250		5	2	8SC	DDT
	EBC11	9X2 310 480 0000	00	892 301 460		6.3	8	250		5	2.2	F8	DDT
	EBC21	284 09X 130 0000	00	264 *89 130		6.3	5.5	250		5	2	B8B	DDT
	EBC30	023 19X 080 0000	40	023 189 060	G1	6.3	4.3	200		4	2	8SC	DDT
	EBC33	028 9X0 310 0000	40	026 890 310	G1	6.3	5.5	250		5	2	AO8	DDT
	EBC41	284 09X 130 0000	00	264 089 130		6.3	3	250		1	1.3	B8A	DDT
	EBC51	39X 080 420 0000	00	389 060 420		6.3	7.3	250		70	4	B9G	DDT
	EBC80	841 239 0X0 0000	00	641 238 090		6.3	3	250		1	1.2	B9A	DDT
	EBC90	412 39X 800 0000	00	412 389 600		6.3	3	250		1	1.2	B7G	DDT
	EBC91	412 39X 800 0000	00	412 389 600		6.3	2	250		1.2	1.6	B7G	DDT
	EBF1	023 19X 780 0000	40	023 189 560	G1	6.3	3	250	125	9	1.1	8SC	DDP
	EBF2	023 19X 780 0000	40	023 189 560	G1	6.3	2	250	100	5	1.8	8SC	DDP
	EBF2G	208 79X 130 0000	40	206 589 130	G1	6.3	2	250	100	5	1.8	AO8	DDP
	EBF11	9X2 381 470 0000	00	892 361 450		6.3	2	250	100	5	1.8	F8	DDP
	EBF15	X92 381 470 0000	00	982 361 450		6.3	2	260	100	12	5	F8	DDP
	EBF21	289 X74 130 0000	00	268 954 130		6.3	3.2	250	100	7.5	2.2	B8G	DDP
	EBF32	028 9X7 310 0000	40	026 895 310	G1	6.3	2	250	100	5	1.8	AO8	DDP
	EBF35	218 79X 130 0000	40	216 589 130	G1	6.3	2	250	100	5	1.8	AO8	DDP
	EBF80	741 238 9X1 0000	00	541 236 891		6.3	2	250	90	5	2.2	B9A	DDP
	EBF81	741 238 9X1 0000	00	541 236 891		6.3	2	250	75	6.7	1.1	B9A	DDP
	EBF83	741 238 9X1 0000	00	541 236 891		6.3		12	12	0.4	1	B9A	DDP
	EBF89	741 238 9X1 0000	00	541 236 891		6.3	2	250	100	9	3.8	B9A	DDP



SPEC.	VALVE TYPE NUMBER	PIN CONNECTIONS				CHARACTERISTICS						BASE	VALVE CLASS
		VCM163 Tester Only		CT160, VT160, VCM Mk 1,2,3,4		Vh	Vg1	Va	Vg2	la	gm mA/V		
		SELECTOR SWITCH	TOP CAP	SELECTOR SWITCH	TOP CAP	V	V	V	V	mA	†Ra MΩ		
	EBF171	9X2 741 380 0000	00	892 541 360		6.3	3.2	250	80	6	1.8	B8B	DDP
	EBF175	231 9X1 817 4000	00	-		6.3	2	250	80	6	5	B10B	DDP
	EBL1	023 19X 780 0000	40	023 189 560	G1	6.3	6	250	250	36	9.5	8SC	DDP
	EBL21	284 7X9 130 0000	00	264 598 130		6.3	6	250	250	36	9	B8B	DDP
	EBL31	028 9X7 310 0000	40	026 895 310	G1	6.3	6	250	250	36	9.5	AO8	DDP
	EBL71	284 79X 130 0000	00	264 589 130		6.3	5	250	250	44	9.5	AO8	DDP
	EC2	023 100 080 0000	40	023 100 060	G1	6.3	5.5	250		6	2.5	8SC	T
	EC21	208 401 003 0000	00	206 401 003		6.3	4	250		5	2.7	B9G	T
	EC31	028 040 310 0000	00	026 040 310		6.3	16	250		20	3.2	AO8	T
	EC40	244 844 130 0000	00	244 644 130		6.3	1.5	300		15	12	B8A	T
	EC41	208 040 130 0000	00	206 040 130		6.3	5.5	300		20	4.5	B8A	T
	EC52	241 800 003 0000	00	241 600 003		6.3	2.6	250		10	6.5	B9G	T
	EC53	123 000 000 0000	84	123 000 000	A1/G1	6.3	3.3	200		7.5	2.9	B3G	T
	EC54	244 844 413 0000	00	244 644 413		6.3	1.5	250		10	9	B9G	T
	EC56	021 000 310 0000	84	*21 0*0 310	A1/G1	6.3	1.8	200		30	15	AO8	T
	EC70	482 803 180 0000	00	462 603 160		6.3	2	100		13	5.5	B8D	T
	EC71	402 013 080 0000	00	402 013 060		6.3	1.25	100		8.5	5.8	B8D	T
	EC80	441 230 448 0000	00	441 230 446		6.3	1.5	250		15	12	B9A	T
	EC81	401 230 080 0000	00	401 230 060		6.3	2	150		30	5.5	B9A	T
	EC84	414 484 234 0000	00	414 464 234		6.3	1.1	150		16	10	B9A	T
	EC86	841 234 148 0000	00	641 234 146		6.3	1.5	75		12	14	B9A	T
	EC86C	841 234 148 0000	00	641 234 146		6.3	1.5	200		12	14	B9A	T
	EC88	414 234 484 0000	00	414 234 464		6.3	1.2	150		12.5	14	B9A	T
	EC90	802 384 100 0000	00	6*2 364 100		6.3	8.5	250		10.5	2.2	B7G	T
	EC91	412 314 800 0000	00	412 314 600		6.3	2	250		6	8.5	B7G	T
	EC92	802 304 100 0000	00	602 304 100		6.3	2	250		10	5	B7G	T
	EC93	842 314 800 0000	00	642 314 600		6.3	4	100		16	8	B7G	T
	EC94	842 314 800 0000	00	642 314 600		6.3	2.5	100		16	6.6	B7G	T
	EC95	142 381 100 0000	00	142 361 100		6.3	1.2	200		10	10.5	B7G	T
	EC96	412 314 800 0000	00	412 314 600		6.3	1	200		11.5	6.7	B7G	T
	EC97	142 238 100 0000	00	142 356 100		6.3	1	150		11	13	B7G	T
	EC98	412 344 800 0000	00	412 344 600		6.3	1.3	150		13.5	13.5	B7G	T
	EC157	021 000 310 0000	84	*21 0*0 310	A1/G1	6.3	2	200		44	22	AO8	T
	EC158	021 000 310 0000	84	*21 0*0 310	A1/G1	6.3	4	200		68	15	AO8	T
	EC760	482 803 180 0000	00	462 603 160		6.3	2.4	150		13	6.5	B8D	T
	EC806S	841 234 148 0000	00	641 234 146		6.3		200		12	14	B9A	T
	EC900	412 380 100 0000	00	412 360 100		6.3	1	150		11.5	14.5	B7G	T
	EC903	842 314 800 0000	00	642 314 600		6.3	4	100		16	8	B7G	T
	EC1000	102 013 080 0000	40	102 *13 060	G1	6.3	2	80		14	14.5	B8D	T
	EC1030	444 123 480 0000	00	444 123 460		6.3		100		7	16	B8D	T
	EC8010	414 234 484 0000	00	414 234 464		6.3		200		25	28	B9A	T
	EC8020	414 234 484 0000	00	414 234 464		6.3	2.4	200		40	60	B9A	T
	ECC31	028 548 310 0000	00	027 446 310		6.3	4.5	250		6	2.3	AO8	TT
	ECC32	481 581 230 0000	00	461 471 230		6.3	4.6	250		6	2.3	AO8	TT
	ECC33	481 581 230 0000	00	461 471 230		6.3	4	250		9	3.8	AO8	TT
	ECC34	481 581 230 0000	00	461 471 230		6.3	16	250		10	2.2	AO8	TT
	ECC35	481 581 230 0000	00	461 471 230		6.3	2.5	250		2.3	2	AO8	TT
	ECC40	285 184 130 0000	00	274 164 130		6.3	5.2	250		6	2.7	B8A	TT
	ECC70	852 113 480 0000	00	742 113 460		6.3	1	100		6.5	5.4	B8D	TT
	ECC81	851 228 413 0000	00	741 226 413		6.3	2	250		10	5.5	B9A	TT

SPEC.	VALVE TYPE NUMBER	PIN CONNECTIONS				CHARACTERISTICS						BASE	VALVE CLASS
		VCM163 Tester Only		CT160, VT160, VCM Mk 1,2,3,4		Vh	Vg1	Va	Vg2	la	gm mA/V		
		SELECTOR SWITCH	TOP CAP	SELECTOR SWITCH	TOP CAP	V	V	V	V	mA	†Ra MΩ		
	ECC82	851 228 413 0000	00	741 226 413		6.3	8.5	250		10.5	2.2	B9A	TT
	ECC83	851 228 413 0000	00	741 226 413		6.3	2	250		1.2	1.6	B9A	TT
	ECC84	158 234 118 0000	00	147 234 116		6.3	1.5	90		12	6	B9A	TT
	ECC85	851 238 410 0000	00	741 236 410		6.3	2.3	250		10	5.9	B9A	TT
	ECC86	841 238 510 0000	00	641 237 410		6.3	0.3	12		2.5	4.6	B9A	TT
	ECC88	841 238 510 0000	00	641 237 510		6.3	1.2	90		15	12.6	B9A	TT
	ECC89	148 235 118 0000	00	146 234 117		6.3	1.2	90		15	12	B9A	TT
ø	ECC91	882 345 100 0000	00	672 344 100		6.3	0.8	100		8.5	5.3	B7G	TT
ø	ECC91	882 345 100 0000	00	672 344 100		6.3	3	150		5	4.5	B7G	TT
	ECC171	231 488 512 0000	00	231 466 412		6.3	1.5	200		2.5	2.5	B10B	TT
	ECC180	841 238 510 0000	00	641 237 410		6.3	2	150		9	6.4	B9A	TT
	ECC186	841 228 513 0000	00	641 227 413		6.3	8.5	250		10.5	10.5	B9A	TT
	ECC189	841 328 510 0000	00	641 327 410		6.3	1.4	90		15	12.5	B9A	TT
	ECC230	481 581 230 0000	00	461 471 230		6.3	30	100		100	6.5	AO8	TT
	ECC282	841 228 513 0000	00	641 227 413		6.3	2	100		11.8	3.1	B9A	TT
	ECC801	841 228 513 0000	00	641 227 413		6.3	2	250		10	5.5	B9A	TT
	ECC802	841 228 513 0000	00	641 227 413		6.3	8.5	250		10.5	2.2	B9A	TT
	ECC803	841 228 513 0000	00	641 227 413		6.3	2	250		1.2	1.6	B9A	TT
	ECC804	841 238 510 0000	00	641 237 410		6.3	7.7	200		10	3.4	B9A	TT
	ECC807	158 231 084 0000	00	147 231 064		6.3	1.5	250		1.3	2.4	B9A	TT
	ECC808	418 230 815 0000	00	416 230 714		6.3	1.9	250		1.2	1.6	B9A	TT
	ECC813	814 228 153 0000	00	614 227 143		6.3		250		14.5	5.2	B9A	TT
	ECC865	841 238 510 0000	00	641 237 410		6.3	14	200		8.7	6	B9A	TT
	ECC960	882 345 100 0000	00	672 344 100		6.3	2.1	100		8.5	6	B7G	TT
	ECC962	882 345 100 0000	00	672 344 100		6.3	1.7	150		8.5	6	B7G	TT
	ECC2000	015 123 841 8000	00	-		6.3	1.2	90		27	22	B10B	TT
	ECC2000	015 123 841 8000	00	-		6.3	1.2	90		27	16.5	B10B	TT
	ECC8100	151 238 418 0000	00	141 237 416		6.3		100		25	16	B9A	TT
	ECC8100	151 238 418 0000	00	141 237 416		6.3		100		25	20	B9A	TT
	ECF1	023 184 780 0000	50	023 164 570	G1	6.3	3	150		8	2.2	8SC	TP
	ECF1	023 184 780 0000	50	023 164 570	G1	6.3	2	250	100	5	2.5	8SC	TP
	ECF12	842 381 570 0000	00	642 371 450		6.3		100		11	3	F8	TP
	ECF12	842 381 570 0000	00	642 371 450		6.3	2	250	100	5	2	F8	TP
	ECF80	857 238 114 0000	00	645 237 114		6.3	2	100		14	5	B9A	TP
	ECF80	857 238 114 0000	00	645 237 114		6.3	3	250	200	7	5.5	B9A	TP
	ECF82	857 238 114 0000	00	645 237 114		6.3	1	150		18	8.5	B9A	TP
	ECF82	857 238 114 0000	00	645 237 114		6.3	1	250	100	10	5.2	B9A	TP
	ECF83	148 238 715 0000	00	146 237 514		6.3	3.7	60		6.5	3.6	B9A	TP
	ECF83	148 238 715 0000	00	146 237 514		6.3		60	50	3	1.3	B9A	TP
	ECF86	151 234 887 0000	00	141 234 675		6.3	3	100		14	5.5	B9A	TP
	ECF86	151 234 887 0000	00	141 234 675		6.3	1.2	200	150	10	12	B9A	TP
	ECF174	314 818 175 0000	00	314 616 154		6.3	0	100		11	5	B10B	TP
	ECF174	314 818 175 0000	00	314 616 154		6.3	2	250	150	8	3	B10B	TP
	ECF801	151 238 784 0000	00	141 236 564		6.3	3	100		15	8.5	B9A	TP
	ECF801	151 238 784 0000	00	141 236 564		6.3	1.2	150	100	10	10	B9A	TP
	ECF802	857 238 114 0000	00	645 237 114		6.3	2	200		3.5	3.5	B9A	TP
	ECF802	857 238 114 0000	00	645 237 114		6.3	1	100	100	6	5.5	B9A	TP
	ECF804	857 238 114 0000	00	645 237 114		6.3	1.5	150		13.5	7.2	B9A	TP
	ECF804	857 238 114 0000	00	645 237 114		6.3	2	150	150	7	11	B9A	TP
	ECF805	878 231 514 0000	00	657 231 414		6.3	3	100		14	5.5	B9A	TP
	ECF805	878 231 514 0000	00	657 231 414		6.3	1.5	100	100	10	11	B9A	TP
	ECF8070	151 238 784 0000	00	141 237 564		6.3	3	100		14	5.5	B9A	TP
	ECF8070	151 238 784 0000	00	141 237 564		6.3	1.2	200	150	10	12	B9A	TP

SPEC.	VALVE TYPE NUMBER	PIN CONNECTIONS				CHARACTERISTICS						BASE	VALVE CLASS
		VCM163 Tester Only		CT160, VT160, VCM Mk 1,2,3,4		Vh	Vg1	Va	Vg2	la	gm mA/V		
		SELECTOR SWITCH	TOP CAP	SELECTOR SWITCH	TOP CAP	V	V	V	V	mA	†Ra MΩ		
	ECH2	023 184 780 0000	50	023 164 570	G1	6.3	1	100		9.5	5.5	8SC	TH
	ECH2	023 105 780 0000	50	023 164 570	G1	6.3	2.5	250	100	3.2		8SC	TH
	ECH3	023 184 080 0000	50	023 164 570	G1	6.3	2	100		5	2.4	8SC	TH
	ECH3	023 105 780 0000	50	023 164 570	G1	6.3	2	250	100	4.8	2.5	8SC	TH
	ECH3G	028 748 310 0000	50	027 546 310	G	6.3	2	100		5	1.4	AO8	TH
	ECH3G	028 750 310 0000	50	027 546 310	G	6.3	2	250	100	4.8	2.5	AO8	TH
	ECH4	023 854 780 0000	50	123 614 570	G1	6.3	2	100		6.3	2.7	8SC	TH
	ECH4	023 854 780 0000	50	123 614 570	G1	6.3	2	250	100	6.5	2.6	8SC	TH
	ECH4G	128 748 310 0000	50	127 546 310	G	6.3	2	100		6.3	2.7	AO8	TH
	ECH4G	128 748 310 0000	50	127 546 310	G	6.3	2	250	200	6.5	2.6	AO8	TH
	ECH11	842 381 570 0000	00	642 371 450		6.3	2	100		5	2.4	F8	TH
	ECH11	052 381 570 0000	00	642 371 450		6.3	2	250	100	4.7	2.5	F8	TH
	ECH21	288 475 131 0000	00	276 454 131		6.3	2	100		6.2	2.4	B8B	TH
	ECH21	288 475 131 0000	00	276 454 131		6.3	2	250	90	5.3	2.2	B8B	TH
	ECH33	028 748 310 0000	50	027 546 310	G1	5.3	2	100		5	2.4	AO8	TH
	ECH33	028 750 310 0000	50	027 546 310	G1	6.3	2	200	100	3	2.8	AO8	TH
	ECH35	028 748 310 0000	50	027 546 310	G1	6.3	2	100		5.4	2.2	AO8	TH
	ECH35	028 750 310 0000	50	027 546 310	G1	6.3	2	250	100	5	2.4	AO8	TH
	ECH41	288 475 130 0000	00	276 454 130		6.3	2	100		5	2.2	B8A	TH
	ECH41	280 575 130 0000	00	276 454 130		6.3	2	250	100	3	2	B8A	TH
	ECH42	288 475 130 0000	00	276 454 130		6.3	2	100		5	2.2	B8A	TH
	ECH42	280 575 130 0000	00	276 454 130		6.3	2	250	100	8	2	B8A	TH
	ECH71	288 475 131 0000	00	276 454 431		6.3	2	250		2		B8B	TH
	ECH71	288 475 131 0000	00	276 454 431		6.3	2	250	100	3	0.7	B8B	TH
	ECH80	051 230 084 0000	00	541 23* 674		6.3	2	75		5		B9A	TH
	ECH80	751 230 805 0000	00	541 23* 674		6.3	2	250	75	3	0.75	B9A	TH
	ECH81	751 238 084 0000	00	541 237 164		6.3	3	100		5	2.3	B9A	TH
	ECH81	751 238 084 0000	00	541 237 164		6.3	2	250	100	6.5	2.4	B9A	TH
	ECH83	751 238 084 0000	00	541 237 164		6.3	0.25	12		0.7	1.4	B9A	TH
	ECH83	751 238 084 0000	00	541 237 164		6.3	0.5	12	12	0.4	0.7	B9A	TH
	ECH84	551 238 784 0000	00	441 237 564		6.3	0	50		3.0	3.7	B9A	TP
	ECH84	551 238 784 0000	00	441 237 564		6.3	0	150	14	1.7	2.2	B9A	TP
	ECH113	288 475 130 0000	00	276 454 130		6.3	2	100		4.8		B8A	TH
	ECH113	280 575 130 0000	00	276 454 130		6.3		250	90	3		B8A	TH
	ECH171	842 751 381 0000	00	642 544 371		6.3		250		3		B8B	TH
	ECH171	842 751 381 0000	00	642 544 371		6.3	2	250	75	2	0.7	B8B	TH
	ECH200	114 723 851 8000	00	114 523 651		6.3	1	100		9.5	8.5	B10B	TP
	ECH200	114 723 851 8000	00	114 523 651		6.3		12.6	12.6	0.8		B10B	TP
	ECH8000	751 238 084 0000	00	541 237 464		6.3	1.5	100		11	4.2	B9A	TH
	ECH8000	751 238 084 0000	00	541 237 464		6.3	1.5	250	100	9	5	B9A	TH
	ECL11	572 381 480 0000	00	452 371 460		6.3	2.5	250		2	2	F8	TP
	ECL11	572 381 480 0000	00	452 371 460		6.3	6	250	250	36	9	F8	TP
	ECL80	841 238 175 0000	00	641 237 154		6.3	2.3	100		4	1.4	B9A	TP
	ECL80	841 238 175 0000	00	641 237 154		6.3	8	200	200	17.5	3.3	B9A	TP
	ECL81	471 238 815 0000	00	451 237 614		6.3	1.9	150		1.3	1.6	B9A	TH
	ECL81	471 238 815 0000	00	451 237 614		6.3	5.5	250	250	36	8.7	B9A	TH
	ECL82	415 238 718 0000	00	414 237 516		6.3	1	200		3.7	2.4	B9A	TP
	ECL82	415 238 718 0000	00	414 237 516		6.3	16	200	200	35	6.4	B9A	TP
	ECL83	841 238 175 0000	00	641 237 154		6.3	1.5	200		1.6	2.5	B9A	TP
	ECL83	841 238 175 0000	00	641 237 154		6.3	9.5	200	175	30	5.5	B9A	TP
	ECL84	481 238 157 0000	00	461 237 145		6.3	1.7	200		3	4	B9A	TP
	ECL84	481 238 157 0000	00	461 237 145		6.3	2.0	175	175	18	10.4	B9A	TP
	ECL85	841 238 715 0000	00	641 237 514		6.3	0.8	100		5	6.5	B9A	TP
	ECL85	841 238 715 0000	00	641 237 514		6.3	15	200	175	41	7.5	B9A	TP

SPEC.	VALVE TYPE NUMBER	PIN CONNECTIONS				CHARACTERISTICS						BASE	VALVE CLASS
		VCM163 Tester Only		CT160, VT160, VCM Mk 1,2,3,4		Vh	Vg1	Va	Vg2	la	gm mA/V		
		SELECTOR SWITCH	TOP CAP	SELECTOR SWITCH	TOP CAP	V	V	V	V	mA	†Ra MΩ		
	ECL86	517 238 148 0000	00	415 237 146		6.3	1.9	250		1.2	1.6	B9A	TP
	ECL86	517 238 148 0000	00	415 237 146		6.3	7	250	250	36	10	B9A	TP
	ECL113	288 574 130 0000	00	267 454 130		6.3	1	150		2	1.6	B8A	TP
	ECL113	288 574 130 0000	00	267 454 130		6.3	3.5	250	250	25	8.5	B8A	TP
	ECLL800	840 235 180 0000	00	647 234 1†5		6.3	9.0	100		4	0.05	B9A	TPP
	ECLL800	048 235 187 0000	00	647 234 1†5		6.3	9.0	250	250	26	6.0	B9A	TPP
	ED111	288 104 430 0000	00	266 104 430		6.3	5	200		40	8	B8A	T
	EDD11	852 301 480 0000	00	742 310 460		6.3	8	200		3.5		F8	TT
	EDD111	852 311 480 0000	00	742 311 460		6.3	8	250		9	2.3	F8	TT
	EDD171	231 488 512 0000	00	231 466 412		6.3	3.5	150		14	4.8	B10B	TT
	EE1	023 190 780 0000	00	023 180 560		6.3	2.5	250	150	8	14	F8	DP
	EE50	278 701 403 0000	00	256 501 403		6.3	3	250	250	10	14	B9G	P
	EE80	041 231 870 0000	00	*41 231 650		6.3		200	200	10	12.5	B9A	P
	EEL71	285 774 831 0000	00	274 554 631		6.3	6.5	250	250	24	6.5	B9G	PP
	EEL171	752 874 381 0000	00	542 654 371		6.3	12	250	250	40	9	B8B	PP
	EEL171	752 874 381 0000	00	542 654 371		6.3	2	100	50	3		B8B	PP
	EEL171	218 000 300 0000	40	216 000 300	G1	6.3	12	250	250	40	9	B7	T
	EEL171	038 090 200 0000	00	036 080 200		6.3	2	100	50	2		AO8	DT
	EEP1	023 190 780 0000	40	023 180 560	G1	6.3	2.5	250	150	8	17	8SC	DP
	EEP71	023 110 780 0000	40	023 110 560	G1	6.3	3	250	100	8	2.2	8SC	P
	EF2	023 110 780 0000	40	023 110 560	G1	6.3	2	250	100	4.5	2.2	8SC	P
	EF2S	023 110 780 0000	40	023 110 560	G1	6.3	2	250	100	5	1.8	8SC	P
	EF3	023 110 780 0000	40	023 110 560	G1	6.3	2.5	250	100	8	1.8	8SC	P
	EF5	023 110 780 0000	40	023 110 560	G1	6.3	3	250	100	8	1.7	8SC	P
	EF6	023 110 780 0000	40	023 110 560	G1	6.3	2	250	100	3	2	8SC	P
	EF7	023 110 780 0000	40	023 110 560	G1	6.3	1.5	250	100	3	2.1	8SC	P
	EF8	023 111 780 0000	40	023 111 560	G1	6.3	2.5	250	250	8	1.8	8SC	P
	EF9	023 110 780 0000	40	023 110 560	G1	6.3	2.5	250	100	6	2.2	8SC	P
	EF11	802 301 470 0000	00	602 301 450		6.3	2	250	100	6	2.2	F8	P
	EF12	802 301 470 0000	00	602 301 450		6.3	2	250	100	3	2.1	F8	P
	EF12spec.	802 301 470 0000	00	602 301 450		6.3	2	250	100	3	1.7	F8	P
	EF13	812 301 470 0000	00	612 301 450		6.3	2	250	100	4.5	2.3	F8	P
	EF14	812 370 140 0000	00	612 350 140		6.3	4.5	200	200	12	7	F8	P
	EF15	812 301 470 0000	00	612 301 450		6.3	2	250	100	12	5.5	F8	P
	EF22	287 104 130 0000	00	265 104 130		6.3	2.5	250	100	6	2.2	B8B	P
	EF25	023 110 780 0000	40	023 110 560	G1	6.3	2	250	100	5	1.8	8SC	P
	EF36	028 710 310 0000	40	026 510 310	G1	6.3	2	250	100	3	1.8	AO8	P
	EF38	128 710 310 0000	40	126 510 310	G1	6.3	2.5	250	250	8	1.8	AO8	P
	EF39	028 710 310 0000	40	026 510 310	G1	6.3	2.5	250	100	6	2.2	AO8	P
	EF40	280 147 130 0000	00	26* 145 130		6.3	2	250	150	3	1.8	B8B	P
	EF41	281 174 130 0000	00	261 154 130		6.3	2.5	250	100	6	2.2	B8A	P
	EF42	280 174 130 0000	00	260 154 130		6.3	2	250	250	10	9.5	B8A	P
	EF43	280 174 130 0000	00	260 154 130		6.3	2	250	150	15	6.4	B8A	P
	EF44	280 147 130 0000	00	260 145 130		6.3	2	250	150	3	1.8	B8A	P
	EF50	278 101 403 0000	00	256 101 403		6.3	1.5	250	250	10	6.5	B9G	P
	EF51	281 174 130 0000	00	261 154 130		6.3	2	250	250	14	9.5	B8B	P
	EF52	281 174 130 0000	00	261 154 130		6.3	2	250	250	10	10	B8G	P
	EF53	278 101 403 0000	00	256 101 403		6.3	2	250	250	10	6.5	B9G	P
	EF54	287 114 113 0000	00	265 114 113		6.3	1.7	250	250	10	7.7	B9G	P
	EF55	278 101 403 0000	00	256 101 403		6.3	4	250	150	10	7	B9G	P
	EF70	412 183 710 0000	00	412 163 510		6.3	2	100	100	13	5.5	B8D	P

SPEC.	VALVE TYPE NUMBER	PIN CONNECTIONS				CHARACTERISTICS						BASE	VALVE CLASS
		VCM163 Tester Only		CT160, VT160, VCM Mk 1,2,3,4		Vh	Vg1	Va	Vg2	la	gm mA/V		
		SELECTOR SWITCH	TOP CAP	SELECTOR SWITCH	TOP CAP	V	V	V	V	mA	†Ra MΩ		
	EF71	412 183 710 0000	00	412 163 510		6.3	2	100	100	13	5.5	B8D	P
	EF72	412 183 710 0000	00	412 163 510		6.3	1.4	100	100	7	5	B8D	P
	EF73	412 873 180 0000	00	412 653 160		6.3	2	100	100	7.5	5.5	B8D	P
	EF74	412 873 180 0000	00	412 653 160		6.3	1.4	100	100	7	3.1	B8D	P
	EF80	141 230 871 0000	00	141 230 651		6.3	2	200	175	10	7.2	B9A	P
	EF81	741 238 000 0000	00	541 236 000		6.3	2.5	250	125	6	2.2	B9A	P
	EF82	041 230 871 0000	00	*41 230 651		6.3	4.5	250	250	40	11	B9A	P
	EF83	701 238 014 0000	00	501 236 014		6.3	1.6	250	50	4	1.6	B9A	P
	EF85	141 230 871 0000	00	141 230 651		6.3	2	250	100	10	6	B9A	P
	EF86	701 238 014 0000	00	501 236 014		6.3	2	250	150	3	2.3	B9A	P
	EF87	701 238 014 0000	00	501 236 014		6.3	2	250	100	3.3	1.9	B9A	P
	EF88	701 238 014 0000	00	501 236 014		6.3	2	250	100	7	2.1	B9A	P
	EF89	041 230 871 0000	00	041 230 651		6.3	2	250	100	9	3.6	B9A	P
	EF89F	041 230 871 0000	00	041 230 651		6.3	20	250	100	11	4.4	B9A	P
	EF91	412 381 700 0000	00	412 361 500		6.3	2	250	250	10	7.6	B7G	P
	EF92	412 381 700 0000	00	412 361 500		6.3	2.5	250	200	8	2.5	B7G	P
	EF93	412 387 100 0000	00	412 365 100		6.3	1	250	100	11.6	4.5	B7G	P
	EF94	412 387 100 0000	00	412 365 100		6.3	1	250	150	10.6	5.2	B7G	P
	EF95	412 387 100 0000	00	412 365 100		6.3	2.3	150	150	7	4.3	B7G	P
	EF96	412 387 100 0000	00	412 365 100		6.3	1.5	250	150	6.5	5	B7G	P
	EF97	412 387 100 0000	00	412 365 100		6.3	0.7	12	12			B7G	P
	EF98	412 387 100 0000	00	412 365 100		6.3	1	12	12	4.8	3	B7G	P
	EF111	812 370 140 0000	00	612 350 140		6.3	2	250	75	6	2.2	F8	P
	EF112	812 370 140 0000	00	612 350 140		6.3	2	250	100	3	2.1	F8	P
	EF172	112 740 380 0000	00	112 540 360		6.3	2	250	100	5	3	B8A	P
	EF174	112 740 380 0000	00	112 540 360		6.3	3.5	200	200	12	9	B8A	P
	EF175	112 740 380 0000	00	112 540 360		6.3	2.1	250	100	12	4.5	B8A	P
	EF183	141 230 871 0000	00	141 230 651		6.3	2	200	90	12	12.5	B9A	P
	EF184	141 230 871 0000	00	141 230 651		6.3	2.5	200	200	10	15	B9A	P
	EF186	841 230 871 0000	00	641 230 651		6.3	0.5	200	50			B9A	P
	EF190	412 387 100 0000	00	412 365 100		6.3	2	200	150	8.5	6.2	B7G	P
	EF410	280 074 130 0000	00	26* *54 130		6.3	2	250	100	6	2.7	B8A	P
	EF730	782 803 180 0000	00	562 603 160		6.3	1	100	100	5.3	3.2	B8D	P
	EF731	412 183 710 0000	00	412 163 510		6.3	1.1	100	100	7.2	4.5	B8D	P
	EF732	412 183 710 0000	00	412 163 510		6.3	1.5	100	100	7.5	5	B8D	P
	EF734	412 183 710 0000	00	412 163 510		6.3	1.5	100	100	7.5	5	B8D	P
	EF800	141 230 871 0000	00	141 230 651		6.3	2	200	175	10	7.2	B9A	P
	EF802	141 230 870 0000	00	141 23* 65*		6.3	1.8	200	175	12	8	B9A	P
	EF804	101 230 874 0000	00	101 230 654		6.3	2	250	150	3	2	B9A	P
	EF805S	141 230 871 0000	00	141 230 651		6.3	1.8	250	75	8	5.7	B9A	P
	EF806S	701 238 014 0000	00	501 236 014		6.3		250	150	3.2	2	B9A	P
	EF811	141 237 890 0000	00	141 230 650		6.3	1.5	200	90	11.5	12.5	B9A	DP
	EF812	141 230 871 0000	00	141 230 651		6.3	1.6	150	150	10	9.2	B9A	P
	EF814	141 230 871 0000	00	141 230 651		6.3	1.9	150	150	10	15	B9A	P
	EF860	141 230 871 0000	00	141 230 651		6.3		250	250	10	6.8	B9A	P
	EF861	141 230 817 0000	00	141 230 615		6.3	1.1	200	150	13	16.5	B9A	P
	EF866	701 238 014 0000	00	501 236 014		6.3	2	250	150	3	2	B9A	P
	EF905	412 387 100 0000	00	412 365 100		6.3	2	150	125	7.5	5	B7G	P
	EF8010	141 230 871 0000	00	141 230 651		6.3	2	200	100	12	12.5	B9A	P
	EF8200	141 237 817 0000	00	141 235 615		6.3		200	150	22	35	B9A	P

SPEC.	VALVE TYPE NUMBER	PIN CONNECTIONS				CHARACTERISTICS						BASE	VALVE CLASS
		VCM163 Tester Only		CT160, VT160, VCM Mk 1,2,3,4		Vh	Vg1	Va	Vg2	la	gm mA/V		
		SELECTOR SWITCH	TOP CAP	SELECTOR SWITCH	TOP CAP	V	V	V	V	mA	†Ra MΩ		
	EFF50	287 415 783 0000	00	265 414 573		6.3	2	250	200	6	8	B9G	PP
	EFL200	517 823 147 8000	00	-		6.3	2.6	175	175	30	21	B10B	PP
	EFL200	517 823 147 8000	00	-		6.3	2.3	150	150	10	8.5	B10B	PP
	EFM1	023 114 780 0000	00	023 114 560		6.3	2	250	100	1.3		8SC	TP
	EFP20	278 147 130 0000	00	256 145 130		6.3	2	250	200	5	12	B8G	P
	EFP60	214 178 183 0000	00	214 156 163		6.3	2	250	150	20	25	B9G	P
	EG420	902 300 000 0000	00	802 300 000		4				120		B4	R
	EH1	023 147 780 0000	40	023 145 560	G1	6.3	2	250	80	3	1.8	8SC	P
	EH2	023 117 780 0000	40	023 115 560	G1	6.3	3	250	100	4.2	1.4	8SC	P
	EH90	412 387 100 0000	00	412 365 100		6.3	1	100	30	1	1.1	B7G	H
	EH900	412 387 100 0000	00	412 365 100		6.3	0	150	80	1	1.1	B7G	H
	EH900S	412 387 100 0000	00	412 365 100		6.3	10	150	75	0.2		B7G	H
	EK1	123 184 7X0 0000	00	123 164 570	G1	6.3	1.5	90		2		8SC	O
	EK1	123 184 7X0 0000	00	123 164 570	G1	6.3	8.5	250	75	1.6		8SC	O
	EK2	023 174 780 0000	40	023 154 560	G1	6.3	2	250	75	2.8	1.8	8SC	O
	EK2G	028 747 310 0000	00	026 545 310		6.3	2	250	75	2.7	1.8	AO8	O
	EK3	023 174 780 0000	40	023 154 560	G1	6.3	2	100	60	11	3.8	8SC	O
	EK32	028 747 310 0000	40	026 545 310	G1	6.3	2	250	75	1.5	1.5	AO8	O
	EK90	112 387 400 0000	00	112 365 400		6.3	1.5	250	100	3	.47	B7G	H
	EL1	023 100 780 0000	40	023 100 560	G1	6.3	18.5	250	250	32	2.6	8SC	P
	EL3	023 104 780 0000	00	023 104 560		6.3	6	250	250	36	9	8SC	P
	EL3/425	023 104 780 0000	00	023 104 560		6.3	15.6	400	300	25	3	8SC	P
	EL3NG	028 740 310 0000	00	026 540 310		6.3	6	250	250	36	9	AO8	P
	EL5	023 104 780 0000	00	023 104 560		6.3	14	250	275	72	8.5	8SC	P
	EL5/375	023 140 780 0000	00	023 140 560		6.3	14	250	275	72	8.5	8SC	P
	EL5/600	023 114 700 0000	80	023 114 500	A1	6.3		250	275	72	8.5	8SC	P
	EL5G	028 740 310 0000	00	026 540 310		6.3	14	250	275	72	8.5	AO8	P
	EL6	023 104 780 0000	00	023 104 560		6.3	7	250	250	72	14.5	8SC	P
	EL6/435	023 104 780 0000	00	023 104 560		6.3	7.5	250	250	20	5.5	8SC	P
	EL6spec.	023 104 780 0000	00	023 104 560		6.3	7	250	250	72	14.5	8SC	P
	EL11	802 301 470 0000	00	602 301 450		6.3	6	250	250	36	9	F8	P
	EL12	802 301 450 0000	00	602 301 450		6.3	7	250	250	72	15	F8	P
	EL12/325	802 301 470 0000	00	602 301 450		6.3	7	250	250	72	18	F8	P
	EL12/375	802 301 470 0000	00	602 301 450		6.3	7	400	250	72	15	F8	P
	EL12spec	702 301 400 0000	80	502 301 400	A1	6.3	19	400	350	42	10	F8	P
	EL13	802 310 470 0000	00	602 310 450		6.3	7.5	250	250	20	5.5	F8	P
	EL20	287 104 130 0000	00	265 104 130		6.3	34	300	300	12.5	3.7	B8B	P
	EL22	287 004 130 0000	00	265 004 130		6.3	7	250	250	44	9.5	B8B	P
	EL30	028 741 310 0000	00	026 541 310		6.3	4.5	250	250	18	6.5	AO8	P
	EL31	120 740 310 0000	80	120 540 310	A1	6.3	9	300	275	91	14	AO8	P
	EL32	028 700 310 0000	40	026 500 310	G1	6.3	18	250	250	32	2.8	AO8	P
	EL33	028 740 310 0000	00	026 540 310		6.3	6	250	250	36	9	AO8	P
	EL34	128 740 310 0000	00	126 540 310		6.3	13.5	250	250	75	11	AO8	P
	EL35	028 740 310 0000	00	026 540 310		6.3	15.5	250	250	72	5	AO8	P
	EL36	020 740 310 0000	80	020 540 310	A1	6.3	7	250	250	72	14	AO8	P
	EL37	020 740 310 0000	00	020 540 310		6.3	13.5	250	250	100	11	AO8	P
	EL38	120 740 310 0000	80	120 540 310	A1	6.3	7	250	250	89	14.3	AO8	P
	EL39	020 741 310 0000	80	020 541 310	A1	6.3	3.2	200	125	45	6.5	AO8	P
	EL41	280 074 130 0000	00	26* *54 130		6.3	7	250	250	36	10	B8A	P
	EL42	281 074 130 0000	00	261 054 130		6.3	10.8	225	225	26	3.2	B8A	P

SPEC.	VALVE TYPE NUMBER	PIN CONNECTIONS				CHARACTERISTICS						BASE	VALVE CLASS
		VCM163 Tester Only		CT160, VT160, VCM Mk 1,2,3,4		Vh	Vg1	Va	Vg2	la	gm mA/V		
		SELECTOR SWITCH	TOP CAP	SELECTOR SWITCH	TOP CAP	V	V	V	V	mA	†Ra MΩ		
EL43	280 174 130 0000	00		250 154 130		6.3	3	250	250	36	10	B8A	P
EL44	200 174 130 0000	80		200 154 130	A1	6.3	22.5	250	250	20	5	B8A	P
EL50	023 114 700 0000	80		023 114 500	A1	6.3	14	250	275	72	8.5	8SC	P
EL51	023 104 700 0000	80		023 104 500	A1	6.3	30	400	300	44	7	8SC	P
EL53	023 104 780 0000	00		023 104 560		6.3	7.7	400	250	24	8	8SC	P
EL54	023 140 780 0000	00		023 140 560		6.3	12.2	300	300	55	13	8SC	P
EL60	218 007 413 0000	00		216 005 413		6.3	14.5	250	250	67	9	B9G	P
EL70	412 183 710 0000	00		412 163 510		6.3	9	100	100	31	2.2	B8D	P
EL71	412 183 710 0000	00		412 163 510		6.3	8.5	100	100	30	4	B8D	P
EL80	741 230 800 0000	00		541 230 600		6.3	6.5	250	250	36	10	B9A	P
EL81	041 230 071 0000	80		*41 23* *51	A1	6.3	38.5	250	250	32	4.6	B9A	P
EL81F	041 230 070 0000	80		041 230 050	A1	6.3	28	200	200	40	6	B9A	P
EL82	041 230 807 0000	00		*41 23* 6*5		6.3	10.4	200	200	54	9	B9A	P
EL83	741 230 800 0000	00		541 23* 600		6.3	5.5	250	250	36	10	B9A	P
EL84	041 230 807 0000	00		*41 23* 6*5		6.3	7.3	250	250	48	11.3	B9A	P
EL85	441 231 817 0000	00		441 231 615		6.3	10.8	250	225	26	3.2	B9A	P
EL86	041 230 807 0000	00		*41 23* 6*5		6.3	12.5	200	175	70	10	B9A	P
EL86F	041 230 807 0000	00		*41 23* 6*5		6.3	12.5	200	200	70	10	B9A	P
EL88	041 230 871 0000	00		041 230 651		6.3	4.5	200	200	33	9.7	B9A	P
EL89	041 230 871 0000	00		041 230 651		6.3	6	250	250	38	10.5	B9A	P
EL90	412 387 400 0000	00		412 365 400		6.3	12.5	250	250	45	4.1	B7G	P
EL91	412 380 700 0000	00		412 360 500		6.3	13.8	250	250	16	2.6	B7G	P
EL95	412 387 400 0000	00		412 365 400		6.3	9	250	250	24	5	B7G	P
EL131	128 740 310 0000	00		126 54* 310		6.3	12	250	250	100	11	AO8	P
EL150	802 301 470 0000	00		602 301 450		6.3	7	350	250	95	6.5	F8	P
EL171	102 741 380 0000	00		102 541 360		6.3	12	250	250	40	9	B8A	P
EL172	102 741 380 0000	00		102 541 360		6.3	7	250	250	72	15	B8A	P
EL180	141 223 871 0000	00		141 223 651		6.3	2	250	150	25	12	B9A	P
EL183	141 228 713 0000	00		141 226 513		6.3	2.1	200	200	40	25	B9A	P
EL300	721 441 370 0000	80		541 441 350	A1	6.3	22.5	200	150	100	10	B8A	P
EL360	020 740 310 0000	80		*2* 540 310	A1	6.3	7.7	100	100	100	14	AO8	P
EL500	441 237 710 0000	80		441 235 51*	A1	6.3	20	150	150	70	10	B9D	P
EL502	441 237 710 0000	80		441 235 510	A1	6.3	35	200	200	100	2	B9D	P
EL503	714 231 408 0000	00		514 231 406		6.3	13.2	250	250	100	23	B9D	P
EL504	441 237 710 0000	00		441 235 510	A1	6.3	20	150	150	70	10	B9A	P
EL505	417 237 141 0000	80		415 235 141	A1	6.3	40	150	150	60	8	B9D	P
EL506	741 234 708 0000	00		541 234 5*6		6.3	10	300	300	60	10.2	B9D	P
EL803	741 231 800 0000	00		541 231 600		6.3	3.5	200	200	36	10	B9A	P
EL803S	741 321 800 0000	00		541 321 600		6.3	3.5	200	200	32	10	B9A	P
EL804	041 230 007 0000	80		041 230 005	A1	6.3	12	200	175	70	10	B9A	P
EL820	041 230 071 0000	80		*41 23* *51	A1	6.3	38.5	250	250	32	4.6	B9A	P
EL821	041 230 871 0000	00		*41 23* 651		6.3	4.5	250	250	40	11	B9A	P
EL822	041 230 871 0000	00		*41 23* 651		6.3	2.5	250	150	40	13	B9A	P
EL861	041 230 871 0000	00		041 230 651		6.3		200	200	20	11	B9A	P
EL863	741 231 800 0000	00		541 231 600		6.3	5.5	250	250	36	11	B9A	P
EL3010	231 147 210 0000	80		231 145 210	A1	6.3		350	100	100	60	AO8	P
EL5070	017 231 141 0000	80		*15 231 141	A1	6.3	3	125	125	50	45	B9D	P
EL8000	141 237 817 0000	00		141 235 615		6.3		250	250	48	50	B9A	P
ELL1	523 184 780 0000	00		423 174 560		6.3	20	250	250	15	1.7	8SC	PP
ELL80	748 235 187 0000	00		546 234 175		6.3	9.0	250	250	24	6.0	B9A	PP

SPEC.	VALVE TYPE NUMBER	PIN CONNECTIONS				CHARACTERISTICS						BASE	VALVE CLASS
		VCM163 Tester Only		CT160, VT160, VCM Mk 1,2,3,4		Vh	Vg1	Va	Vg2	la	gm mA/V		
		SELECTOR SWITCH	TOP CAP	SELECTOR SWITCH	TOP CAP	V	V	V	V	mA	†Ra MΩ		
	ELP71	023 104 780 0000	00	023 104 560		6.3	7	250	250	36	9	8SC	P
	ELP72	023 100 780 0000	40	023 100 560	G1	6.3	17	250	250	36	2.5	8SC	P
	EM1	023 104 780 0000	00	023 104 560		6.3	5	250	250	0.1	†2.0	8SC	TI
	EM2	023 104 780 0000	00	023 104 560		6.3	4	250	250	0.1	†2.0	8SC	-
	EM3	023 104 780 0000	00	023 104 560		6.3	18	200	200	0.2	†1.0	8SC	TI
	EM4	023 184 780 0000	00	023 164 560		6.3	4.2	200	200		†1.0	8SC	TI
	EM4	023 184 780 0000	00	023 164 560		6.3	12.5	200	200		†1.0	8SC	TI
	EM11	028 748 310 0000	00	026 546 310		6.3	5	250	250		†1.0	AO8	TI
	EM11	028 748 310 0000	00	026 546 310		6.3	16	250	250		†1.0	AO8	TI
	EM31	028 740 310 0000	00	026 540 310		6.3	5	250	250	0.1	†2.0	AO8	TI
	EM34	028 478 310 0000	00	026 456 310		6.3	4.2	250	250		†1.0	AO8	TI
	EM34	028 478 310 0000	00	026 456 310		6.3	12.5	250	250	1	†1.0	AO8	TI
	EM35	028 740 310 0000	00	026 540 310		6.3	22	250	250		†1.0	AO8	TI
	EM71	271 084 130 0000	00	251 064 130		6.3	20	250	250	0.5		B8B	TI
	EM72	271 084 130 0000	00	251 064 130		6.3	20	250	250	0.5		B8B	-
	EM80	410 230 807 0000	00	41* 23* 6*5		6.3	14	250	250	0.4	†0.5	B9A	TI
	EM81	410 230 807 0000	00	41* 23* 6*5		6.3	10.5	250	250	0.4	†0.5	B9A	TI
	EM84	401 237 808 0000	00	4*1 235 6*6		6.3	22	250	250	0.5	†0.5	B9A	TI
	EM87	401 237 808 0000	00	4*1 235 6*6		6.3	14	250	250	1.1	†1.0	B9A	TI
	EM840	401 237 808 0000	00	4*1 235 6*6		6.3	22	250	250	0.5	†0.5	B9A	TI
	EMG1	472 381 100 0000	00	452 361 100		6.3	4.5	20	20	7	4	B7G	P
	EQ80	741 238 114 0000	00	541 236 114		6.3	1	250	20	0.9	0.7	B9A	N
	ER4	002 300 000 0000	90	002 300 000	D1	4				3		B4	D
	EW60	290 000 103 0000	00	280 000 103		6.3				120		B9G	R
	EY51	023 000 000 0000	90	023 000 000	D1	6.3				3		D	-
	EY70	092 013 090 0000	00	082 813 080		6.3				30		B8D	R
	EY80	001 230 009 0000	00	**1 23* **8		6.3				120		B9A	R
	EY81	000 230 009 0000	10	*** 23* **8	C	6.3				120		B9A	R
	EY82	001 230 009 0000	00	**1 23* **8		6.3				180		B9A	R
	EY83	000 230 009 0000	10	*** 23* **8	C	6.3						B9A	D
	EY84	001 230 000 0000	90	**1 23* ***	D1	6.3				120		B9A	R
	EY86	230 232 032 0000	90	23* 232 *32	D1	6.3				0.8		B9A	D
	EY87	230 232 032 0000	90	23* 232 *32	D1	6.3				0.8		B9A	D
	EY88	000 230 009 0000	10	*** 23* **8	C1	6.3				120		B9A	R
	EY89	001 230 009 0000	00	**1 23* **8		6.3				120		B9A	R
	EY91	912 390 000 0000	00	812 380 000		6.3				60		B7G	R
	EY92	002 390 100 0000	00	002 380 100		6.3				60		B7G	R
	EY500	090 230 990 0000	10	-		6.3				180		B9D	R
	EY3000	023 100 000 0000	90	023 100 000	D1	6.3				120		8SC	R
	EY3000N	023 100 000 0000	90	023 100 000	D	6.3				120		8SC	R
	EYY13	230 239 0X0 0000	00	230 238 090		6.3				120		F8	RR
	EZ1	023 190 0X0 0000	00	023 180 090		6.3				30		8SC	RR
	EZ3	023 190 0X0 0000	00	023 180 090		6.3				60		8SC	RR
	EZ11	X02 300 190 0000	00	902 300 180		6.3				30		F8	RR
	EZ12	X02 300 190 0000	00	902 300 180		6.3				60		F8	RR
	EZ22	209 00X 130 0000	00	208 009 130		6.3				60		B8B	RR
	EZ33	029 0X0 310 0000	00	028 090 310		6.3				60		AO8	RR
	EZ35	029 0X0 310 0000	00	028 090 310		6.3				30		AO8	RR
	EZ40	290 00X 130 0000	00	280 *09 130		6.3				30		B8A	RR
	EZ80	901 230 X00 0000	00	9*1 23* 8**		6.3				30		B9A	RR



SPEC.	VALVE TYPE NUMBER	PIN CONNECTIONS				CHARACTERISTICS						BASE	VALVE CLASS
		VCM163 Tester Only		CT160, VT160, VCM Mk 1,2,3,4		Vh	Vg1	Va	Vg2	la	gm mA/V		
		SELECTOR SWITCH	TOP CAP	SELECTOR SWITCH	TOP CAP	V	V	V	V	mA	†Ra MΩ		
	EZ81	X01 230 900 0000	00	9*1 23* 8**		6.3				60		B9A	RR
	EZ82	X01 230 900 0000	00	9*1 23* 8**		6.3				30		B9A	RR
	EZ90	902 30X 100 0000	00	802 309 100		6.3				30		B7G	RR
	EZ900	902 30X 100 0000	00	802 309 100		6.3				30		B7G	RR
	F2A11	802 301 470 0000	00	602 301 450		6.3	6.5	250	250	100	18	F8	P
	F5	842 300 000 0000	00	642 300 000		4	40	300		40	6	B4	T
	F10	842 300 000 0000	00	642 300 000		4	15	300		30	5.5	B4	T
	F100	842 370 000 0000	00	642 350 000		4	16	250	250	42	2.5	B5	P
	F109	284 300 000 0000	00	264 300 000		1.5	14.5	200		6.2	11.5	UX4	T
	F109A	284 300 000 0000	00	642 300 000		1.5	14.5	200		6.2	1.2	B5	T
	F109A	842 300 000 0000	00	264 300 000		1.5	14.5	200		6.3	1.2	UX4	T
	F203	842 300 000 0000	00	264 300 000		2.5	50	300		36	2	UX4	T
	F203	284 300 000 0000	00	642 300 000		2.5	56	300		36	2	B4	P
	F209	842 300 000 0000	00	642 300 000		2.5	21	250		5.2	0.9	B4	T
	F209	284 300 000 0000	00	264 300 000		2.5	21	250		5.2	0.9	UX4	T
	F209A	842 310 000 0000	00	642 310 000		2.5	21	250		5	1	B5	T
	F215	284 130 000 0000	00	264 130 000		2.5	6	150		6.5	2	UX5	T
	F215	842 310 000 0000	00	642 310 000		2.5	6	150		6.5	2	B5	T
	F242	287 130 000 0000	40	265 130 000	G1	2.5	1.3	200	100	1.5	0.9	UX5	P
	F410	842 300 000 0000	00	642 300 000		4	15	300		13.5	2.8	B4	T
	F443	842 370 000 0000	00	642 350 000		4	30	400	200	45	3.2	B5	P
	F460	842 310 000 0000	00	642 310 000		4	2	250		10	5.5	B5	T
	F704	842 300 000 0000	00	642 300 000		7.5	84	400		55	2.1	B5	T
	F707	842 300 000 0000	00	642 300 000		7.5	84	400		55	2.1	B4	T
	F707	284 300 000 0000	00	264 300 000		7.5	84	400		55	2.1	UX4	T
	F708	284 300 000 0000	00	264 300 000		7.5	44	400		16	1.6	UX4	T
	F/7001	412 387 100 0000	00	412 365 100		6.3		150	125	35	4.8	B7G	P
	FC2	845 230 X00 0000	40	645 230 700	G1	2		150	50	2		B7	O
	FC2	845 230 X00 0000	40	645 230 700	G1	2		150	75	0.9	0.2	B7	O
	FC2A	845 230 X00 0000	40	645 230 700	G1	2		150	50	1.2		B7	O
	FC2A	845 230 X00 0000	40	645 230 700	G1	2		150	50	0.7	0.3	B7	O
	FC4	845 231 X00 0000	40	645 231 700	G1	4	4	90	90	2	1	B7	O
	FC4	845 231 X00 0000	40	645 231 700	G1	4	4	250	90	1.6	1	B7	O
	FC13	023 184 7X0 0000	40	023 164 570	G1	13	3	90	75	2	1.3	8SC	O
	FC13	023 184 7X0 0000	40	023 164 570	G1	13	2	200	75	2.6	0.6	8SC	O
	FC13C	845 231 X00 0000	40	645 231 700	G1	13	3	90	75	2	1.3	B7	O
	FC13C	845 231 X00 0000	40	645 231 700	G1	13	2	200	75	2.6		B7	O
	FC141	20X 840 730 0000	40	207 640 530	G1	1.4		90	90	0.5		M08	H
	FH2118	187 472 300 0000	40	165 452 300	G1	20	2	200	80	3		C7	P
	FT4	028 740 310 0000	00	026 540 310		4	6	250	250	0.5	†1.0	AO8	TI
	FW1	9X3 200 000 0000	00	893 200 000		4				30		B4	RR
	FW3	9X2 300 000 0000	00	892 300 000		4				60		B4	RR
	FW4/500	9X2 300 000 0000	00	982 300 000		4				120		B5	RR
	FW4/800	X92 300 000 0000	00	982 300 000		4				60		B5	RR
	FY	842 370 000 0000	00	642 350 000		4	10	250	250	32	5	B5	P
	FZ1	023 190 0X0 0000	00	023 180 090		13				30		8SC	RR
	G	284 300 000 0000	00	264 300 000		5	3	200		0.2		UX4	T
	G/6C4	802 384 100 0000	00	602 364 100		6.3	8.5	250		10.5	2.2	B7G	T
	G/25L6	028 740 310 0000	00	026 540 310		25	8.2	200	125	46	8	AO8	P
	G/50C5	142 347 800 0000	00	142 345 600		50	7.5	150	100	49	7.5	B7G	P
	G84	290 300 000 0000	00	280 300 000		2.5				60		UX4	R

SPEC.	VALVE TYPE NUMBER	PIN CONNECTIONS				CHARACTERISTICS						BASE	VALVE CLASS
		VCM163 Tester Only		CT160, VT160, VCM Mk 1,2,3,4		Vh	Vg1	Va	Vg2	la	gm mA/V		
		SELECTOR SWITCH	TOP CAP	SELECTOR SWITCH	TOP CAP	V	V	V	V	mA	†Ra MΩ		
	G407	842 300 000 0000	00	642 300 000		4	4	150		4	1.3	B4	T
	G431	9X2 300 000 0000	00	892 300 000		4				30		B5	RR
	G459	023 090 0X0 0000	00	023 080 090		4				60		8SC	RR
	G460	9X2 300 000 0000	00	892 300 000		4				60		B4	RR
	G470	9X2 300 000 0000	00	892 300 000		4				30		B4	RR
	G504	9X2 300 000 0000	00	892 300 000		4				15		B4	RR
	G660	023 1X0 090 0000	00	023 190 080		6.3				30		8SC	RR
	G715	902 300 000 0000	00	802 300 000		7.5				120		B4	T
	G837	207 411 300 0000	80	204 411 300	A1	12.6	85	400		60	3.5	B7G	P
	G1380	023 190 0X0 0000	00	023 180 090		12				30		8SC	RR
	G1404	902 300 000 0000	00	802 300 000		4				120		B4	R
	G1503	9X2 300 000 0000	00	892 300 000		2.5				30		B4	RR
	G2004	9X2 300 000 0000	00	892 300 000		4				60		B4	RR
	G2005	9X2 300 000 0000	00	892 300 000		5				60		B4	RR
	G2080	902 310 000 0000	00	023 100 080		20				60		8SC	R
	G2080	023 100 090 0000	00	802 310 000		20				60		B5	R
	G2504	9X2 300 000 0000	00	892 300 000		4				60		B4	RR
	G3060	123 1X0 090 0000	00	123 190 080		30				60		8SC	RR
	G4004	9X2 300 000 0000	00	892 300 000		4				120		B4	R
	G4100	902 300 000 0000	00	802 300 000		4				120		B4	R
	G4120	9X2 300 000 0000	00	892 300 000		4				60		B5	RR
	G4120N	9X2 300 000 0000	00	892 300 000		4				60		B4	R
	G4180	9X2 300 000 0000	00	892 300 000		4				120		B4	RR
	G/5749	412 387 100 0000	00	412 365 100		6.3	1	250	100	11	4.4	B7G	P
	G/5750	412 388 400 0000	00	412 366 400		6.3	2	100		11	7	B7G	H
	G/6042	481 581 230 0000	00	461 471 230		25	8	250		9	2.6	AO8	TT
	G6059	041 230 871 0000	00	041 230 651		6.3	3	250	100	2	1.2	B7G	P
	G/6060	851 228 413 0000	00	741 226 413		6.3	2	250		10	5.5	B9G	TT
	G/6061	041 230 871 0000	00	*41 230 651		6.3	13	300	225	35	3.7	B9A	P
	G/6062	801 237 144 0000	00	601 235 144		6.3	7.5	250	250	45	7	B9A	P
	G6066	412 39X 800 0000	00	412 389 600		6.3	3	250	250	1	1.2	B7G	DDT
	G/6100	802 384 100 0000	00	602 364 100		6.3	8.5	250		10.5	2.2	B7G	T
	G/6132	041 230 871 0000	00	*41 230 651		6.3	4.5	250	250	40	11	B9A	P
	G/6157	001 230 000 0000	90	**1 23* ***	D1	6.3				120		B9A	R
	G/6158	854 228 413 0000	00	644 226 413		6.3	4.5	250		6	2.3	B9A	TT
	G/6180	481 581 230 0000	00	461 471 230		6.3	8	250		9	2.6	AO8	TT
	G/6516	412 380 700 0000	00	412 360 500		6.3	12.5	250	250	16	2.6	B7G	P
	GG1	299 00X X30 0000	00	288 009 930		4				30		B8B	RR
	GN24	9X2 300 000 0000	00	892 300 000		4				30		B4	RR
□	GT1C	842 310 000 0000	00	642 310 000		4	4	100		30	†3kΩ	B5	THY
□	GT1C	842 310 000 0000	00	642 310 000		4	7	200		60	†3kΩ	B5	THY
	GY11	333 022 200 0000	90	333 022 200	D1	2.5				30		F8	R
	GY501	200 320 032 0000	90	200 320 032		3.15						B9D	D
	GZ30	020 X09 030 0000	00	020 908 030		5				60		AO8	RR
	GZ31	020 X09 030 0000	00	020 908 030		5				120		AO8	RR
	GZ32	030 90X 020 0000	00	030 809 020		5(5.7)				60		AO8	RR
	GZ33	030 90X 020 0000	00	030 809 020		5				120		AO8	RR
	GZ37	030 X09 020 0000	00	030 908 020		5(5.7)				120		AO8	RR
	GZ40	290 00X 130 0000	00	28* **9 130		5				30		B8A	RR
	H2	842 300 000 0000	00	642 300 000		2	1	150		2.5	0.8	B4	T
	H2D	892 3X0 000 0000	40	682 390 000	G1	2	1.5	150		3.5	1.3	B5	DDT

SPEC.	VALVE TYPE NUMBER	PIN CONNECTIONS				CHARACTERISTICS						BASE	VALVE CLASS
		VCM163 Tester Only		CT160, VT160, VCM Mk 1,2,3,4		Vh	Vg1	Va	Vg2	la	gm mA/V		
		SELECTOR SWITCH	TOP CAP	SELECTOR SWITCH	TOP CAP	V	V	V	V	mA	†Ra MΩ		
	H4	842 300 000 0000	00	642 300 000		4	4	150		4	1.3	B4	T
	H4D	90X 231 800 0000	40	216 809 300	G1	4	3	200		4.5	2.7	B7	DDT
	H4D	218 90X 300 0000	40	809 231 600	G1	4	2.5	200		5.5	2.7	B7	DDT
	H12	842 300 000 0000	00	642 300 000		2	1.3	100		0.6	1	SM4	T
	H13	023 100 080 0000	40	023 100 060	G1	13	4	200		6	2.5	AO8	T
	H20	842 310 000 0000	00	642 310 000		20	1.6	200		0.2	1	B5	T
	H30	000 231 800 0000	40	000 231 600	G1	13	1.5	250		7.5	6	B7	T
	H42	000 231 800 0000	40	000 231 600	G1	4	2	250		1	1.5	B7	T
	H42	218 000 300 0000	40	216 000 300	G1	4	2	250		1	1.5	B7	T
	H63	020 800 310 0000	40	020 600 310	G1	6.3	2	250		1	1.6	AO8	T
	H141D	208 090 030 0000	40	206 080 030	G1	1.4	1	90		0.1	0.2	M08	DT
	H145	287 024 300 0000	00	265 024 300		1.4	2	90	90	0.3	0.42	B7G	P
	H210	842 300 000 0000	00	642 300 000		2	3	150		1.1	1.1	B4	T
	H406D	742 300 000 0000	80	542 300 000	A1	4	1.5	200	75	4	0.8	B4	P
	H407spec.	842 300 000 0000	00	642 300 000		4	9	150		3.5	0.9	B4	T
	H410	842 300 000 0000	00	642 300 000		4	3	150		0.5	0.6	B4	T
	H410D	842 300 000 0000	00	642 300 000		4	3	150		0.5	0.6	B4	T
	H412	842 300 000 0000	00	642 300 000		4	9	150		5	1.2	B4	T
	H607	842 300 000 0000	00	642 300 000		6.3	1	100			0.4	B4	T
	H1818D	742 310 000 0000	80	542 310 000	A1	20	2	200	100	3	2	B5	P
	H1918D	742 310 000 0000	80	542 310 000	A1	20	2	200	60	4	1	B5	P
	H2518D	742 310 000 0000	80	542 310 000	A1	20	2.5	250	100	3.5	2	B5	P
	H2618D	742 310 000 0000	80	542 310 000	A1	20	2.5	250	100	5	2	B5	P
	H4080D	742 310 000 0000	80	542 310 000	A1	4	1.5	200	75	4	2.5	B5	P
	H4111D	742 310 000 0000	80	542 310 000	A1	4	2.5	250	100	3.5	2	B5	P
	H4125D	742 310 000 0000	80	542 310 000	A1	4	2	200	100	6	1	B5	P
	H4129D	742 310 000 0000	80	542 310 000	A1	4	2.5	250	100	5	2	B5	P
	HAA91	192 310 X00 0000	00	182 310 900		12						B7G	DD
	HABC80	9Y1 23X 148 0000	00	811 239 146		19	3	250		1	1.2	B9A	DDDT
	HAD	X09 231 800 0000	40	908 231 600	G1	13	2.5	200		3.3	2	B7	DDT
	HBC90	412 39X 800 0000	00	412 389 600		12.5	3	250		1	1.2	B7G	DDT
	HBC91	412 39X 800 0000	00	412 389 600		12.5	2	250		1.2	1.6	B7G	DDT
	HCH81	751 238 584 0000	00	541 237 464		12.6		100		4	2	B9A	TH
	HCH81	751 238 584 0000	00	541 237 464		12.6	2.5	250	90	3	0.6	B9A	TH
	HD2	842 300 000 0000	00	642 300 000		2	5	200		5	1	B4	T
	HD2	892 3X0 000 0000	40	682 390 000	G1	2	2.5	150		3.5	1.3	B5	DDT
	HD14	038 090 200 0000	40	036 080 200	G1	1.4	0	90		0.1	0.2	AO8	DT
	HD21	892 3X0 000 0000	40	682 390 000	G1	2	1.5	150		1.8	1.5	B5	DDT
	HD22	892 3X0 000 0000	40	682 390 000	G1	2	2	150		1.8	1.5	B5	DDT
	HD23	982 3X0 000 0000	40	682 390 000	G1	2	1	150		1	1	B5	DDT
	HD23	892 3X0 000 0000	40	682 390 000	G1	2	2	150		1	1.4	B5	DDT
	HD24	892 3X0 000 0000	40	682 390 000	G1	2	1.5	150		0.8	1	B5	DDT
	HD30	724 332 800 0000	00	524 332 600		1.2	75	150	125		1.7	B7G	P
	HD93	230 232 032 0000	90	23* 232 *32	D1	1.2				1		B9A	D
	HD96	021 040 310 0000	80	021 040 310	A1	25	22.5	250	150	55	5.5	AO8	P
	HF61	280 074 130 0000	00	26* *54 130		6.3	2.6	250	100	6	2.2	B8A	P
	HF62	280 174 130 0000	00	260 154 130		6.3	2	250	250	10	9	B8A	P
	HF85	141 230 871 0000	00	141 230 651		12.5	2.3	200	125	11.4	6.1	B9A	P
	HF93	412 387 100 0000	00	412 365 100		12.5	1	250	100	11	4.4	B7G	P
	HF121	280 074 130 0000	00	26* 054 130		12.5	3	200	125	1.2	2.3	B8A	P

SPEC.	VALVE TYPE NUMBER	PIN CONNECTIONS				CHARACTERISTICS						BASE	VALVE CLASS
		VCM163 Tester Only		CT160, VT160, VCM Mk 1,2,3,4		Vh	Vg1	Va	Vg2	la	gm mA/V		
		SELECTOR SWITCH	TOP CAP	SELECTOR SWITCH	TOP CAP	V	V	V	V	mA	†Ra MΩ		
	HK90	412 388 100 0000	00	412 365 100		6.3	0	100	100	11	7	B7G	H
	HL2	842 300 000 0000	00	642 300 000		2	1.5	150		2.2	1.5	B4	T
	HL2	023 004 080 0000	00	023 004 060		2	1.5	150		2.2	1.5	8SC	T
	HL2K	842 300 000 0000	00	642 300 000		2	1.5	150		2.2	1.5	B4	T
	HL2S	023 004 080 0000	00	023 004 060		2	1.5	150		2.2	1.5	8SC	T
	HL3	208 040 030 0000	00	206 040 030		2	1.5	125		0.5	1.5	M08	T
	HL4	842 310 000 0000	00	642 310 000		4	4.5	250		5	3.5	B5	T
	HL4+	842 310 000 0000	00	642 310 000		4	4.5	250		5	4.9	B5	T
	HL4G	000 231 800 0000	40	000 231 600	G1	4	4.5	250		5	3.5	B7	T
	HL4GS	023 100 080 0000	40	023 100 060	G1	4	4.5	250		5	3.5	8SC	T
	HL13	023 100 080 0000	40	023 100 060	G1	13	13.7	200		5	3.3	8SC	T
	HL13	000 231 800 0000	40	000 231 600	G1	13	2.7	200		6	3.5	B7	T
	HL13C	000 231 800 0000	40	000 231 600	G1	13	3.7	200		5	3.3	B7	T
	HL13G	023 004 080 0000	40	023 004 060	G1	13	5.5	250		6	2.5	8SC	T
	HL13S	023 100 080 0000	40	023 100 060	G1	13	3	200		6	3.5	8SC	T
	HL21	842 300 000 0000	00	642 300 000		2	3	150		1.7	1.5	B4	T
	HL21DD	892 3X0 000 0000	40	682 390 000	G1	2	2	150		2	1.3	B5	DDT
	HL22	208 040 030 0000	00	206 040 030		2	2	150		2	1.3	M08	T
	HL22DD	208 090 X30 0000	40	206 080 930	G1	2	2	150		2	1.3	M08	DDT
	HL23	208 040 030 0000	00	206 040 030		2	1.5	150		1.5	1.2	M08	T
	HL23DD	208 090 X30 0000	40	206 080 930	G1	2	1.5	150		0.6	1.2	M08	DDT
	HL41	218 040 030 0000	00	216 040 030		4	3.1	250		2.2	3.4	M08	T
	HL41DD	218 0X0 930 0000	40	216 090 830	G1	4	3.1	250		2.2	2.6	M08	DDT
	HL42DD	218 0X0 930 0000	40	216 090 830	G1	4	0.2	200		2.8	2.9	M08	DDT
	HL84	041 230 807 0000	00	*41 23* 6*5		30	12.5	200	175	70	10	B9A	P
	HL90	412 387 400 0000	00	412 365 400		19	12.5	250	250	45	4.1	B7G	P
	HL92	142 347 800 0000	00	142 345 600		50	7.5	150	125	49	7.5	B7G	P
	HL94	142 347 800 0000	00	142 345 600		30	6.7	100	100	43	9.2	B7G	P
	HL133	218 000 030 0000	40	216 000 030	G1	13	3.3	200		6	2.9	M08	T
	HL133DD	218 0X0 930 0000	40	216 090 830	G1	13	2.5	200		1.5	2.5	M08	DDT
	HL134DD	218 090 X30 0000	40	216 080 930	G1	13	5	250		7	2.5	M08	DDT
	HL210	842 300 000 0000	00	642 300 000		2	1	100		1.1	0.7	B4	T
	HL410	842 300 000 0000	00	642 300 000		4	6	150		1.2	0.8	B4	T
	HL607	842 300 000 0000	00	642 300 000		6.3	1	100		1		B4	T
	HL1320	000 231 800 0000	40	000 231 600	G1	13	3.3	200		6	3	B7	T
	HLA1	842 310 000 0000	00	642 310 000		4	1	200		5	8	B5	T
	HLA2	842 310 000 0000	00	642 310 000		4	2.5	200		6	5.5	B5	T
	HLB1	842 300 000 0000	00	642 300 000		2	3	150		2	1.5	B5	T
	HL/DD1320	90X 231 800 0000	40	809 231 600	G1	13	3	200		4.3	1.9	B7	DDT
	HM20	842 310 000 0000	00	642 310 000		20	3.3	250		6	2.5	B5	T
	HM71	271 084 130 0000	00	251 064 130		12.6	15	200	200	0.4	†5.0	B8B	TI
	HM85	401 237 80X 0000	00	401 235 607		12.6	18	250	200	0.5	†0.47	B9A	TI
	HN309	841 238 175 0000	00	641 237 154		12	2	250		2.8	2.2	B9A	TP
	HN309	841 238 175 0000	00	641 237 154		12	9	150	150	24	5.6	B9A	TP
	HP2	548 230 800 0000	00	446 230 700		2	1	150		8.5		B7	TT
	HP6	412 381 700 0000	00	412 361 500		6.3	2	250	250	10	7.5	B7G	PP
	HP6	412 381 700 0000	00	412 361 500		6.3	1.5	200	150	4	6.4	B7G	PP
	HP13	081 231 700 0000	40	061 231 500	G1	13	1	250	100	8	3.5	B7	P
	HP13S	023 110 780 0000	40	023 110 560	G1	13	1	250	100	8	3.5	8SC	P
	HP210	742 300 000 0000	80	542 300 000	A1	2	1.5	150	150	1.9	1.9	B4	P
	HP210	041 230 700 0000	80	041 230 500	A1	2	1.5	150	150	1.9	1.9	B7	P

SPEC.	VALVE TYPE NUMBER	PIN CONNECTIONS				CHARACTERISTICS						BASE	VALVE CLASS
		VCM163 Tester Only		CT160, VT160, VCM Mk 1,2,3,4		Vh	Vg1	Va	Vg2	la	gm mA/V		
		SELECTOR SWITCH	TOP CAP	SELECTOR SWITCH	TOP CAP	V	V	V	V	mA	†Ra MΩ		
	HP210NC	742 300 000 0000	80	542 300 000	A1	2	1	150	150	1.9	1.9	B4	P
	HP210NC	041 230 700 0000	80	041 230 500	A1	2	1	150	150	1.9	1.9	B7	P
	HP211	041 230 700 0000	80	041 230 500	A1	2	1	150	150	2.6	1.7	B7	P
	HP211C	742 300 000 0000	80	542 300 000	A1	2	1	150	150	2.6	1.7	B4	P
	HP215	742 300 000 0000	80	542 300 000	A1	2	1.5	150	80	1.5	1.2	B4	P
	HP215	041 230 700 0000	80	041 230 500	A1	2	1.5	150	80	1.5	1.2	B7	P
	HP415	742 310 000 0000	80	041 231 500	A†	4	2	250	100	8	2.7	B7	P
	HP417	041 231 700 0000	80	041 231 500	A1	4	2	250	100	8	2.7	B7	P
	HP1018	180 172 300 0000	40	160 152 300	G1	10	3	250	100	2.3	1.3	B7	P
	HP1118	180 172 300 0000	40	160 152 300	G1	10	3	250	100	8.2	1.6	B7	P
	HP2018	742 310 000 0000	80	542 310 000	A1	20	2	200	100	4	3.5	B5	P
	HP2018	041 231 700 0000	80	041 231 500	A1	20	2	200	100	4	3.5	B7	P
	HP2118	742 310 000 0000	80	041 230 500	A1	20	2	200	100	5	3.5	B7	P
	HP2118	041 230 700 0000	80	542 310 000	A1	20	2	200	100	5	3.5	B5	P
	HP4100	742 310 000 0000	80	542 310 000	A1	4	2	200	100	3	3.5	B5	P
	HP4101	041 231 700 0000	80	041 231 500	A1	4	2	200	100	3.5	3.5	B7	P
	HP4101	742 310 000 0000	80	542 310 000	A1	4	2	200	100	3.5	3.5	B5	P
	HP4101C	041 231 700 0000	80	542 310 000	A1	4	2	200	100	3.5	2.8	B5	P
	HP4101C	742 310 000 0000	80	041 231 500	A1	4	2	200	100	3.5	2.8	B7	P
	HP4105	041 231 700 0000	80	542 310 000	A1	4	2	250	100	4.5	3	B5	P
	HP4105	041 231 700 0000	80	041 231 500	A1	4	2	250	100	4.5	3	B7	P
	HP4106	041 231 700 0000	80	041 231 500	A1	4	2	200	100	5	3.5	B7	P
	HP4106	742 310 000 0000	80	542 310 000	A1	4	2	200	100	5	3.5	B5	P
	HP4106C	742 310 000 0000	80	041 231 500	A1	4	2	200	100	5	3.5	B7	P
	HP4106C	041 231 700 0000	80	542 310 000	A1	4	2	200	100	5	3.5	B5	P
	HP4115	041 231 700 0000	80	041 231 500	A1	4	2	200	100	4.3	2.2	B7	P
	HP4115	742 310 000 0000	80	542 310 000	A1	4	2	200	100	4.3	3.2	B5	P
	HPT	412 381 700 0000	00	412 361 500		6.3	2	250	250	10	7.5	B7G	P
	HPT	412 381 700 0000	00	412 361 500		6.3	1.5	200	150	4	6.4	B7G	P
	HR1	200 300 000 0000	90	2** 3** *00	D1	0.6				0.05		B7G	D
	HR2	842 300 000 0000	00	642 300 000		2	2	150		12	0.6	B4	T
	HR2	112 311 100 0000	90	112 311 100	D1	4				5		B7G	R
	HR2S	023 004 080 0000	00	023 004 060		2	2	150		1.2	0.6	8SC	T
	HR3	112 311 100 0000	90	112 311 100	D1	4				15		B7G	R
	HR4	112 311 100 0000	90	112 311 100	D1	4				30		B7G	R
	HR6	030 000 020 0000	90	030 000 020	D1	4				60		AO8	R
	HR7	020 000 030 0000	90	020 000 030	D1	4				30		AO8	R
	HR8	030 000 020 0000	90	030 000 020	D1	4				30		AO8	R
	HR11	020 000 030 0000	90	020 000 030	D1	4						AO8	D
	HR210	842 300 000 0000	00	642 300 000		2	1.5	200		1	1.3	B4	T
	HR406	842 300 000 0000	00	642 300 000		4	3	200		1	1.5	B4	T
	HR410	841 300 000 0000	00	641 300 000		4	3	200		1	1.5	B4	T
	HSD	90X 231 800 0000	40	809 231 600	G1	13	3	200		6	2.7	B7	DDT
	HVR1	002 300 000 0000	90	002 300 000	D1	2				5		B4	R
	HVR2	003 200 000 0000	90	003 200 000	D1	4				3		B4	R
	HVR2A	003 200 000 0000	90	003 200 000	D1	2(2.5)				3		B4	R
	HVU1	002 300 000 0000	90	002 300 000	D1	4				3		B4	R
	HY24	284 300 000 0000	00	264 300 000		2	45	200		20		UX4	T
	HY61	274 130 000 0000	80	254 130 000	A1	6.3	14	300	250	83	6.5	UX5	P
	HY65	030 740 210 0000	80	030 540 210	A1	6.3	45	350	200	63		AO8	P

SPEC.	VALVE TYPE NUMBER	PIN CONNECTIONS				CHARACTERISTICS						BASE	VALVE CLASS
		VCM163 Tester Only		CT160, VT160, VCM Mk 1,2,3,4		Vh	Vg1	Va	Vg2	la	gm mA/V		
		SELECTOR SWITCH	TOP CAP	SELECTOR SWITCH	TOP CAP	V	V	V	V	mA	†Ra MΩ		
	HY90	002 396 100 0000	00	002 386 100		27.5				60		B7G	R
	HY113	284 030 000 0000	00	264 030 000		1.4	4.5	60		0.4	0.2	UX5	T
	HY125	384 720 000 0000	00	364 520 000		1.4	3	60	50	0.9	0.3	UX5	P
	HY615	020 000 310 0000	84	020 000 310	A1/G1	6.3	35	300		20		AO8	T
	HY866	290 300 000 0000	00	280 300 000		2.5				120		UX4	R
	HZ50	290 300 000 0000	00	280 300 000		13				60		UX4	R
	IF860	141 230 871 0000	00	141 230 651		20		200	200	8.5	6.6	B9A	P
	IL861	041 230 871 0000	00	041 230 651		20		200	200	20	11	B9A	P
	IRV120/350S	023 190 0X0 0000	00	023 180 090		4				60		8SC	RR
	IW2	9X3 200 000 0000	00	893 200 000		4				30		B4	RR
	IW2A	9X2 300 000 0000	00	892 300 000		4				30		B4	RR
	IW3	9X2 300 000 0000	00	892 300 000		4				60		B4	RR
	IW4/500	9X3 200 000 0000	00	893 200 000		4				60		B4	RR
	K2/DD	892 3X0 000 0000	40	682 300 000		2	3.8	150		4	1.6	B5	DDT
	K4	9X2 300 000 0000	00	892 300 000		4				120		B4	RR
	K23A	892 3X0 000 0000	40	682 390 000	G1	2	5.5	150		2.5	1.4	B5	DDT
	K23B	892 3X0 000 0000	40	682 390 000	G1	2	1.5	150		1.4	1.2	B5	DDT
	K24	287 130 000 0000	40	265 130 000	G1	2.5	1.5	200	75	2	0.8	UX5	P
	K27	284 130 000 0000	00	264 130 000		2.5	4.5	90		3	1	UX5	T
	K30A	842 300 000 0000	00	642 300 000		2	3	150		1.5	0.8	B4	T
	K30B	842 300 000 0000	00	642 300 000		2	7.5	150		4	0.9	B4	T
	K30C	842 300 000 0000	00	642 300 000		2	1.5	150		2	1.4	B4	T
	K30D	842 300 000 0000	00	642 300 000		2	3	150		4	1.5	B4	T
	K30E	842 300 000 0000	00	642 300 000		2	4.5	150		2	1.5	B4	T
	K30G	842 300 000 0000	00	642 300 000		2	7	150		6	3.5	B4	T
	K33A	084 235 800 0000	00	064 234 700		2	0	150		3		B7	TT
	K33B	548 230 800 0000	00	446 230 700		2	1.5	125		3	2.1	B7	TT
	K40B	742 300 000 0000	80	542 300 000	A1	2		150	75	2	1.5	B4	P
	K40N	041 230 700 0000	80	542 300 000	A1	2		150	90	2.5	1.4	B4	P
	K40N	742 300 000 0000	80	041 230 500	A1	2		150	90	2.5	1.4	B7	P
	K50M	041 231 700 0000	80	041 231 500	A1	2	5	150	125	3	1.5	B7	P
	K50N	084 237 700 0000	40	064 235 500	G1	2	1.5	150	60	2	1.4	B7	P
	K70B	842 370 000 0000	00	642 350 000		2	4.5	150	150	9.5	2.5	B5	P
	K70D	842 370 000 0000	00	642 350 000		2	2.4	150	150	5	4	B5	P
	K77A	487 230 785 0000	00	465 230 574		2	10.5	150	150	2.5	4	B9	PP
	K77B	548 237 800 0000	00	446 235 700		2	11.7	150	150	3.8		B7	PP
	K80A	845 230 X00 0000	00	645 230 700	G1	2		150	50	2		B7	O
	K80A	845 230 X00 0000	00	645 230 700	G1	2		150	75	1		B7	O
	K80B	845 230 X00 0000	00	645 230 700	G1	2		150	150	2.1		B7	O
	K80B	845 230 X00 0000	00	645 230 700	G1	2		150	150	0.7		B7	O
	K435/10	842 300 000 0000	00	642 300 000		4	3	300		50	5	B4	T
	K450/50	842 300 000 0000	00	642 300 000		4	50	400		120	5	B4	T
	K1658	742 310 000 0000	80	542 310 000	A1	7	25	400	225	50	3.2	B5	P
	K1694	842 300 000 0000	00	642 300 000		4	3.5	200		6	2.6	B4	T
	KBC1	-	-	023 098 060	G1	2	4.5	150		2.5	1	8SC	DDT
	KBC32	038 X90 200 0000	40	036 980 200	G1	2		100		2.4	1.2	AO8	DDT
	KC1	023 004 080 0000	00	023 004 060		2	1.5	150		1.2	0.6	8SC	T
	KC3	023 004 080 0000	00	023 004 060		2	2.8	150		3	2.5	8SC	T
	KC4	023 004 080 0000	00	023 004 060		2	1.5	150		2.2	1.4	8SC	T
	KC50	842 300 000 0000	00	642 300 000		2	1	40		0.2	0.4	SM4	T

SPEC.	VALVE TYPE NUMBER	PIN CONNECTIONS				CHARACTERISTICS						BASE	VALVE CLASS
		VCM163 Tester Only		CT160, VT160, VCM Mk 1,2,3,4		Vh	Vg1	Va	Vg2	la	gm mA/V		
		SELECTOR SWITCH	TOP CAP	SELECTOR SWITCH	TOP CAP	V	V	V	V	mA	†Ra MΩ		
	KC51	842 300 000 0000	00	642 300 000		2	2	40		1.2	0.5	SM4	T
	KCF30	038 748 200 0000	50	037 546 200	G1	2	1.0	100		3.7	1.6	AO8	TP
	KCF30	038 750 200 0000	50	037 546 200	G1	2	2.5	150	80	1.5	0.9	AO8	TP
	KCH1	023 084 780 0000	50	023 064 570	G1	2	0.5	90		3	1.5	8SC	TH
	KCH1	023 005 780 0000	50	023 064 570	G1	2	5	90	60	1	0.9	8SC	TH
	KD50	842 300 000 0000	00	642 300 000		2	2.8	40		1.8	0.6	SM4	T
	KDD1	023 084 580 0000	00	023 074 460		2		90		0.8	0.8	8SC	TT
	KE50	742 300 000 0000	80	542 300 000	A1	2	2	150	50	0.8	0.6	Sm4	P
	KF1	070 412 300 0000	80	050 412 300	A1	2	1	150	150	3	1.8	C7	P
	KF2	070 412 300 0000	80	050 412 300	A1	2	1	150	150	3	1.3	C7	P
	KF3	023 010 780 0000	40	023 010 560	G1	2	1	90	90	1	0.5	8SC	P
	KF4	023 010 780 0000	40	023 010 560	G1	2	1	90	90	1.2	0.7	8SC	P
	KF7	023 004 700 0000	80	023 004 500	A1	2	1.5	90	90	1.8	0.7	8SC	P
	KF8	023 004 700 0000	80	023 004 500	A1	2	1	90	90	1.5	0.6	8SC	P
	KF35	028 710 300 0000	40	026 510 300	G1	2	1.5	150	60	1.4	1.1	AO8	P
	KH1	023 071 780 0000	40	023 051 560	G1	2	1.5	90	60	2.1	1.4	8SC	P
	KK2	023 084 780 0000	40	023 064 560	G1	2	1	90	50	2		8SC	O
	KK2G	028 748 300 0000	40	026 546 300	G1	2	1	90	50	2		AO8	O
	KK32	03X 748 200 0000	00	037 546 200	G1	2		150	50	2.1		AO8	O
	KK32	03X 748 200 0000	00	037 546 200	G1	2		150	50	0.7		AO8	O
	KL1	842 370 000 0000	00	642 350 000		2	4.5	90	90	8	1.7	B5	P
	KL1	032 004 780 0000	00	032 004 560		2	4.5	90	90	8	1.7	8SC	P
	KL2	023 004 780 0000	00	023 004 560		2	7.5	90	90	11	1.8	8SC	P
	KL4	023 004 780 0000	00	023 004 560		2	2.5	100	100	5	2	8SC	P
	KL4G	038 740 200 0000	00	036 540 200		2	2.5	90	90	4.7	1.8	AO8	P
	KL5	032 004 780 0000	00	032 004 560		2	4	90	90	4.8	1.4	8SC	P
	KL35	038 740 200 0000	00	036 540 200		2	4.5	150	150	5.6	2.2	AO8	P
	KLL3	523 784 780 0000	00	423 564 570		2	12	150	150	8		8SC	PP
	KLL32	028 548 370 0000	00	026 447 350		2	11.3	150	150	3.8	2.6	AO8	PP
	KM84	401 237 808 0000	00	4*1 235 6*6		4.2	22	250	250	0.5	†0.5	B9A	TI
	KR5	284 730 000 0000	00	264 530 000		6.3	9	150	150	14	1.9	UX5	P
	KR20	284 413 000 0000	00	264 413 000		2.5		250		3.5	1.4	UX6	T
	KR22	284 413 000 0000	00	264 413 000		6.3		250		3.5	1.4	UX6	T
	KR25	284 413 000 0000	00	264 413 000		2.5	16.5	250	250	34	2.2	UX6	P
	KR28	29X 130 000 0000	00	289 130 000		6.3				30		UX5	RR
	KR31	291 300 000 0000	00	281 300 000		10				120		UX4	R
	KT2	842 370 000 0000	00	642 350 000		2	4.5	150	150	7.5	2.5	B5	P
	KT8	742 310 000 0000	80	542 310 000	A1	6.3	16	250	250	72	6	B5	P
	KT16	028 740 230 0000	00	026 540 230		1.4	4.5	90	90	8.8	1.9	AO8	P
	KTKT21	842 370 000 0000	00	642 350 000		2	2.5	150	125	5.3	5.3	B5	P
	KT24	842 370 000 0000	00	642 350 000		2	3.5	150	125	5	3.2	B5	P
	KT30	047 231 800 0000	00	045 231 600		13	12	250	250	40	3.9	B7	P
	KT31	307 221 800 0000	40	305 221 600	G1	13	4	200	175	40	10	B7	P
	KT32	028 740 310 0000	00	026 540 310		26	7.6	150	150	75	9	AO8	P
	KT33	328 740 210 0000	00	326 540 210		13	13.2	200	200	60	10	AO8	P
	KT33C	328 740 210 0000	00	326 540 210		13	7	200	175	92	10	AO8	P
	KT35	328 740 210 0000	00	326 540 210		13	11.5	200	200	50	10	AO8	P
	KT36	020 740 310 0000	80	020 540 310	A1	26	10	150	150	60	11	AO8	P
	KT41	047 231 800 0000	00	045 231 600		4(5)	4.4	250	250	40	10.5	B7	P
	KT42	047 231 800 0000	00	045 231 600		4	16.5	250	250	34	2.5	B7	P
	KT44	041 231 700 0000	80	041 231 500	A1	4(5)	25	250	250	85	6.3	B7	P

SPEC.	VALVE TYPE NUMBER	PIN CONNECTIONS				CHARACTERISTICS						BASE	VALVE CLASS
		VCM163 Tester Only		CT160, VT160, VCM Mk 1,2,3,4		Vh	Vg1	Va	Vg2	la	gm mA/V		
		SELECTOR SWITCH	TOP CAP	SELECTOR SWITCH	TOP CAP	V	V	V	V	mA	†Ra MΩ		
	KT61	028 740 310 0000	00	026 540 310		6.3	4.4	250	250	40	10.5	AO8	P
	KT63	028 740 310 0000	00	026 540 310		6.3	16.5	250	250	34	2.5	AO8	P
	KT66	028 740 310 0000	00	026 540 310		6.3	15	250	250	65	6.3	AO8	P
	KT67	278 001 403 0000	00	256 001 403		6.3	9	250	175	80	13	B9G	P
	KT71	028 740 310 0000	00	026 540 310		48	9.8	200	175	70	10	AO8	P
	KT72	028 740 310 0000	00	026 540 310		16	12.5	200	175	30	2.5	AO8	P
	KT73	028 740 310 0000	00	026 540 310		63	4.5	200	175	35	2.5	AO8	P
	KT74	028 740 310 0000	00	026 540 310		16	12.5	200	175	30	2.5	AO8	P
	KT76	028 740 310 0000	00	026 540 310		15	13	200	175	35	2.5	AO8	P
	KT77	028 740 310 0000	00	026 540 310		6.3		250	250	100	11.5	AO8	P
	KT81	287 004 130 0000	00	265 004 130		6.3	4.4	250	250	40	10.5	B8B	P
	KT88	028 740 310 0000	00	026 540 310		6.3	20	250	250	57	8	AO8	P
	KT101	287 004 130 0000	00	265 004 130		80	9.5	200	175	70	10	B8B	P
	KTW61	028 710 310 0000	40	026 510 310	G1	6.3	4	250	100	10	2.9	AO8	P
	KTW62	028 700 310 0000	40	026 500 310	G1	6.3	3	250	100	8	2.8	AO8	P
	KTW63	028 710 310 0000	40	026 510 310	G1	6.3	3	250	100	7.6	1.5	AO8	P
	KTW73	028 710 310 0000	40	026 510 310	G1	6.3	3	250	100	6.5	1.7	AO8	P
	KTW73M	028 700 310 0000	40	026 500 310	G1	6.3	3	250	100	6.5	1.7	AO8	P
	KTW74	028 710 310 0000	40	026 510 310	G1	13	3	250	100	7.6	1.5	AO8	P
	KTW74M	028 700 310 0000	40	026 500 310	G1	13	3	250	100	7.6	1.5	AO8	P
	KTZ41	081 231 700 0000	40	061 231 500	G1	4	1.5	250	250	18	12	B7	P
	KTZ63	028 710 310 0000	40	026 510 310	G1	6.3	3	250	100	2	1.2	AO8	P
	KTZ73	028 700 310 0000	40	026 500 310	G1	6.3	3	250	100	2	1.5	AO8	P
	KTZ73M	028 700 310 0000	40	026 500 310	G1	6.3	3	250	100	2	1.5	AO8	P
	KZ	902 310 000 0000	00	802 310 000		20				60		B5	R
	L2	842 300 000 0000	00	642 300 000		2	4.5	150		9	1.6	B4	T
	L2/B	842 300 000 0000	00	642 300 000		2	3.8	150		4	1.5	B4	T
	L2D	842 310 000 0000	00	642 310 000		2	4.5	150		2	1.5	B5	T
	L2/DD	892 3X0 000 0000	00	682 390 000	G1	2	3.8	150		4	1.6	B5	DDT
	L4	842 300 000 0000	00	642 300 000		4	16	250		20	3.2	B4	T
	L5A/201K	412 381 700 0000	00	412 361 500		6.3	3.3	200	200	7.1	4	B7G	P
	L5A/202F	412 381 700 0000	00	412 361 500		6.3	3.3	200	200	7.1	4	B7G/F	P
	L5A/210K	412 381 700 0000	00	412 361 500		6.3	5	100	100	12.5	4	B7G	P
	L5A/210F	412 381 700 0000	00	-		6.3	5	100	100	12.5	4	B7G/F	P
	L5A/220K	801 227 413 0000	00	601 225 413		5	10	150	150	28	4.4	B9A	P
	L5B/28CD	028 741 310 0000	00	**6 541 310		6.3	8.5	150	150	200	13.5	AO8	P
	L11	842 300 000 0000	00	642 300 000		1	12	100		2.8	0.6	B4	T
	L12	842 300 000 0000	00	642 300 000		2	3	40		2.2	0.8	Sm4	T
	L21	842 300 000 0000	00	642 300 000		2	6	150		3.2	1.8	B4	T
	L21DD	892 3X0 000 0000	40	682 390 000	G1	2	3	150		5.2	1.8	B5	DDT
	L22DD	208 090 X30 0000	40	206 080 930	G1	2	4.2	150		4	1.6	AO8	DDT
	L30	042 231 800 0000	00	042 231 600		13	8	200		25	4.2	B7	T
	L42MD	842 370 000 0000	00	642 350 000		4	20	250	250	22	2.5	B5	P
	L63	028 040 310 0000	00	026 040 310		6.3	8	250		9	2.6	AO8	T
	L77	802 384 100 0000	00	6*2 364 100		6.3	8.5	250		10.5	2.2	B7G	T
	L210	842 300 000 0000	00	642 300 000		2		150			0.9	B4	T
	L408	842 300 000 0000	00	642 300 000		4	3	150		5	1.5	B4	T
	L410	842 300 000 0000	00	642 300 000		4	4	150		4.3	1.5	B4	T
	L412	842 300 000 0000	00	642 300 000		4	1.5	200		3	1.2	B4	T
	L413	842 300 000 0000	00	642 300 000		4	16	200		12	1.8	B4	T
	L414	842 300 000 0000	00	642 300 000		4	8	150		12	2.8	B4	T
	L415	842 300 000 0000	00	642 300 000		4	10	200		8	2	B4	T
	L416D	843 200 000 0000	70	643 200 000	G2	4	13	250	80	12	1.4	B4	P
	L427D	842 370 000 0000	00	642 350 000		4	42	300	200	20	1.5	B5	P
	L486D	842 370 000 0000	00	642 350 000		4	15	250	250	35	2.7	B5	P



SPEC.	VALVE TYPE NUMBER	PIN CONNECTIONS				CHARACTERISTICS						BASE	VALVE CLASS
		VCM163 Tester Only		CT160, VT160, VCM Mk 1,2,3,4		Vh	Vg1	Va	Vg2	Ia	gm mA/V		
		SELECTOR SWITCH	TOP CAP	SELECTOR SWITCH	TOP CAP	V	V	V	V	mA	†Ra MΩ		
L491	842 370 000 0000	00	642 350 000		4	40	400	200	30	1.8	B5	P	
L491D	842 370 000 0000	00	642 350 000		4	40	400	200	30	1.8	B5	P	
L495	942 370 000 0000	00	842 350 000		4	30				5	B5	D	
L497D	842 370 000 0000	00	642 350 000		4	30	400	200	45	3.2	B5	P	
L510D	842 370 000 0000	00	642 350 000		5	17	200	150	12	1.3	B5	P	
L2318	842 370 000 0000	00	642 350 000		20	18	200	200	20	1.7	B5	P	
L4150D	842 310 000 0000	40	642 310 000	G1	4	15	250	250	24	2.5	B5	P	
LA	384 720 000 0000	00	364 520 000		6.3	12	200	175	22	2.2	UX5	P	
LD210	842 300 000 0000	00	642 300 000		2	4.5	150		3	1.3	B4	T	
LD410	842 300 000 0000	00	642 300 000		4	6	200		4	1.8	B4	T	
LG5	219 0X0 130 0000	00	218 090 130		6.3				120		AO8	RR	
LG6	219 0X0 130 0000	00	218 090 130		12				30		B8B	RR	
LG14	123 000 000 0000	90	123 000 000	D1	6.3				5		B3G	R	
LK430	842 300 000 0000	00	642 300 000		4	32	250		20	1.9	B4	T	
LK460	842 300 000 0000	00	642 300 000		4	40	250		30	2.2	B4	T	
LK4110	842 300 000 0000	00	642 300 000		4	36	400		30	2.7	B4	T	
LK4112	842 300 000 0000	00	642 300 000		4	21.6	250		48	3.5	B4	T	
LK4200	842 300 000 0000	00	642 300 000		4	36	400		45	4	B4	T	
LL2	842 300 000 0000	00	642 300 000		2	2.5	150		3	2.5	B4	T	
LL2S	023 004 080 0000	00	023 004 060		2	2.5	150		3	2.6	8SC	T	
LL4	842 310 000 0000	00	642 310 000		4	10	350		18	3.5	B5	T	
LL610	842 370 000 0000	00	642 350 000		5	17	200	150	12	1.3	B5	P	
LN119	415 238 175 0000	00	414 237 516		50	0	100		3.5	2.5	B9A	TP	
LN119	415 238 175 0000	00	414 237 516		50	16	200	200	35	6.4	B9A	TP	
LN152	841 238 175 0000	00	641 237 154		6.3	2.3	100		4.0	1.4	B9A	TP	
LN152	841 238 175 0000	00	641 237 154		6.3	6.7	200	175	15.0	3.2	B9A	TP	
LN309	841 238 175 0000	00	641 237 154		12.5	8.5	250		10.5	2.2	B9A	TP	
LN309	841 238 175 0000	00	641 237 154		12.5	8.0	200	175	30	4.5	B9A	TP	
LN319	841 238 175 0000	00	641 237 154		13		200		10	3.4	B9A	TP	
LN319	841 238 175 0000	00	641 237 154		13	9	200	175	32	6.5	B9A	TP	
LN329	857 238 114 0000	00	645 237 114		9	2	100		14	5	B9A	TP	
LN329	857 238 114 0000	00	645 237 114		9	2	200	175	10	6.2	B9A	TP	
LP2	842 300 000 0000	00	642 300 000		2	4.5	150		10	3.6	B4	T	
LP4	842 300 000 0000	00	642 300 000		4	36	250		48	5.5	B4	T	
LP25	842 300 000 0000	00	642 300 000		4	31	400		50	7.5	B4	T	
LP220	842 300 000 0000	00	642 300 000		2	4.5	150		5	3.5	B4	P	
LS5	842 300 000 0000	00	642 300 000		4.7	47	400		25		B4	T	
LS5A	842 300 000 0000	00	642 300 000		5.2		400		33	0.9	B4	T	
LS6A	842 300 000 0000	00	642 300 000		6.3	91	400		64	2.3	B5	T	
LS7	842 300 000 0000	00	642 300 000		4	4	150		21	2.4	B5	T	
LS8	842 300 000 0000	00	642 300 000		4	8	150			1.3	B4	T	
LS8A	842 300 000 0000	00	742 300 000		4	8	150		26	3	B4	T	
LS9B	842 300 000 0000	00	642 300 000		2	1.5	150		8	0.6	B4	T	
LS826	284 310 000 0000	00	246 310 000		6.3	1.1	100		7.5	5	B8B	T	
LU4A	842 300 000 0000	00	642 300 000		4	16	200		12	1.8	B4	T	
LZ319	857 238 114 0000	00	645 237 114		9	2	100		14	5	B9A	TP	
LZ319	857 238 114 0000	00	645 237 114		9	2	200	175	10	6.2	B9A	TP	
L496D	842 370 000 0000	00	642 350 000								B5	D	
LZ329	857 238 114 0000	00	645 237 114		9	2.0	100		14	5	B9A	TP	
LZ329	857 238 114 0000	00	645 237 114		9	2.0	200	175	10	6	B9A	TP	
M0465	847 231 900 0000	00	645 231 700	G1	4		75		2		B7	O	
M0465	847 231 900 0000	00	645 231 700	G1	4	1.5	250	75	21.6		B7	O	

SPEC.	VALVE TYPE NUMBER	PIN CONNECTIONS				CHARACTERISTICS						BASE	VALVE CLASS	
		VCM163 Tester Only		CT160, VT160, VCM Mk 1,2,3,4		Vh	Vg1	Va	Vg2	Ia	gm mA/V			
		SELECTOR SWITCH	TOP CAP	SELECTOR SWITCH	TOP CAP	V	V	V	V	mA	†Ra MΩ			
	M0495	123 184 760 0000	40	123 174 560	G1	4	1.5	90					8SC	O
	M0495	123 184 760 0000	40	123 174 560	G1	4	8.5	250	75	1.6			8SC	O
	M3057	041 230 871 0000	00	041 230 651		6.3	4.5	200	200	30	9		B9A	P
	M8079	1X2 310 900 0000	00	192 310 800		6.3				5			B7G	RR
	M8080	802 384 100 0000	00	602 365 100		6.3	8.5	250		10.5	2.2		B7G	T
	M8081	882 345 100 0000	00	672 344 100		6.3	0.8	100		8.5	5.3		B7G	TT
	M8082	412 380 700 0000	00	412 360 500		6.3	12.4	250	250	16	2.6		B7G	P
	M8083	412 381 700 0000	00	412 361 500		6.3	2	250	250	10	7.65		B7G	P
	M8083	412 381 700 0000	00	412 361 500		6.3	1.5	200	150	4	6.4		B7G	P
	M8091	001 230 000 0000	90	**1 23* **	D1	6.3				120			B9A	R
	M8096	801 237 144 0000	00	601 235 144		6.3	7.5	250	250	45	7		B7A	P
	M8097	912 314 800 0000	00	812 314 600		6.3	2.8	200		7.5	2.8		B7G	DT
	M8099	412 314 800 0000	00	412 314 600		6.3	2	250		6	8.5		B7G	T
	M8100	412 387 100 0000	00	412 365 100		6.3	2.3	150	150	7	4.3		B7G	P
	M8101	412 387 100 0000	00	412 365 100		6.3	1	250	100	11	4.4		B7G	P
	M8121	412 183 710 0000	00	412 163 510		6.3	1.4	100	100	7	5		B8D	P
	M8122	412 873 180 0000	00	412 653 160		6.3	2	100	100	7.5	5		B8D	P
	M8123	291 390 000 0000	00	281 380 000		6.3				5			B8D	R
	M8125	412 183 710 0000	00	412 163 510		6.3	2	100	100	3	2.5		B8D	P
	M8135	412 300 871 0000	00	412 3** 651		6.3	4.5	250	250	40	11		B9A	P
	M8136	851 228 413 0000	00	741 226 413		6.3	8.5	250		8.5	2.2		B9A	TT
	M8137	851 228 413 0000	00	741 226 413		6.3	2	250		1.2	1.6		B9A	TT
	M8138	902 30X 100 0000	00	802 309 100		6.3				30			B7G	RR
	M8156	482 803 180 0000	00	462 603 160		6.3	2	100		13	5.5		B8D	T
	M8157	287 711 413 0000	00	265 511 413		6.3	30	300	250	25	1.9		B9G	P
	MS161	412 381 700 0000	00	412 361 500		6.3	2.5	250	200	8	2.5		B7G	P
	M8162	851 228 413 0000	00	741 226 413		6.3	1.5	200		8.5	6.5		B9A	TT
	M8178	402 013 080 0000	00	402 013 060		6.3		100		8.5	5.8		B8D	T
	M8180	412 380 700 0000	00	412 360 500		6.3	2	250	250	10	7.5		B7G	P
	M8195	701 238 014 0000	00	501 236 014		6.3	1	250	100	3	1.8		B9A	P
	M8196	412 287 100 0000	00	412 265 100		6.3	2	150	125	5.5	3.5		B7G	P
	M8212	192 310 X00 0000	00	182 310 900		6.3				5			B7G	RR
	M8245	412 387 400 0000	00	412 365 400		6.3	12.5	250	250	45	4.1		B7G	P
	M8248	412 344 800 0000	00	412 344 600		6.3	1.35	150		13.5	13.5		B7G	T
	MAZ41	090 00X 230 0000	00	*8* **9 23*		4				30			AO8	RR
	MC1	423 080 000 0000	00	423 060 000		1.9	1.5	100		4	0.8		8SC	T
	ME2	842 370 000 0000	00	642 350 000		2	12	200	200	13			B5	P
	ME25	842 370 000 0000	00	642 350 000		4	30	400	300	60			B5	P
	ME4S	023 104 780 0000	00	023 104 560		4	5	250	250		†2.0		8SC	TI
	ME6S	023 104 780 0000	00	023 104 560		6.3	5	250	250		†2.0		8SC	TI
	ME25	842 370 000 0000	00	642 350 000		4	30	400	300	60			B5	P
	ME41	218 040 730 0000	00	216 040 530		4	22.5	250	250	0.2	†1.0		M08	TI
	ME91	218 040 730 0000	00	216 040 530		9	17	150	150	0.2	†1.0		M08	TI
	ME920	047 231 800 0000	00	045 231 600		9	19	200	175	0.2	†1.0		B7	TI
	ME1400	028 710 310 0000	40	026 510 310	G1	6.3	2	250	100	1	1.8		AO8	P
	MH4	842 310 000 0000	00	642 310 000		4	2	200		8	3		B5	T
	MH40	842 310 000 0000	00	642 310 000		4	3	200		2.7	2.4		B5	T
	MH41	842 310 000 0000	00	642 310 000		4	1.5	200		5.2	6		B5	T
	MH206	847 230 800 0000	40	645 230 600	G1	2	3	150	75	3.2			B7	H
	MH1118	847 231 800 0000	40	645 231 600	G1	10	3	200	100	3.5			B7	H
	MH4105	847 231 800 0000	40	645 231 600	G1	4	3	200	100	7.5			B7	H
	MHD4	X09 231 800 0000	40	908 231 600	G1	4	4	200		2	1.9		B7	DDT

SPEC.	VALVE TYPE NUMBER	PIN CONNECTIONS				CHARACTERISTICS						BASE	VALVE CLASS
		VCM163 Tester Only		CT160, VT160, VCM Mk 1,2,3,4		Vh	Vg1	Va	Vg2	la	gm mA/V		
		SELECTOR SWITCH	TOP CAP	SELECTOR SWITCH	TOP CAP	V	V	V	V	mA	†Ra MΩ		
	MHL4	842 310 000 0000	00	642 320 000		4	8	250		8	2.5	B5	T
	MHLD6	028 9X0 310 0000	40	026 890 310	G1	6.3	5	200		11.5	3	AO8	DDT
	MKT4	047 231 800 0000	00	045 231 600		4	11	250	200	32	3	B7	P
	MKT4	842 310 000 0000	70	642 310 000	G2	4	11	250	200	32	3	B5	P
	ML4	842 310 000 0000	00	642 310 000		4	16	250		14	3.2	B5	T
	ML6	842 310 000 0000	00	642 310 000		6.3	8	200		24	3.8	B5	T
	ML40	842 310 000 0000	00	642 310 000		4	3	200			3	B5	T
	MM4V	742 310 000 0000	80	542 310 000	A1	4	1.5	200	125	6	2.5	B5	P
	MM20	742 310 000 0000	80	542 310 000	A1	20		200	100	6	3.5	B5	P
	MP2	842 300 000 0000	00	642 300 000		2	12	150		12.5	3	B4	T
	MP4	080 231 700 0000	40	067 231 500	G1	4		250	150	8	2.5	B7	PP
	MP4	008 231 700 0000	50	067 231 500	G1	4		250	150	8	2.5	B7	PP
	MP/Pen	047 231 800 0000	00	045 231 600		4	16	250	250	3	3.5	B7	P
	MP/Pen	842 310 000 0000	70	642 310 000	G2	4	16	250	250	30	3.5	B5	P
	MPT4	047 231 800 0000	00	045 231 600		4	9	250	200	32	3	B7	P
	MPT4	842 310 000 0000	40	642 310 000	G1	4	9	250	200	32	3	B5	P
	MR1	902 300 000 0000	00	802 300 000		4				120		B4	R
	MR4	842 300 000 0000	00	642 300 000		4	3	200		6	2.5	B4	T
	MS4	742 310 000 0000	80	542 310 000	A1	4	1.5	250	75	2.4	1.1	B5	P
	MS4B	742 310 000 0000	80	542 310 000	A1	4	1	200	75	3.4	3	B5	P
	MS4C	742 310 000 0000	80	542 310 000	A1	4	1	200	75	3.4	3.2	B5	P
	MSG/HA	742 310 000 0000	80	542 310 000	A1	4	1.5	200	80	2.1	2	B5	P
	MSG/LA	742 310 000 0000	80	542 310 000	A1	4	1.5	200	75	5.2	3.7	B5	P
	MSP4	742 310 000 0000	80	041 231 500	A1	4	1.8	200	100	3.4	2.4	B7	P
	MSP4	041 231 700 0000	80	542 310 000	A1	4	1.8	200	100	3.4	2.4	B5	P
	MSP41	742 310 000 0000	80	542 310 000	A1	4	4	250	250	8.5	3.2	B5	P
	MSP41	041 231 700 0000	80	041 231 500	A1	4	4	250	250	8.5	3.2	B7	P
	MS/Pen	041 231 700 0000	80	041 231 500	A1	4	1.5	200	100	4.8	2.8	B7	P
	MS/Pen	742 310 000 0000	80	542 310 000	A1	4	1.5	200	100	4.8	2.8	B5	P
	MS/PenA	742 310 000 0000	80	542 310 000	A1	4	2.5	200	150	9	4	B5	P
	MS/PenA	041 231 700 0000	80	041 231 500	A1	4	2.5	200	150	9	4	B7	P
	MS/PenB	081 231 700 0000	40	061 231 500	G1	4	1.5	200	100	4.8	2.8	B7	P
	MSVPen	041 231 700 0000	80	041 231 500	A1	4	1.5	200	100	4.3	2.2	B7	P
	MSVPenB	081 231 700 0000	40	061 231 500	G1	4	1.5	200	100	4.3	2.2	B7	P
	MU1	002 300 000 0000	90	002 300 000	D1	4				60		B4	R
	MU2	002 300 000 0000	90	002 300 000	D1	2				2		B4	R
	MU12	9X2 300 000 0000	00	892 300 000		4				60		B4	RR
	MU4250	232 300 000 0000	90	232 300 000	D1	4				120		B4	R
	MVSG	742 310 000 0000	80	542 310 000	A1	4	1.5	200	75	7.5	2.5	B5	P
	MVSPen	742 310 000 0000	80	542 310 000	A1	4	2	250	125	5.1	2.3	B5	P
	MX40	847 231 900 0000	00	645 231 700	G1	4	1	150	75		0.15	B7	TH
	MX40	847 231 900 0000	00	645 231 700	G1	4	3	250	75	4.5	2.0	B7	TH
	MZ05-20	842 300 000 0000	00	642 300 000		6.3	12	350		45	4.2	B4	T
	N14	038 740 200 0000	00	036 540 200		1.4	7.5	90	90	7	1.5	AO8	P
	N15	028 740 230 0000	00	026 540 230		1.4	7	90	90	7	1.5	AO8	P
	N16	028 740 230 0000	00	026 540 230		1.4	4.5	90	90	9.5	2.1	AO8	P
	N17	284 738 200 0000	00	264 536 200		1.4	7	90	75	7.4	1.5	B7G	P
	N18	384 728 300 0000	00	364 526 300		1.4	4.5	90	90	9.5	2.1	B7G	P
	N19	387 024 300 0000	00	365 024 300		1.4	4.5	90	90	7.7	2	B7G	P
	N25	387 024 300 0000	00	365 *24 300		1.4	5.2	90	90	5	1.4	B7G	P
	N30	047 231 800 0000	00	045 231 600		13	12	250	250	40	0.9	B7	P

SPEC.	VALVE TYPE NUMBER	PIN CONNECTIONS				CHARACTERISTICS						BASE	VALVE CLASS
		VCM163 Tester Only		CT160, VT160, VCM Mk 1,2,3,4		Vh	Vg1	Va	Vg2	la	gm mA/V		
		SELECTOR SWITCH	TOP CAP	SELECTOR SWITCH	TOP CAP	V	V	V	V	mA	†Ra MΩ		
N31	207 331 800 0000	40		205 331 600	G1	13	4.4	200	175	40	10	B7	P
N34	107 231 800 0000	40		105 231 600	G1	13		250	250	40	10.5	B7	P
N37	412 380 700 0000	00		412 360 500		13	8	200	150	50	10	B7G	P
N40	047 231 800 0000	00		045 231 600		4	3.5	250	250	32	2.9	B7	P
N41	047 231 800 0000	00		045 231 600		4	3.5	250	250	32	10	B7	P
N42	047 231 800 0000	00		045 231 600		4	16.5	250	250	34	2.5	B7	P
N43	007 231 800 0000	40		005 231 600	G1	4(5)	4.5	250	250	40	10	B7	P
N63	028 740 310 0000	00		026 540 310		6.3	16.5	250	250	34	2.5	AO8	P
N66	028 740 310 0000	00		026 540 310		6.3	15	250	250	85	6.3	AO8	P
N77	412 380 700 0000	00		412 360 500		6.3	12	250	250	20	2.6	B7G	P
N78	412 380 700 0000	00		412 360 500		6.3	5.5	250	250	35	10	B7G	P
N108	412 380 700 0000	00		412 36* 500		40	8	200	150	50	10	B7G	P
N118	230 074 130 0000	00		23* *54 130		40	6	150	150	30	7.5	B9A	P
N119	041 230 807 0000	00		*41 23* 6*5		45	12.5	200	175	70	10	B9A	P
N142	281 074 130 0000	00		261 054 130		45	9.5	200	175	54.5	9.5	B8A	P
N144	412 380 700 0000	00		412 360 500		6.3	12	250	250	20	2.6	B7G	P
N145	281 074 130 0000	00		261 054 130		40	6.3	200	150	29	7.5	B8A	P
N147	028 740 310 0000	00		026 540 310		6.3	6	250	250	36		AO8	P
N148	287 004 130 0000	00		265 004 130		6.3	12.5	250	250	45	9.4	B8A	P
N150	281 074 130 0000	00		261 054 130		6.3	7	250	250	36	10	B8A	P
N151	281 047 130 0000	00		261 045 130		6.3	13.5	250	250	22.5	2.9	B8A	P
N152	041 230 071 0000	80		*41 23* *51	A1	20	28	200	200	40	6	B9A	P
N153	741 231 800 0000	00		541 231 600		5	2.3	200	175	36	10	B9A	P
N154	041 230 807 0000	00		*41 23* 6*5		16	14.2	200	200	45	8.2	B9A	P
N155	441 231 817 0000	00		441 231 615		6.3	10.8	225	225	26	3.2	B9A	P
N308	020 740 310 0000	80		02* 54* 310	A1	25	8.2	100	100	100	14	AO8	P
N309	741 231 800 0000	00		541 231 600		15	2.3	200	175	36	10	B9A	P
N339	041 230 071 0000	80		*41 23* *51	A1	21.5	13	150	150	50	8.5	B9A	P
N349	041 230 071 0000	80		*41 23* *51	A1	20	12	150	150	5	8.5	B9A	P
N369	041 230 807 0000	00		041 23* 6*5		12.6	10.3	200	175	31	8.3	B9A	P
N379	041 230 807 0000	00		*41 23* 6*5		15		200	175	70	10	B9A	P
N709	041 230 807 0000	00		*41 23* 6*5		6.3	7.3	250	250	48	11.3	B9A	P
N727	412 387 400 0000	00		412 365 400		6.3	4.5	250	250	45	4.1	B7G	P
NDD40	902 310 000 0000	00		802 310 000		4						B4	D
NEP51	023 110 780 0000	40		023 110 560	G1	4	3	250	100	8	2.2	8SC	P
NF2	023 110 780 0000	40		023 110 560	G1	12.5	2	200	100	3	2.1	8SC	P
NF3	023 110 780 0000	40		023 110 560	G1	12.5	2	200	100	4.5	2.3	8SC	P
NG320	002 300 000 0000	90		002 400 000	D1	2						B5	D
NG3020	002 300 000 0000	90		002 300 000	D1	2				5		B4	R
NHP51	023 100 780 0000	40		023 100 560	G1	4	2.5	250	100	3.5	2	8SC	P
NLP61	023 104 780 0000	00		023 104 560		4	7	250	250	4	9	8SC	P
NLP62	020 314 780 0000	00		020 314 560		4	14	250	250	72	9	8SC	P
NSS42	742 310 000 0000	80		542 310 000	A1	4	2.5	250	100	3.5	2	B5	P
NSS183	742 310 000 0000	80		542 310 000	A1	20	2.5	200	100	3.5	2	B5	P
NT51	023 100 080 0000	40		023 100 060	G1	4	5	250		6	2.5	8SC	T
NVS4	742 310 000 0000	80		542 310 000	A1	4	2	200	100	6	1	B5	P
NW4	842 310 000 0000	00		642 310 000		4	2.5	200		2.5	1	B5	T
OO	384 200 000 0000	00		364 200 000		5		40		1	0.6	UX4	T
O1	384 200 000 0000	00		364 200 000		5	4.5	90		2.5		UX4	T
O1AA	384 200 000 0000	00		364 200 000		5	4.5	90		3.2	0.9	UX4	T

SPEC.	VALVE TYPE NUMBER	PIN CONNECTIONS				CHARACTERISTICS						BASE	VALVE CLASS
		VCM163 Tester Only		CT160, VT160, VCM Mk 1,2,3,4		Vh	Vg1	Va	Vg2	Ia	gm mA/V		
		SELECTOR SWITCH	TOP CAP	SELECTOR SWITCH	TOP CAP	V	V	V	V	mA	†Ra MΩ		
	O15/400	842 300 000 0000	00	642 300 000		4	35	400		40	4.5	B4	T
	O54V	842 310 000 0000	00	642 310 000		4		100			4	B5	T
	O84	842 300 000 0000	00	642 300 000		4	4	150		4	1.3	B4	T
	O202	845 230 000 0000	00	645 230 000	G1	2		150	50	2		B7	O
	O202	845 230 000 0000	00	645 230 000	G1	2		150	75	0.95	0.2	B7	O
	O406	845 231 X00 0000	00	645 231 700	G1	4	4	90	90	2	1	B7	O
	O406	845 231 X00 0000	00	645 231 700	G1	4	4	250	90	1.6	1	B7	O
	O1307	023 174 780 0000	40	023 154 560	G1	4	1.5	200	90	8	3	8SC	P
	OBC3	041 9X8 231 0000	00	041 896 231		12.5	2	250		1	1.1	AO8	DDT
	OBF2	208 791 X30 0000	40	206 571 930	G1	9	2	200	100	6	1.8	AO8	DDP
	OCH4	218 741 830 0000	50	217 544 630	G1	15		100		3.5		AO8	TH
	OCH4	218 741 830 0000	50	217 544 630	G1	15	2	200	100	3	0.75	AO8	TH
	OF1	028 710 310 0000	40	026 510 310	G1	6.3	3	250	100	8.5	1.8	AO8	P
	OF9	209 701 130 0000	40	206 510 130	G1	8.5	2.5	200	100	6	2.2	AO8	P
	OM1	020 090 310 0000	00	020 080 310		30				120		AO8	R
	OM3	029 1X0 310 0000	00	028 190 310		6.3						AO8	DD
	OM4	028 X90 310 0000	40	026 980 310	G1	6.3	5	250		5.5	2.2	AO8	DDT
	OM5	028 710 310 0000	40	026 510 310	G1	6.3	2	250	100	3	1.8	AO8	P
	OM5C	028 710 310 0000	40	026 510 310	G1	6.3	2	250	100	3	1.8	AO8	P
	OM6	028 710 310 0000	40	026 510 310	G1	6.3	2.5	250	100	6	2	AO8	P
	OM9	028 700 310 0000	40	026 500 310	G1	6.3	18	260	250	32	2.8	AO8	P
	OM10	028 748 310 0000	50	027 546 310	G1	6.3	2.0	100		5.4	2.2	AO8	TH
	OM10	028 750 310 0000	50	027 546 310	G1	6.3	2.0	250	100	5.0	2.4	AO8	TH
	OP41	047 231 800 0000	00	045 231 600		4	12.5	250	250		9.1	B7	P
	OP42	047 231 800 0000	00	045 231 600		4	6.2	250	250		10.5	B7	P
	OS6/300	842 370 000 0000	00	642 350 000		4	20	300	150	22	2	B5	P
	OS18/600	023 114 700 0000	80	023 114 500	A1	6.3	14	250	275	72	8.5	8SC	P
	OSW2190	021 417 380 0000	00	021 415 360		6.3	2	300	150	10	9	AO8	P
	OSW2192	120 417 380 0000	00	120 415 360		6.3	3	300	150	30	11	AO8	P
	OSW3105	041 9X8 230 0000	00	041 896 230		6.3	2	250		0.9	1.1	AO8	DDT
	OSW3106	028 740 310 0000	00	026 540 310		6.3	12.5	250	250	45	4.1	AO8	P
	OSW3107	020 90X 030 0000	00	020 809 030		5				60		AO8	RR
	OSW3108	028 740 310 0000	00	026 540 310		6.3	14	250	250	72	6	AO8	P
	OSW3109	029 1X0 300 0000	00	028 190 300		6.3						AO8	DD
	OSW3111	021 417 380 0000	00	021 415 360		6.3	3	250	100	9.2	2	AO8	P
	OSW3112	028 040 310 0000	00	026 040 310		6.3	8	250		9	2.6	AO8	T
	P2	842 300 000 0000	00	642 300 000		2	6	100		12	3.5	B4	T
	P4	842 300 000 0000	00	642 300 000		4	21	250		30	2.8	B4	T
	P6M0	023 104 780 0000	00	023 104 560		6.3	14	250	250	72	9	8SC	P
	P12/250	842 300 000 0000	00	642 300 000		4	44	250		60	6	B4	T
	P15/250	842 300 000 0000	00	642 300 000		4	44	250		60	6	B4	P
	P15/250S	023 004 080 0000	00	023 004 060		4	44	250		60	6	8SC	T
	P24/450	842 300 000 0000	00	642 300 000		7.5	70	400		55	2.1	B4	T
	P25/400	842 300 000 0000	00	642 300 000		6.3	100	350		70	3.7	B4	T
	P25/500	842 300 000 0000	00	642 300 000		6.3	90	400		65	3	B4	T
	P26/500	842 300 000 0000	00	642 300 000		4	100	400		62.5	4.2	B4	T
	P27/500	842 300 000 0000	00	642 300 000		4	27	400		62.5	8.5	B4	T
	P30/500	842 300 000 0000	00	642 300 000		4	100	400		60	4	B4	T
	P41	218 040 030 0000	00	216 040 030		4	11.8	250		16	4.5	M08	T
	P43M	842 370 000 0000	00	642 350 000		4	17	250	250	26	2.5	B5	P
	P61	218 040 030 0000	00	216 040 030		6.3	11.8	250		16	4.5	M08	T

SPEC.	VALVE TYPE NUMBER	PIN CONNECTIONS				CHARACTERISTICS						BASE	VALVE CLASS
		VCM163 Tester Only		CT160, VT160, VCM Mk 1,2,3,4		Vh	Vg1	Va	Vg2	Ia	gm mA/V		
		SELECTOR SWITCH	TOP CAP	SELECTOR SWITCH	TOP CAP	V	V	V	V	mA	†Ra MΩ		
	P215	842 300 000 0000	00	642 300 000		2		150			1.4	B4	T
	P220	842 300 000 0000	00	642 300 000		2	7.5	150		6	3	B4	T
	P220A	842 300 000 0000	00	642 300 000		2	14	150		15	2.7	B4	T
	P222	842 300 000 0000	00	642 300 000		2	10.5	150		6	3	B4	T
	P225	842 370 000 0000	00	642 350 000		2	4.5	150	150	5.6	2.2	B5	P
	P240	842 300 000 0000	00	642 300 000		2	24	150		18	1.1	B4	T
	P240A	842 300 000 0000	00	642 300 000		2	21	150		25	5	B4	T
	P310	287 013 000 0000	40	265 013 000	G1	10	3	150	150	5.5	1.8	UX6	P
	P410	842 300 000 0000	00	642 300 000		4	12	150		7	1.3	B4	T
	P414	842 300 000 0000	00	642 300 000		4	16	100		14	2.8	B4	T
	P415	842 300 000 0000	00	642 300 000		4	25	150		14	1.5	B4	T
	P420	842 300 000 0000	00	642 300 000		4	85	400		50	6	B4	T
	P421	842 370 000 0000	00	642 350 000		4	11	200	75	12	1.5	B5	P
	P422	842 370 000 0000	00	642 350 000		4	20	250	250	22	2.5	B5	P
	P425	842 370 000 0000	00	642 350 000		4	25	300	200	20	1.7	B5	P
	P425	842 370 000 0000	00	642 300 000		4	16.5	150		17	1.9	B4	T
	P430	284 300 000 0000	00	264 300 000		4	30	200		25	2.2	UX4	T
	P434	032 004 780 0000	00	032 004 560		4	17	250	250	36	2.5	8SC	P
	P435	842 370 000 0000	00	642 350 000		4	17	250	250	30	3	B5	P
	P440	842 370 000 0000	00	642 350 000		4	30	400	200	45	5	B5	P
	P440N	842 310 000 0000	00	045 231 600		4	22	250	250	26	2.8	B7	P
	P440N	047 231 800 0000	00	642 310 000		4		250	250	20	2.5	B5	P
	P441N	047 231 800 0000	00	045 231 600		4	22	250	250	36	2.8	B7	P
	P455	284 300 000 0000	00	264 300 000		4	15	250		30	5.5	UX4	T
	P455	023 100 870 0000	00	023 100 650		4	25	250	250	36	2.6	8SC	P
	P460	842 300 000 0000	00	642 300 000		4	40	200		50	3.5	B4	T
	P469	047 231 800 0000	00	045 231 600		4	14	250	275	72	8.5	B7	P
	P495	047 231 800 0000	00	045 231 000		4	6	200	200	32		B7	P
	P496	047 231 800 0000	00	045 231 600		4	6	200	200	32	9.5	B7	P
	P520	842 370 000 0000	00	642 350 000		5	17	200	150	12	1.3	B5	P
	P625	842 300 000 0000	00	642 300 000		6.3	26	250		24	2.5	B4	T
	P625A	842 300 000 0000	00	642 300 000		6.3	39	200		25	2.3	B4	T
	P625B	842 300 000 0000	00	642 300 000		6.3	1	200			2.8	B4	T
	P626	023 100 780 0000	40	023 100 560	G1	6.3	32	250	250	26	2.5	8SC	P
	P628	023 100 780 0000	40	023 100 560	G1	6.3	17	250	250	56	2.5	8SC	P
	P650	842 300 000 0000	00	642 300 000		6.3	1	100		37	2.7	B4	T
	P861	29X 130 000 0000	00	289 130 000		6.3				30		UX5	RR
	P1320	023 100 780 0000	00	023 100 560		13	20	250	250	22	1.9	8SC	P
	P2018	842 310 000 0000	00	642 310 000		20	15	200		20	4	B5	T
	P2020N	842 310 000 0000	70	642 310 000	G2	20	18	200	200	20	1.7	B5	P
	P2060	023 140 780 0000	00	023 140 560		24	19	200	100	40	3.2	8SC	P
	P2460	842 310 000 0000	70	642 310 000	G2	24	19	200	100	40		B5	P
	P3580	047 231 800 0000	00	045 231 600		33	8.5	200	200	45	8	B7	P
	P4100	842 300 000 0000	00	642 300 000		4	40	400		30		B4	T
	PA20	842 300 000 0000	00	642 300 000		2	36	300		49	5.2	B4	T
	PA1	842 310 000 0000	00	642 310 000		4	10	200		40	5	B5	P
	PA40	842 300 000 0000	00	642 300 000		4	90	400		200	10	B4	T
	PAB1	023 1Y0 X90 0000	00	023 110 980		6.3						8SC	DDD
	PABC80	YX1 239 148 0000	00	191 238 146		9.5	2.3	200		1	1.4	B9A	DDDT
	PB1	234 800 000 0000	00	234 600 000		2	4	150		11.5	3.8	B4	T

SPEC.	VALVE TYPE NUMBER	PIN CONNECTIONS				CHARACTERISTICS						BASE	VALVE CLASS
		VCM163 Tester Only		CT160, VT160, VCM Mk 1,2,3,4		Vh	Vg1	Va	Vg2	la	gm mA/V		
		SELECTOR SWITCH	TOP CAP	SELECTOR SWITCH	TOP CAP	V	V	V	V	mA	†Ra MΩ		
	PB495	9X2 300 000 0000	00	892 300 000		4				30		B4	RR
	PBF2	028 9X7 310 0000	40	026 895 310	G1	6.3	3	250	100	5.8	1.2	AO8	DDP
	PC86	841 234 148 0000	00	641 234 146		3.8	1.5	200		12	14	B9A	T
□	PCC88	841 238 510 0000	00	641 237 510		6.3	1.2	90		15	12.5	B9A	TT
	PC92	802 304 100 0000	00	602 304 100		3.2	2	250		10	5	B7G	T
	PC93	842 314 800 0000	00	642 314 600		4.7	4	100		16	8	B9A	P
	PC95	142 380 100 0000	00	142 360 100		3.6	1.2	200		10	10.5	B7G	T
	PC96	412 314 800 0000	00	412 314 600		3.1	1	200		11.5	6.7	B7G	T
	PC97	142 380 100 0000	00	142 360 100		4.5	1	150		14	16	B7G	T
	PC900	412 380 100 0000	00	412 360 100		4	1	150		12	15	B7G	T
	PCC84	158 234 118 0000	00	147 234 116		7	3.0	90		14	6	B9A	TT
	PCC85	841 238 510 0000	00	641 237 410		9	2.1	200		10	5.8	B9A	TT
□	PCC88	841 238 510 0000	00	641 237 510		6.3	1.2	90		15	12.5	B9A	TT
	PCC89	148 235 118 0000	00	147 234 116		7.2	1.2	90		15	12	B9A	TT
	PCC186	841 228 513 0000	00	641 227 413		7.2	8.5	250		10.5	2.2	B9A	TT
	PCC189	841 238 510 0000	00	641 237 410		7.6	1.4	90		15	12.5	B9A	TT
	PCC805	148 235 118 0000	00	146 234 117		7	1.2	90		15	9	B9A	TT
	PCC806	148 235 118 0000	00	146 234 117		7	1.2	90		15	16.5	B9A	TT
	PCE80	841 238 751 0000	00	641 237 541		10		200		10	3.4	B9A	TP
	PCE80	841 238 751 0000	00	641 237 541		10		200	200	10	12.5	B9A	TP
	PCE82	841 238 751 0000	00	641 237 541		10	4.9	150		10	3.7	B9A	TP
	PCE82	841 238 751 0000	00	641 237 541		10	2.9	200	200	10	12.5	B9A	TP
	PCE800	841 238 751 0000	00	641 237 541		9.4	7.8	200		10	3.4	B9A	TP
	PCE800	841 238 751 0000	00	641 237 541		9.4	2.7	200	200	10	7.5	B9A	TP
	PCF80	857 238 114 0000	00	645 237 114		9	2	100		14.0	5.0	B9A	TP
	PCF80	857 238 114 0000	00	645 237 114		9	2.0	200	175	10.0	6.2	B9A	TP
	PCF82	857 238 114 0000	00	645 237 114		9.5	1.0	150	0	18	8.5	B9A	TP
	PCF82	857 238 114 0000	00	645 237 114		9.5	1.0	250	100	10	5.2	B9A	TP
	PCF84	415 238 718 0000	00	576 234 141		9	2	100		14	2.5	B9A	TP
	PCF84	415 238 718 0000	00	576 234 141		9	0	200	175	8	2.5	B9A	TP
	PCF86	151 234 887 0000	00	141 234 675		8	3	100		14	6	B9A	TP
	PCF86	151 234 887 0000	00	141 234 675		8	1.2	200	150	10	12	B9A	TP
	PCF87	178 238 415 0000	00	157 236 414		7.4	3.2	100		15	8.5	B9A	TP
	PCF87	178 238 415 0000	00	157 236 414		7.4	2.5	125	125	10	11	B9A	TP
	PCF200	114 123 878 5000	00	114 123 756	Adap13C	8	1	175		8.5	5	B10B	TP
	PCF200	114 123 878 5000	00	114 123 756	Adap13C	8	1.7	160	135	13	12	B10B	TP
	PCF800	178 238 415 0000	00	157 236 414		9	2.2	100		15	5	B9A	TP
	PCF800	178 238 415 0000	00	157 236 414		9	2.4	200	150	10	8.5	B9A	TP
	PCF801	151 238 784 0000	00	141 237 564		8.5	3	100		15	8.5	B9A	TP
	PCF801	151 238 784 0000	00	141 237 564		8.5	1.2	200	125	10	10.5	B9A	TP
	PCF802	857 238 114 0000	00	645 237 114		9.0	2.0	200		3.5	3.5	B9A	TP
	PCF802	857 238 114 0000	00	645 237 114		9.0	1.0	100	100	6.0	5.5	B9A	TP
	PCF803	151 238 784 0000	00	141 237 564		9	3	100		15	9	B9A	TP
	PCF803	151 238 784 0000	00	141 237 564		9		150	100	10	11	B9A	TP
	PCF805	878 231 514 0000	00	657 231 414		7.4	3	100		14	5.5	B9A	TP
	PCF805	878 231 514 0000	00	657 231 414		7.4	1.5	150	150	10	11	B9A	TP
	PCF806	151 238 784 0000	00	141 237 564		8	3	100		14	5.5	B9A	TP
	PCF806	151 238 784 0000	00	141 237 564		8	1.2	200	150	10	12	B9A	TP
	PCF808	878 231 514 0000	00	657 231 414		7.4	3	100		14	5.5	B9A	TP
	PCF808	878 231 514 0000	00	657 231 414		7.4	1.7	150	150	12	14.5	B9A	TP
	PCH200	114 723 851 8000	00	114 523 741	dap13A	9	1	100		9	8.8	B10B	TH
	PCH200	114 723 851 8000	00	114 523 741	dap13A	9	0	12.6	12.6	0.8		B10B	TH
	PCL81	471 238 815 0000	00	451 237 614		12.6	1.9	150		1.3	1.6	B9A	TP
	PCL81	471 238 815 0000	00	451 237 614		12.6	6.5	200	200	30	8.7	B9A	TP

SPEC.	VALVE TYPE NUMBER	PIN CONNECTIONS				CHARACTERISTICS						BASE	VALVE CLASS
		VCM163 Tester Only		CT160, VT160, VCM Mk 1,2,3,4		Vh	Vg1	Va	Vg2	la	gm mA/V		
		SELECTOR SWITCH	TOP CAP	SELECTOR SWITCH	TOP CAP	V	V	V	V	mA	†Ra MΩ		
	PCL82	415 238 718 0000	00	414 237 516		16	1.5	200		1.7	2.4	B9A	TP
	PCL82	415 238 718 0000	00	414 237 516		16	11	200	175	41	7.5	B9A	TP
	PCL83	841 238 175 0000	00	641 237 154		12.5	8.5	250	0	10.5	2.2	B9A	TP
	PCL83	841 238 175 0000	00	641 237 154		12.5	9.0	200	175	30	4.7	B9A	TP
	PCL84	481 238 157 0000	00	461 237 145		15	1.7	200		3	4	B9A	TP
	PCL84	481 238 157 0000	00	461 237 145		15	2.9	200	200	18	10	B9A	TP
	PCL85	841 238 715 0000	00	641 237 514		18	0.85	100		5	5.5	B9A	TP
	PCL85	841 238 715 0000	00	641 237 514		18	15	175	175	41	7	B9A	TP
	PCL86	417 238 158 0000	00	415 237 146		14.5	1.7	250		1.2	1.6	B9A	TP
	PCL86	417 238 158 0000	00	415 237 146		14.5	5.7	250	250	39	10.5	B9A	TP
	PCL88	415 238 718 0000	00	414 237 516		16	2.1	200		10	3.4	B9A	TP
	PCL88	415 238 718 0000	00	414 237 516		16		200	200			B9A	TP
	PCL200	841 123 875 0000	00	641 123 654		16	1.5	200		8.5	5.2	B10B	TP
	PCL200	841 123 875 0000	00	641 123 654		16	2.1	200	150	40	28	B10B	TP
	PCL800	415 238 718 0000	00	414 237 516		16	2.1	100		10	4.3	B9A	TP
	PCL800	415 238 718 0000	00	414 237 516		16	18	200	200	45	7.5	B9A	TP
	PCL805	841 238 715 0000	00	641 237 514		18	0.85	100		5	5.5	B9A	TP
	PCL805	841 238 715 0000	00	641 237 514		18	15	170	170	41	7	B9A	TP
	PC03/3A	023 014 700 0000	80	023 014 500	A1	2		300	125		1.4	8SC	P
	PC03/3B	023 014 700 0000	80	023 014 500	A1	4		300	125		1.4	8SC	P
	PC05/15	023 014 700 0000	80	023 014 500	A1	4		400	250	40	1.3	8SC	P
	PD220	548 230 800 0000	00	446 230 700		2	1.2	150		0.8	0.9	B7	TT
	PD220A	548 230 800 0000	00	446 230 700		2	3	140		5	1.5	B7	TT
	PD500	100 230 040 0000	80	1** 230 040	A1	7.3	10	400		1.6	0.14	B9D	T
	PDD2	284 79X 130 0000	00	264 589 130		6.3	6	250	250	36	9	AO8	DDP
	PE04-10	023 114 700 0000	80	023 114 500	A1	12		400	300	27	7.5	8SC	P
	PE05-15	023 114 700 0000	80	023 114 500	A1	12				40	1.5	8SC	P
	PE05-25	278 130 000 0000	80	256 130 000	A1	12.6	80	400	200	70		B5B	P
	PE06/40P	123 114 700 0000	80	123 114 500	A1	6.3	40	400	300	40	4	8SC	P
	PE1-100	247 811 300 0000	00	245 611 300		12	33	400	250	40	6	B7A	P
	Pen4DD	X19 238 700 0000	40	918 236 500	G1	4(5)	6	250	250	36	9.5	B7	DDP
	Pen4V	842 310 000 0000	70	642 310 000	G2	4	10	250	200	35	3	B5	P
	Pen4VA	047 231 800 0000	00	642 310 000	G2	4	22	250	250	36	2.8	B5	P
	Pen4VA	842 310 000 0000	70	045 231 600		4	20	250	250	36	2.8	B7	P
	Pen4VB	047 231 800 0000	00	045 231 600		4	5.8	250	250	36	9.5	B7	P
	Pen4VX	842 310 000 0000	70	642 310 000	G2	4	15	350	200	22	3.5	B5	P
	Pen13	023 100 780 0000	40	023 100 560	G1	13	14	200	200	25	2.5	8SC	P
	Pen13A	023 110 780 0000	40	023 110 560	G1	33	8.5	200	200	45	8	8SC	P
	Pen13C	047 231 800 0000	00	045 231 600		13	11	250	250	32	6.5	B7	P
	Pen20	842 310 000 0000	70	642 310 000	G2	20	18	200	200	20	1.7	B5	P
	Pen24	028 740 030 0000	00	206 540 030		2	3.3	200	125	5	4	M08	P
	Pen25	208 740 030 0000	00	206 540 030		2	3.6	200	125	5	3	M08	P
	Pen26	023 100 780 0000	40	023 100 560	G1	24	19	200	100	40	3.1	8SC	P
	Pen36A	145 231 800 0000	00	145 231 600		35	8.5	200	200	45	8	B7	P
	Pen36C	047 231 800 0000	00	045 231 600		33	8.5	200	200	45	8	B7	P
	Pen40DD	X19 238 700 0000	40	918 236 500	G1	44	8.5	200	200	45	8	B7	DDP
	Pen44	218 740 030 0000	00	216 540 030		4	11	300	275	70	10.6	M08	P
	Pen45	218 740 030 0000	00	216 540 030		4	8.5	250	250	49	8.8	M08	P
	Pen45DD	218 7X0 930 0000	40	216 590 830	G1	4	8.5	250	250	40	8.8	M08	DDP
	Pen46	210 740 030 0000	80	210 540 030	A1	4(5)	8	300	225	63	8.5	M08	P
	Pen141	208 740 030 0000	00	206 540 030		1.4	9	90	90	5.5	1.4	M08	P
	Pen220	842 370 000 0000	00	642 350 000		2	4.9	150	150	9	2.2	B5	P
	Pen220A	842 370 000 0000	00	642 350 000		2	9	150	150	18	2.2	B5	P
	Pen230	842 370 000 0000	00	642 350 000		2	4.5	150	125	6	2.2	B5	P



SPEC.	VALVE TYPE NUMBER	PIN CONNECTIONS				CHARACTERISTICS						BASE	VALVE CLASS
		VCM163 Tester Only		CT160, VT160, VCM Mk 1,2,3,4		Vh	Vg1	Va	Vg2	la	gm mA/V		
		SELECTOR SWITCH	TOP CAP	SELECTOR SWITCH	TOP CAP	V	V	V	V	mA	†Ra MΩ		
	Pen231	842 370 000 0000	00	642 350 000		2	2.5	150	125	5	4.4	B5	P
	Pen383	218 740 030 0000	00	216 540 030		38	10	200	175	64	10.5	M08	P
	Pen384	218 740 030 0000	00	216 540 030		38	7	150	125	40	7.8	M08	P
	Pen425	842 370 000 0000	00	642 350 000		4	25	300	200	20	1.7	B5	P
	Pen428	047 231 800 0000	00	045 231 600		4(5)	13.8	250	250	72	8.5	B7	P
	Pen453DD	218 7X0 930 0000	40	216 590 830	G1	45	10	200	175	64	10.5	M08	DDP
	Pen650	023 114 700 0000	80	023 114 500	A1	6.3	24	400	300	30	5	8SC	P
	Pen1340	047 231 800 0000	00	045 231 600		13	8.6	250	250	41	6.4	B7	P
	Pen2020	023 100 780 0000	40	023 100 560	G1	20	19	200	100	40	3.1	8SC	P
	Pen3520	047 231 800 0000	00	045 231 600		35	8	200	200	40	7.3	B7	P
	Pen3820	047 231 800 0000	00	045 231 600		38	10	150	175	64	10.5	B7	P
	PenA1	842 370 000 0000	00	642 350 000		4	16.5	250	250	32	3	B5	P
	PenA4	007 231 800 0000	00	005 231 600	G1	4	5.8	250	250	36	9.5	B7	P
	PenA4	047 231 800 0000	40	045 231 600		4	5	250	250	40	9.1	B7	P
	PenB1	842 370 000 0000	00	642 350 000		2	4.5	150	150	8.5	2.5	B5	P
	PenB4	047 231 800 0000	00	045 231 600		4(5)	14	250	275	72	8.5	B7	P
	PenDD61	98X 231 700 0000	40	869 231 500	G1	6.3	5.3	250	250	32	8.5	B7	DDP
	PenDD1360	X89 231 700 0000	40	968 231 500	G1	13	5.3	250	250	32	8.2	B7	DDP
	PenDD2530	98X 231 700 0000	40	869 231 500	G1	25	7.8	250	250	43	7.8	B7	DDP
	PenDD4020	X89 231 700 0000	40	968 231 500	G1	40	7.7	250	250	43	7.8	B7	DDP
	PenDD4021	X89 231 700 0000	40	968 231 500	G1	45	10	200	175	64	10.5	B7	DDP
	PF9	028 710 310 0000	40	026 510 310	G1	6.3	3.5	250	100	7.5	1.7	AO8	P
	PF83	701 238 014 0000	00	501 236 014		4.5	2	60	50	1.9		B9A	P
	PF86	701 238 014 0000	00	501 236 014		4.5	2	250	150	3	2	B9A	P
	PF462	041 230 700 0000	80	041 230 500	A1	2	1	150	150	3	1.9	B7	P
	PF472	041 230 700 0000	80	041 230 500	A1	2	0.5	150	150	2.5	1.7	B7	P
	PFL200	517 823 147 80000	00	415 623 145	Adap13A	216.5	2.6	175	175	30	21	B10B	PP
	PFL200	517 823 147 80000	00	415 623 145	dap13A	16.5	2.3	150	150	10	8.6	B10B	PP
	PL11	802 301 470 0000	00	602 301 450		17.5	10.5	200	200	53	9	F8	P
	PL33	028 740 310 0000	00	026 540 310		19	5.3	250	250	32	9	AO8	P
	PL36	020 740 310 0000	80	*20 540 310	A1	25	8.2	100	100	100	14	AO8	P
	PL38	120 740 310 0000	80	120 540 310	A1	30	5.5	200	200	75	13.5	AO8	P
	PL81	041 230 071 0000	80	*41 23* *51	A1	21.5	28	200	200	40	6	B9A	P
	PL81A	041 230 071 0000	80	*41 23* *51	A1	21.5	24.5	150	150	45	6	B9A	P
	PL81F	041 230 071 0000	80	*41 23* *51	A1	21.5	28	200	200	30	6	B9A	P
	PL82	041 230 807 0000	00	041 230 605		16	14.2	200	200	45	7.6	B9A	P
	PL83	741 231 800 0000	00	541 231 60*		15	2.3	200	175	36	10	B9A	P
	PL84	041 230 807 0000	00	*41 23* 6*5		15	12.5	200	175	70	10	B9A	P
	PL95	412 387 400 0000	00	412 365 400		4.5	9	250	250	24	5	B7G	P
	PL136	721 441 270 0000	80	521 441 450	A1	35	12	100	100	90	19	AO8	P
	PL183	741 231 840 0000	00	541 231 640		12.6	2.1	150	225	40	25	B9A	P
	PL300	721 441 370 0000	80	521 441 350	A1	35	22.5	200	150	100	10	B8A	P
	PL302	020 740 310 0000	80	02* 340 *310	A1	25	12	100	100	60	20	AO8	P
	PL500	441 237 710 0000	80	441 235 51*	A1	20	18	150	150	70	10	B9D	P
	PL502	441 237 710 0000	80	441 235 510	A1	35	30	200	200	100	2.0	B9D	P
	PL504	441 237 710 0000	80	441 235 510	A1	27	20	150	150	70	11	B9D	P
	PL505	417 237 141 0000	80	415 235 141	A1	40	35	150	150	100	10	B9D	P
	PL508	407 238 140 0000	00	4*5 236 14*		17.0	18	200	200	60	6	B9D	P
	PL509	407 237 041 0000	80	405 235 041	A1	40	37	160	160	80	14	B9D	P
	PL802	141 237 871 0000	00	141 235 651		16.0	0.9	170	170	30	40	B9A	P
	PL820	041 231 771 0000	80	041 231 551	A1	21.5	22	200	175	45	6.2	B9A	P

SPEC.	VALVE TYPE NUMBER	PIN CONNECTIONS				CHARACTERISTICS						BASE	VALVE CLASS
		VCM163 Tester Only		CT160, VT160, VCM Mk 1,2,3,4		Vh	Vg1	Va	Vg2	la	gm mA/V		
		SELECTOR SWITCH	TOP CAP	SELECTOR SWITCH	TOP CAP	V	V	V	V	mA	†Ra MΩ		
	PLL80	748 235 187 0000	00	546 234 175		12	9	250	250	24	6	B9A	PP
	PM04	412 387 100 0000	00	412 365 100		6.3	1.2	250	100	11	4.4	B7G	P
	PM05	412 387 100 0000	00	412 365 100		6.3	2.3	150	150	7	4.3	B7G	P
	PM07	412 381 700 0000	00	412 361 500		6.3	2	250	250	10	7.5	B7G	P
	PM1A	842 300 000 0000	00	642 300 000		2		100		1	1.2	B4	T
	PM1HF	842 300 000 0000	00	642 300 000		2	3	150		1.5	0.8	B4	T
	PM1HL	842 300 000 0000	00	642 300 000		2	1.5	150		2.3	1.2	B4	T
	PM1LF	842 300 000 0000	00	642 300 000		2	6	150		3	0.9	B4	T
	PM2	842 300 000 0000	00	642 300 000		2	7	100		4	0.9	B4	T
	PM2A	842 300 000 0000	00	642 300 000		2	6	160		5	2	B4	T
	PM2B	548 230 800 0000	00	446 230 700		2	1	150		3	2.5	B7	TT
	PM2DL	842 300 000 0000	00	642 300 000		2	4.5	150		2	1.5	B4	T
	PM2DX	842 300 000 0000	00	642 300 000		2	5	150		2.3	1.1	B4	T
	PM2HL	842 300 000 0000	00	642 300 000		2	1.5	150		2.2	1.4	B4	T
	PM3	842 300 000 0000	00	642 300 000		4		100		2	1.1	B4	T
	PM4DX	842 300 000 0000	00	642 300 000		4		100		1.5	2	B4	T
	PM5	208 748 130 0000	00	206 546 130		6.3	15	200	200		†1.0	AO8	TI
	PM5	208 748 130 0000	00	206 546 130		6.3	5	200	200		†1.0	AO8	TI
	PM12	742 300 000 0000	80	542 300 000	A1	2	0	150	75	4	1.1	B4	P
	PM12A	742 300 000 0000	80	542 300 000	A1	2	1	150	75	2	1.5	B4	P
	PM12M	742 300 000 0000	80	542 300 000	A1	2	1	150	90	1.4	1.4	B4	P
	PM12V	742 300 000 0000	80	542 300 000	A1	2		150	90		0.7	B4	P
	PM14	742 300 000 0000	80	542 300 000	A1	4		150	75	2.7	0.8	B4	P
	PM14V	742 300 000 0000	80	542 300 000	A1	4		150	75	2.7	0.8	B4	P
	PM14L	842 300 000 0000	00	642 300 000		2	1.5	150		2.3	1.2	B4	T
	PM22	842 370 000 0000	00	642 350 000		2	10	150	150	15	1.3	B5	P
	PM22A	842 370 000 0000	00	642 350 000		2	4.5	150	150	5.6	2.2	B5	P
	PM22C	842 370 000 0000	00	642 350 000		2	16	150	150	23	3	B5	P
	PM22D	842 370 000 0000	00	642 350 000		2	2.4	150	150	5	3	B5	P
	PM24	842 310 000 0000	70	642 310 000	G2	4	11	150	150	20	1.7	B5	P
	PM24A	842 370 000 0000	00	642 350 000		4	22.5	300	200	20		B5	P
	PM24B	842 370 000 0000	00	642 350 000		4	40	400	300	30	2.1	B5	P
	PM24C	842 370 000 0000	00	642 350 000		4	20	400	200		3	B5	P
	PM24D	842 370 000 0000	00	642 350 000		4(5)	35	400	200	50	4	B5	P
	PM24DC	842 370 000 0000	00	642 350 000		4(5)	42	300	200	20	1.5	B5	P
	PM24E	842 370 000 0000	00	642 350 000		4	40	300	300	83	3.9	B5	P
	PM24M	842 370 000 0000	00	642 350 000		4	17	250	250	30	3	B5	P
	PM84	401 237 808 0000	00	-		4.2	22	250	250	0.5		B9A	TI
	PM202	842 300 000 0000	00	642 300 000		2	14	150		14	3.5	B4	T
	PM252	842 300 000 0000	00	642 300 000		2	2	150		14	3.7	B4	T
	PM254	842 300 000 0000	00	642 300 000		4	21	200		15		B4	T
	PM256	842 300 000 0000	00	642 300 000		6.3	27	250		20		B4	T
	PN2	842 370 000 0000	00	642 350 000		2	7.5	150	150	6		B5	P
	PP2	842 300 000 0000	70	642 300 000	G2	2	5	150	150	7	2.1	B4	P
	PP2	842 370 000 0000	00	642 350 000		2	5	150	150	7	2.1	B5	P
	PP2S	023 004 780 0000	00	023 004 560		2	5	150	150	7	2.1	8SC	P
	PP3/250	842 300 000 0000	00	642 300 000		4	37	300		48	5.2	B4	T
	PP4	842 370 000 0000	00	642 350 000		4	15	250	250	36	3	B4	P
	PP4S	842 370 000 0000	00	032 004 560		4	15	250	250	36	3	8SC	P

SPEC.	VALVE TYPE NUMBER	PIN CONNECTIONS				CHARACTERISTICS						BASE	VALVE CLASS
		VCM163 Tester Only		CT160, VT160, VCM Mk 1,2,3,4		Vh	Vg1	Va	Vg2	la	gm mA/V		
		SELECTOR SWITCH	TOP CAP	SELECTOR SWITCH	TOP CAP	V	V	V	V	mA	†Ra MΩ		
	PP4S	032 004 780 0000	00	642 350 000		4	15	250	250	36	3	B5	P
	PP5/400	842 300 000 0000	00	642 300 000		4(5)	32	400		62	8.2	B4	T
	PP6AS	023 104 780 0000	00	023 104 560		6.3	18	250	250	32	2.8	8SC	P
	PP6B	287 413 000 0000	00	265 413 000		6.3	6	250	250	36	10	UX6	P
	PP6BG	028 740 310 0000	00	026 540 310		6.3	6	250	250	36	10	AO8	P
	PP6BS	028 740 310 0000	00	026 540 310		6.3	6	150	250	36	9	AO8	P
	PP6C	028 740 310 0000	00	026 540 310		6.3	12	250	200	36	10	AO8	P
	PP6E	047 231 800 0000	00	045 231 600		6.3	17	500	275	72	8.5	B7	P
	PP13A	047 231 800 0000	00	045 231 600		13	12	200	200	40	2.6	B7	P
	PP13S	023 100 780 0000	40	023 100 560	G1	13	14	200	200	25	3.5	8SC	P
	PP24	007 231 800 0000	40	005 231 600	G1	24	19	200	100	40	3	B7	P
	PP24S	023 100 780 0000	40	023 100 560	G1	24	19	200	100	40	3	8SC	P
	PP34	007 231 800 0000	40	005 231 600	G1	35	6.5	200	200	45	8.5	B7	P
	PP34S	023 100 780 0000	40	023 100 560	G1	35	6.5	200	200	45	8.5	8SC	P
	PP35	047 231 800 0000	00	045 231 600		35	6.5	200	200	45	8.5	B7	P
	PP36	147 231 800 0000	00	145 231 600		35	6.5	200	200	45	8.5	B7	P
	PP37	007 231 800 0000	40	005 231 600	G1	35	9.5	200	100	45	8.5	B7	P
	PP60	028 740 310 0000	00	026 540 310		6.3	15	250	250	85	6.3	AO8	P
	PP215	842 370 000 0000	00	642 350 000		2	4.5	90	90	8	1.7	8SC	P
	PP215S	032 004 780 0000	00	032 004 560		2	4.5	90	90	8	1.7	8SC	P
	PP220	842 300 000 0000	00	642 300 000		2	12	150		12.5	3	B4	T
	PP222	842 370 000 0000	00	642 350 000		2	6	150	150	12	2.5	B5	P
	PP225	842 370 000 0000	00	642 350 000		2	12	150	150	18	2	B5	P
	PP225S	023 004 780 0000	00	023 004 560		2	12	150	125	18	2	8SC	P
	PP415	842 370 000 0000	00	642 350 000		4	12	200	200	12	1.8	B5	P
	PP416	842 370 000 0000	00	642 350 000		4	12	200	75	10	2	B5	P
	PP430	842 370 000 0000	00	642 350 000		4	25	200	200	20	2	B5	P
	PP431	842 370 000 0000	00	642 350 000		4	20	250	250	22	1.9	B5	P
	PP472	041 230 700 0000	80	041 230 500	A1	2	0.5	150	150	2.5	1.7	B7	P
	PP2018	842 310 000 0000	70	642 310 000	G2	20	18	200	200	20	2.5	B5	P
	PP2018	047 231 800 0000	00	045 231 600		20	18	200	200	20	2.5	B7	P
	PP2101	384 720 000 0000	00	364 520 000		2	3	150	150	7	2.1	UX5	P
	PP3521	040 231 800 0000	00	040 231 600		35	25	200		70	6.3	B7	T
	PP4100	842 370 000 0000	00	642 350 000		4	40	400	300	30	3	B5	P
	PP4101	842 370 000 0000	00	642 350 000		4	14	250	250	36	3.5	B5	P
	PP4118	180 472 300 0000	00	160 452 300		40	10	200	175	35	6.5	C7	P
	PT	047 231 800 0000	00	045 231 600		4	6	250	250	32.5	7.5	B7	P
	PT2	842 370 000 0000	00	642 350 000		2	4.5	150	125	5.3	2.6	B5	P
	PT2	842 300 000 0000	70	642 300 000	G2	2	4.5	150	150	6.5	2.5	B4	P
	PT2A	842 370 000 0000	00	642 350 000		2	10.5	150	150	18		B5	P
	PT2K	842 370 000 0000	00	642 350 000		2	4.5	150	150	9.5	2.5	B5	P
	PT4	842 370 000 0000	00	642 350 000		4	17	250	250	30	3	B5	P
	PT4	047 231 800 0000	00	045 231 600		4	6	250	250	36	9.5	B7	P
	PT4	218 047 300 0000	00	216 045 300		4	6	250	250	31	7	B7	P
	PT4D	X89 231 700 0000	40	968 231 500	G1	4	6	250	250	32.5	7.5	B7	DDP
	PT5	047 231 800 0000	00	045 231 600		26	7	250	250	36	9	B7	P
	PT10	047 231 800 0000	00	045 231 600		3	7.5	250	250	40	9	B7	P
	PT12	204 731 102 0000	80	204 531 102	A1	10	15	250	250	62	6	B9	P
	PT15	742 310 000 0000	80	542 310 000	A1	6.3	25	300	300	40	2.8	B5	P
	PT16	842 370 000 0000	00	642 350 000		4	15	300	300	55	4.8	B5	P

SPEC.	VALVE TYPE NUMBER	PIN CONNECTIONS				CHARACTERISTICS						BASE	VALVE CLASS
		VCM163 Tester Only		CT160, VT160, VCM Mk 1,2,3,4		Vh	Vg1	Va	Vg2	la	gm mA/V		
		SELECTOR SWITCH	TOP CAP	SELECTOR SWITCH	TOP CAP	V	V	V	V	mA	†Ra MΩ		
	PT25	842 370 000 0000	00	642 350 000		4	22	400	200	62	4	B5	P
	PT25H	842 370 000 0000	00	642 350 000		5	16	400	300	62	6.5	B5	P
	PT41	842 370 000 0000	00	642 350 000		4	12.5	250	200	30	3	B5	P
	PT41B	842 370 000 0000	00	642 350 000		4	40	400	300	30	2.2	B5	P
	PT225	842 370 000 0000	00	642 350 000		2	6	150	150	8	2.3	B5	P
	PT225	842 300 000 0000	70	642 300 000	G2	2	6	150	150	8	2.3	B4	P
	PT240	842 370 000 0000	00	642 350 000		2	9	150	150	16	2.5	B5	P
	PT250	842 370 000 0000	00	642 350 000		2	15	250	250	40		B5	P
	PT425	842 370 000 0000	00	642 350 000		4	7.5	150	150	15	2	B5	P
	PTA	047 231 800 0000	00	045 231 600		13	10	250	250	32	4	B7	P
	PTAD	X89 231 700 0000	40	968 231 500	G1	4	6	250	250	7	7	B7	DDI
	PTE11	287 004 130 0000	00	265 004 130		18	3	210	210	20	11	B8G	P
	PTS	047 231 800 0000	00	045 231 600		26	5.5	250	250	40	6	B7	P
	PTS	007 231 800 0000	40	005 231 600	G1	26	8.2	250	250	32	6	B7	P
	PTSA	98X 231 700 0000	40	869 231 500	G1	26	5.5	200	200	40		B7	DDI
	PTSD	X89 231 700 0000	40	968 231 500	G1	26	5	250	200	40	6	B7	DDI
	PTT120P	841 238 510 0000	00	641 237 410		18	1.5	250		10	5.5	B8D	TT
	PTT141	802 441 443 0000	00	602 441 443		6.3	1.2	150		22	25	B9A	T
	PTT202	412 378 010 0000	00	412 356 010		18	2.2	200	200	8	5.5	B8D	P
	PTT203	028 710 310 0000	40	026 510 310	G1	18	5	200	200	35	8.5	AO8	P
	PTT203P	028 700 310 0000	40	026 500 310	G1	18	5	200	200	35	8.5	AO8	P
	PTT208P	412 378 110 0000	00	412 356 110		18	4.5	200	200	18	6	B8D	P
	PTT212P	412 378 010 0000	00	412 356 010		18	1.6	200	200	10.5	8.5	B8D	P
	PTT213P	412 378 010 0000	00	412 356 010		6.3	1.6	200	200	10.5	8.5	B8D	P
	PTT214P	412 387 110 0000	00	412 365 110		6.3	1.8	150	150	12.5	13.5	B8D	P
	PTT216	402 108 073 0000	00	402 106 053		6.3	1.8	150	150	12.5	13.5	B8D	P
	PTT217	123 141 718 0000	00	123 141 516		6.3	1.6	150	150	12.5	16	B9A	P
	PTT241P	412 378 000 0000	00	412 356 *00		6.3	2.9	250	225	34	12.5	B8D	P
	PTT243P	421 378 130 0000	00	421 356 130		6.3	1.5	150	150	26	28	B8D	P
	PTT244P	817 141 230 0000	00	615 141 230		18	1.5	150	150	26	27	B8D	P
	PTZ	007 231 800 0000	40	005 231 600	G1	40	5.5	250	200	40	7.5	B7	P
	PV06-20	400 237 100 0000	80	400 235 100	A1	6.3	40	200	300	40	4	B7	P
	PV06-25	401 237 100 0000	80	401 235 100	A1	6.3	40	200	300	40	4	B7	P
	PV1-35	401 237 100 0000	80	401 235 100	A1	12	25	250	200	40	2	B7	P
	PV4	9X2 300 000 0000	00	892 300 000		4				60		B4	RR
	PV25	0X1 231 900 0000	00	091 231 800		25				60		B7	RR
	PV29	0X1 231 900 0000	00	091 231 800		30				60		B7	RR
	PV29S	123 190 0X0 0000	00	123 180 090		30				60		8SC	RR
	PV30	0X1 231 900 0000	00	091 231 800		30				30		B7	RR
	PV30A	123 190 0X0 0000	00	123 180 090		30				30		8SC	RR
	PV30S	123 1X0 090 0000	00	123 190 080		30				60		8SC	RR
	PV75/1000	9X2 300 000 0000	00	892 300 000		4				30		B4	RR
	PV200/600	9X2 300 000 0000	00	892 300 000		4				120		B4	RR
	PV400	902 300 000 0000	00	802 300 000		4				30		B4	R
	PV430	9X2 300 000 0000	00	892 300 000		4				15		B4	RR
	PV3018	1X0 912 300 0000	00	190 812 300		30				60		C7	RR
	PVB6	9X2 310 000 0000	00	892 310 000		6.3				60		B5	RR
	PX2	842 300 000 0000	00	642 300 000		2	22	150		22	1.5	B5	T
	PX4	842 300 000 0000	00	642 300 000		4	43	300		43	6	B4	T
	PX5	842 300 000 0000	00	642 300 000		4	34	400		62.5	6.5	B4	T

SPEC.	VALVE TYPE NUMBER	PIN CONNECTIONS				CHARACTERISTICS						BASE	VALVE CLASS
		VCM163 Tester Only		CT160, VT160, VCM Mk 1,2,3,4		Vh	Vg1	Va	Vg2	la	gm mA/V		
		SELECTOR SWITCH	TOP CAP	SELECTOR SWITCH	TOP CAP	V	V	V	V	mA	†Ra MΩ		
	PX25	842 300 000 0000	00	642 300 000		4(5)	31	400		40	7.5	B4	T
	PX25A	842 300 000 0000	00	642 300 000		4(5)	100	400		62.5	3.7	B4	T
	PX41	842 300 000 0000	00	642 300 000		4	40	250		49	6	B4	T
	PX230	842 300 000 0000	00	642 300 000		2	15	150		17.5	3.5	B4	T
	PX230SW	802 300 000 0000	40	602 300 000	G1	2	15	150		18	3.5	B4	T
	PX240	842 300 000 0000	00	642 300 000		2	32	200		25	3	B4	T
	PX2100	842 300 000 0000	00	642 300 000		7.5	30	400		18	1.6	SM4	T
	PY31	020 090 310 0000	00	020 080 310		17				120		AO8	R
	PY32	029 090 310 0000	00	026 060 310		29				180		AO8	R
	PY71	200 900 030 0000	10	200 800 030	C	21				120		B8B	R
	PY80	001 230 009 0000	00	001 230 008		19				180		B9A	R
	PY81	000 230 009 0000	10	*** 23* **8	C	17				120		B9A	R
	PY82	001 230 009 0000	00	**1 23* **8		19				180		B9A	R
	PY83	000 230 009 0000	10	*** 23* **8	C	20				120		B9A	R
	PY88	000 230 009 0000	10	*** 23* **8	C	26				120		B9A	R
	PY300	029 090 310 0000	00	028 08* 310		29				180		AO8	R
	PY500	090 230 099 0000	10	*8* 23* 88*	C	42		10		150		B9D	D
	PY500A	090 230 990 0000	10	*8* 23* 88*	C	42		10		150		B9D	D
	PY800	000 230 009 0000	10	**1 23* **6	C	19				120		B9A	R
	PY801	000 230 009 0000	10	**1 23* **6	C1	19				170		B9A	R
	PZ	284 730 000 0000	00	264 530 000		2.5	16.5	250	250	31	2.5	UX5	P
	PZ03-3	401 237 000 0000	80	401 235 000	A1	4	25	300	125	25	1.4	B7	P
	PZ05-15	401 237 000 0000	80	401 235 000	A1	4		400	150	40	1.2	B7	P
	PZ30	02X 193 210 0000	00	029 183 210		26				120		AO8	RR
	PZH	287 413 000 0000	00	265 413 000		2.5	16.5	250	250	34	2.2	UX6	P
	QA2400	412 381 700 0000	00	412 361 500		6.3	2.5	200	200	8	2.5	B7G	P
	QA2401	802 384 100 0000	00	6*2 364 100		6.3	8.5	250		10.5	2.2	B7G	T
	QA2402	412 380 700 0000	00	412 36* 500		6.3	13.5	250	250	16	2.6	B7G	P
	QA2403	412 381 700 0000	00	412 361 500		6.3	2.0	250	250	10.0	7.5	B7G	P
	QA2403	412 381 700 0000	00	412 361 500		6.3	1.6	200	150	4.0	6.4	B7G	P
	QA2404	1X2 310 900 0000	00	192 310 800		6.3				3		B7G	DD
	QA2405	241 878 153 0000	00	241 657 143		6.3	14	250	150	30	3.9	B9G	PP
	QA2406	581 228 413 0000	00	471 226 413		6.3	2	250		10	5.5	B9A	TT
	QA2407	902 30X 100 0000	00	802 309 100		6.3				30		B7G	RR
	QA2408	581 481 230 0000	00	471 461 230		6.3	8	250		9	2.6	AO8	TT
	QB65	481 581 230 0000	00	461 471 230		6.3	8	250		9	2.6	AO8	TT
	QB309	841 228 513 0000	00	641 227 413		6.3	2	250		10	5.5	B9A	TT
	QB329	X41 228 413 0000	00	741 226 413		12.6	8.5	250		10.5	2.2	B9A	TT
	QB339	X41 228 413 0000	00	741 226 413		12.6	2	250		1.2	1.6	B9A	TT
	QC05/35	237 242 300 0000	80	235 242 300	A1	1.6		200	200	100	7	AO8	P
	QD77	192 310 X00 0000	00	182 310 900		6.3						B7G	DD
	QE04/10	287 711 413 0000	00	265 511 413		6.3	12	300	150	25	1.9	B9G	P
	QE05	127 141 300 0000	80	125 141 300	A1	6.3		200	200	100	7	AO8	P
	QE06/50	274 130 000 0000	80	254 130 000	A1	6.3	14	200	250	83	6.5	UX5	P
	QL77	802 384 100 0000	00	6*2 364 100		6.3	8.5	250		10.5	2.2	B7G	T
	QN77	412 380 700 0000	00	412 360 500		6.3	12.5	250	250	16	2.6	B7G	P
	QP21	548 237 800 0000	00	446 235 700		2	4.5	150	150	11	2.3	B7	PP
	QP22A	487 230 785 0000	00	465 230 574		2	12	150	150	3	4	B9	PP
	QP22B	458 237 800 0000	00	446 235 700		2	11.7	150	150	3.8		B7	PP
	QP25	208 745 830 0000	00	207 544 630		6.3	2	150	125	10	3	M08	PP
	QP230	548 237 800 0000	00	446 235 700		2	9.6	150	125	4.6	3	B7	PP
	QP240	487 230 785 0000	00	465 230 574		3	5	150	150	25	4	B9	PP
	QQ03/12	801 237 144 0000	00	602 235 144		6.3		300	250	45	7	B9A	P
	QQC03/14	415 238 782 0000	00	412 657 240		3.1		200	200	30	3.2	B9A	PP

SPEC.	VALVE TYPE NUMBER	PIN CONNECTIONS				CHARACTERISTICS						BASE	VALVE CLASS
		VCM163 Tester Only		CT160, VT160, VCM Mk 1,2,3,4		Vh	Vg1	Va	Vg2	la	gm mA/V		
		SELECTOR SWITCH	TOP CAP	SELECTOR SWITCH	TOP CAP	V	V	V	V	mA	†Ra MΩ		
	QQC04/15	283 824 740 0000	00	263 724 540		6.3	14	200	200	20	2	B8B	P
	QQE02-5	415 228 783 0000	00	415 226 573		6.3	5	250	200	25	10.5	B9A	PP
	QQE03-12	514 228 783 0000	00	414 226 573		6.3	15	200	200	30	3.3	B9A	PP
	QQE03/20	257 134 200 0000	88	245 134 200	A1/A2	6.3	17	400	200	20	2.5	B7A	PP
	QQE04-20	247 135 200 0000	88	245 134 200	A1/A2	6.3	26	400	250	30	3	B7A	PP
	QQE06-40	257 134 200 0000	88	245 134 200	A1/A2	6.3		400	250	30	3.4	B7A	PP
	QQV02-6	415 228 783 0000	00	414 226 573		6.3	5	250	200	25	10.5	B9A	PP
	QQV03-10	514 228 783 0000	00	414 226 573		6.3	10	200	150	30	3.3	B9A	PP
	QQV03-20	247 135 200 0000	88	245 134 200	A1/A2	6.3	17	300	200	20	2.5	B7A	PP
	QQV03-25	257 104 300 0000	88	345 124 300	A1/A2	6.3	15	400		40	2.5	B7A	PP
	QQV04-15	257 134 200 0000	88	245 134 200	A1/A2	6.3	27	400	250	30	3	B7A	PP
	QQV04-20	251 731 420 0000	88	241 531 420	A1/A2	6.3	23	400	200	25	4	B7A	PP
	QQV06-40	247 135 200 0000	88	245 134 200	A1/A2	6.3		400	250	30	3.4	B7A	PP
	QQV07-40	247 135 200 0000	88	245 134 200	A1/A2	6.3		300	250	25	1.9	B7A	PP
	QQV07-50	257 104 300 0000	88	345 124 300		6.3		400	250	100	4.5	B7A	PP
	QQV07-50	347 125 300 0000	88	345 124 300	A1/A2	6.3		400	250	100	4.5	B7A	PP
	QQZ03-20	247 105 200 0000	88	245 1*4 200	A1/A2	1.6		300	250	40	4	B7A	PP
	QQZ04-15	283 825 740 0000	00	273 625 540		3	10	300	200	20	2	B8B	PP
	QQZ06-40	257 304 200 0000	88	245 3*4 200	A1/A2	2.1		200	200	30	4.5	B7A	PP
	Q/U37	023 000 000 0000	90	023 000 000	D1	1.4						B3G	D
	Q/U452	230 000 000 0000	90	230 000 000	D1	2						B3G	D
	QU456	230 000 000 0000	90	328 000 000		6.3						B3G	D
	QV03-12	801 237 144 0000	00	602 235 144		6.3	7.5	250	250	45	7	B9A	P
	QV04-7	287 711 413 0000	00	265 511 413		6.3	30	300	250	25	1.9	B9G	P
	QV04-12	801 237 144 0000	00	601 235 144		6.3	7.5	250	250	45	7	B9A	P
	QV04-15	247 135 200 0000	88	245 134 200	A1/A2	6.3	60	400	250	90		B7A	PP
	QV04-20	241 731 520 0000	88	241 531 420	A1/A2	6.3	22	400	200	25	4	AO8	PP
	QV05-25	274 130 000 0000	80	254 130 000	A1	6.3	12.5	300	250	83	6.5	UX5	P
	QV06-20	127 141 310 0000	80	125 141 310	A1	6.3	28	200	200	100	7	AO8	P
	QW77	412 381 700 0000	00	412 361 500		6.3	2.5	200	200	8	2.5	B7G	P
	QZ06-20	237 242 300 0000	80	235 242 300		1.6		200	100	100		AO8	T
	QZ77	412 381 700 0000	00	412 361 500		6.3	2	250	250	10	7.6	B7G	P
	R1	9X2 300 000 0000	00	892 300 000		4				30		B4	RR
	R2	9X2 300 000 0000	00	892 300 000		4				60		B4	RR
	R4B	902 300 000 0000	00	802 300 000		4				60		B4	R
	R10	112 311 100 0000	90	112 311 100	D1	4				5		B7G	R
	R11	002 300 000 0000	90	002 300 000	D1	4				5		B4	R
	R12	023 000 000 0000	90	023 000 000	D1	6.3				0.1		B3G	D
	R13A	029 0X0 310 0000	00	028 090 310		13				30		AO8	RR
	R14	029 1X3 210 0000	00	028 193 210		26				120		AO8	RR
	R16	123 000 000 0000	90	123 000 000	D1	1.4				2		B3G	D
	R17	001 230 000 0000	90	**1 23* ***	D1	6.3				120		B9A	R
	R19	230 232 032 0000	90	230 232 032	D1	1.2						B9A	D
	R20	230 232 032 0000	90	23* 232 *32	D1	2						B9A	R
	R41	9X2 300 000 0000	00	892 300 000		4				60		B4	RR
	R43	9X2 300 000 0000	00	892 300 000		4				180		B4	RR
	R52	030 90X 020 0000	00	030 809 020		5				60		20mA	RR
	R80	284 300 000 0000	00	264 300 000		4	24	250		20	4	UX4	T
	R116	028 740 310 0000	40	026 540 310	G1	10	2.2	200	200	8		AO8	P
	R120	028 040 310 0000	00	026 040 310		6.3		250		60	6.4	AO8	T
	R122N	028 710 310 0000	40	026 510 310	G1	18		200	200	8	5.5	AO8	P

SPEC.	VALVE TYPE NUMBER	PIN CONNECTIONS				CHARACTERISTICS						BASE	VALVE CLASS
		VCM163 Tester Only		CT160, VT160, VCM Mk 1,2,3,4		Vh	Vg1	Va	Vg2	la	gm mA/V		
		SELECTOR SWITCH	TOP CAP	SELECTOR SWITCH	TOP CAP	V	V	V	V	mA	†Ra MΩ		
	R123	028 700 310 0000	40	026 500 310	G1	18		200	200	35	8.5	AO8	P
	R125C	028 9X0 310 0000	40	026 890 310	G1	18	5.5	250		5	2.5	AO8	DDT
	R126F	028 710 310 0000	40	026 510 310	G1	18		200	200	6	1.7	AO8	P
	R128	029 1X0 310 0000	00	028 190 310		18						AO8	DD
	R134	028 741 310 0000	00	026 541 310		18		200	200	18	6	AO8	P
	R142	412 378 010 0000	00	412 356 010		6.3		200	200	10.5	8.5	B8D	P
	R143	412 378 010 0000	00	412 356 010		6.3		200	200	8	5.5	B8D	P
	R144	412 381 700 0000	00	412 361 500		6.3	2	250	250	10	7.6	B7G	P
	R145	412 378 010 0000	00	412 356 010		18		200	200	8	5.5	B8D	P
	R147	412 378 110 0000	00	412 356 110		18		200	200	18	6	B8D	F
	R148	841 238 510 0000	00	641 237 410		18		250		10	5.5	B8D	TT
	R150	123 141 718 0000	00	123 141 516		6.3	1.6	150	150	12.5	16	B9A	P
	R236	028 710 300 0000	40	026 510 300	G1	1.2	2	100	100	1	0.5	AO8	P
	R242P	400 123 080 0000	00	400 123 060		6.3	4.5	150		15	4.3	B5A	T
	R244	402 013 080 0000	00	402 013 060		6.3		150		13		B8D	T
	R265	412 380 710 0000	00	412 360 510		6.3		100	100	7.5	5	B8D	P
	R271	412 183 710 0000	00	412 163 510		6.3	2	150	125	5.2	3.2	B8D	P
	R290	020 090 030 0000	00	020 080 030		1.2				5		AO8	D
	R2018	842 310 000 0000	00	642 310 000		20	2.5	200		2.5	3	B5	T
	R5559	802 101 413 0000	00	6*2 1*1 413		6.3	1.5	150		25	25	B5D	T
	RA	9X2 310 000 0000	00	892 310 000		13				30		B5	RR
	RA1	384 200 000 0000	00	364 200 000		15	4.5	90		4.5	1.2	UX4	T
	RB350/80	9X2 300 000 0000	00	892 300 000		4				30		B4	RR
	R8500/120	9X2 300 000 0000	00	892 300 000		4				60		B4	RR
	RB650/250	9X2 300 000 0000	00	892 300 000		4				120		B4	RR
	RC5B	023 009 080 0000	40	023 008 060	G1	12.6	0	100		24	6	8SC	DT
	RC5C	023 009 080 0000	40	023 008 060	G1	2.4	0	100		24	6	8SC	DT
	RE034	842 300 000 0000	00	642 300 000		4	3	200		2	1.2	B4	T
	RE052	842 300 000 0000	00	642 300 000		2	3	150		1	1	B4	T
	RE054	842 300 000 0000	00	642 300 000		4	4	150		4	1.3	B4	T
	RE062	842 300 000 0000	00	642 300 000		2	9	150		4	1	B4	T
	RE074	842 300 000 0000	00	642 200 000		4	9	150		3.5	0.9	B4	-
	RE074D	842 300 000 0000	00	642 300 000		4	3	150		3.5	0.5	B5	T
	RE074N	842 300 000 0000	00	642 300 000		4	9	150		3.5	0.9	B4	T
	RE076	842 300 000 0000	00	642 300 000		6.3	9	150		4	1.5	B4	T
	RE084	842 300 000 0000	00	642 200 000		4	4	150		4	1.5	B4	T
	RE114	842 300 000 0000	00	642 300 000		4	15	150		13	1.3	B4	T
	RE122	842 300 000 0000	00	264 300 000		2	4.5	150		3	1.3	UX4	T
	RE122	284 300 000 0000	00	642 300 000		2	19	150		7	1.2	B4	T
	RE124	842 300 000 0000	00	642 300 000		4	18	150		11	1.6	B4	T
	RE134	842 300 000 0000	00	642 300 000		4	17	250		12	2	B4	T
	RE144	842 300 000 0000	00	642 300 000		4	9	150		2	0.7	B4	T
	RE304	842 300 000 0000	00	642 300 000		4	32	250		20	1.9	B4	T
	RE402B	084 235 800 0000	00	064 234 700		2	0	150		3		B7	TT
	RE404	842 300 000 0000	00	642 300 000		3.5	125	200			0.6	B4	T
	RE604	842 300 000 0000	00	642 300 000		4	45	250		40	2.5	B4	T
	REL39	402 387 100 0000	00	402 365 100		6.3	2	300	150	10	9	B7G	P
	REN704	872 310 000 0000	40	652 310 000	G1	4		100		2	1.2	B5	P
	REN904	842 310 000 0000	00	642 310 000		4	3.5	200		6	2.4	B5	T
	REN914	842 310 000 0000	00	642 310 000		4	1.5	200		0.2		B5	T

SPEC.	VALVE TYPE NUMBER	PIN CONNECTIONS				CHARACTERISTICS						BASE	VALVE CLASS
		VCM163 Tester Only		CT160, VT160, VCM Mk 1,2,3,4		Vh	Vg1	Va	Vg2	la	gm mA/V		
		SELECTOR SWITCH	TOP CAP	SELECTOR SWITCH	TOP CAP	V	V	V	V	mA	†Ra MΩ		
REN924	842 310 000 0000	90		642 310 000	D1	4	3	200		6	2	B5	DT
REN1004	842 310 000 0000	00		642 310 000		4		200			1.5	B5	T
REN1104	842 310 000 0000	00		642 310 000		4	16	200		12	1.3	B5	T
REN1814	842 310 000 0000	00		642 310 000		20	1.6	200		0.2	1	B5	T
REN1817D	872 310 000 0000	40		652 310 000	G1	20		100	100		1.1	B5	P
REN1821	842 310 000 0000	00		642 310 000		20	3	200		6	2.3	B5	T
REN1822	842 310 000 0000	00		642 310 000		20	18	200		15	1.6	B5	P
REN1826	842 310 000 0000	90		642 310 000	D1	20	3	200		6	1.8	B5	DT
RENS1204	742 310 000 0000	80		542 310 000	A1	4	2	200	60	4	1	B5	P
RENS1214	742 310 000 0000	80		542 310 000	A1	4	2.2	200	100	6	1	B5	P
RENS1224	184 772 300 0000	40		164 552 300	G1	4	1.5	200	125	3	0.6	C7	P
RENS1234	187 472 300 0000	40		165 452 300	G1	4	2	200	75	3	1.8	C7	P
RENS1264	742 310 000 0000	80		542 310 000	A1	4	2	200	100	3	2	B5	P
RENS1264/B1	742 300 000 0000	80		542 300 000	A1	4	2	200	100	3	2	B4	T
RENS1274D	842 310 000 0000	70		642 310 000	G2	4	18	250	250	24	2.5	B5	P
RENS1284	742 310 000 0000	80		542 310 000	A1	4	2	200	100	3	2.5	B5	P
RENS1294	742 310 000 0000	80		542 310 000	A1	4	2	200	100	4.5	2	B5	P
RENS1374D	842 310 000 0000	70		642 310 000	G2	4	18	250	250	24	2.5	B5	P
RENS1384	842 310 000 0000	70		642 310 000	G2	4	22	250	250	36	2.8	B5	P
RENS1818	742 310 000 0000	80		542 310 000	A1	20	2	200	100	3	2	B5	P
RENS1819	742 310 000 0000	80		542 310 000	A1	20		200	60	4	1	B5	P
RENS1823D	842 310 000 0000	70		642 310 000	G2	20	18	200	200	20	1.7	B5	P
RENS1884	742 310 000 0000	80		542 310 000	A1	20	2	200	100	3	2.4	B5	P
RENS1894	742 310 000 0000	80		542 310 000	A1	20	2.2	200	100	4	1.8	B5	P
RES094	742 300 000 0000	80		542 300 000	A1	4	2	200	75	4	7	B5	P
RES105	842 300 000 0000	70		642 300 000	G2	5	15	200	150	12	1.3	B4	P
RES164	842 370 000 0000	00		642 350 000		4	11.5	250	75	12	1.4	B5	P
RES174D	842 300 000 0000	70		642 300 000	G2	4	19	250	150	12	1.3	B4	P
RES212	842 370 000 0000	00		642 350 000		2	4.4	150	125	6	2.2	B5	P
RES364	842 370 000 0000	00		642 350 000		4	2.5	300	200	20	1.7	B5	P
RES374	842 370 000 0000	00		642 350 000		4	42	300	200	20	1.5	B5	P
RES664D	842 370 000 0000	00		642 350 000		4	40	400	200	30	1.9	B5	P
RES964	842 370 000 0000	00		642 350 000		4	15	250	250	36	2.8	B5	P
RFG5	003 200 000 0000	90		003 200 000	D1	6						F8	R
RFP8/14	041 231 700 0000	80		041 231 500	A1	4	20	400	250	35	4	B7	P
RFP8/14	742 310 000 0000	80		542 310 000	A1	4	20	400	250	35	4	B5	P
RG250/1000	002 300 000 0000	90		002 300 000	D1	4				120		B4	R
RG250/3000	290 300 000 0000	00		280 300 000		2.5				120		UX4	R
RGN354	902 300 000 0000	00		802 300 000		4				15		B4	R
RGN504	9X2 300 000 0000	00		892 300 000		4				15		B4	RR
RGN564	902 300 000 0000	00		802 300 000		4				30		B4	RR
RGN1054	902 300 000 0000	00		892 300 000		4				30		B4	RR
RGN1074	9X2 300 000 0000	00		892 300 000		4				60		B4	RR
RGN1304	902 300 000 0000	00		802 300 000		4				60		B4	R
RGN1404	092 300 000 0000	00		082 300 000		4				120		B4	R
RGN1503	9X2 300 000 0000	00		892 300 000		2.5				30		B4	RR
RGN2504	9X2 300 000 0000	00		893 300 000		4				60		B4	RR
RGN4004	9X2 300 000 0000	00		892 300 000		4				120		B4	RR



SPEC.	VALVE TYPE NUMBER	PIN CONNECTIONS				CHARACTERISTICS						BASE	VALVE CLASS
		VCM163 Tester Only		CT160, VT160, VCM Mk 1,2,3,4		Vh	Vg1	Va	Vg2	Ia	gm mA/V		
		SELECTOR SWITCH	TOP CAP	SELECTOR SWITCH	TOP CAP	V	V	V	V	mA	†Ra MΩ		
	RH	081 231 700 0000	40	061 231 500	G1	4	1.7	250	100	7.9	7	B7	P
	RK10	284 300 000 0000	00	264 300 000		7.5	100	350		50		UX4	T
	RK15	284 300 000 0000	00	264 300 000		2.5	33	250		22	2.3	UX4	T
	RK16	284 130 000 0000	00	264 130 000		2.5	28	250		26	2.6	B4	T
	RK19	200 300 000 0000	9X	200 300 000	D1/D2	7.5				120		UX4	RR
	RK21	200 300 000 0000	90	200 300 000	D1	2.5				120		UX4	R
	RK24	384 200 000 0000	00	364 200 000		2	13.5	200		8	1.6	UX4	T
	RK39	274 130 000 0000	80	254 130 000	A1	6.3	14	300	250	83	6.5	UX5	P
	RK60	200 300 000 0000	9X	200 300 000	D1/D2	5				120		UX4	RR
	RL2T2	238 400 000 0000	00	236 400 000		1.9	1.5	100		15	2.4	5AA	T
	RL7	287 114 113 0000	00	265 114 113		6.3	1.7	250	250	10	7.7	B9G	P
	RL12P2	287 114 113 0000	00	265 114 113		12.6	6	150	150	15	2.3	B9G	P
	RL15A	710 423 208 0000	00	510 423 206		2.4	20	350	200	57		B9A	P
	RL16	241 800 003 0000	00	241 600 003		6.3	2.5	250		10	6.5	B9G	T
	RL18	123 000 000 0000	00	123 000 000		6.3	3.3	200		7.5	2.9	B3G	T
	RL37	244 884 413 0000	00	244 664 413		6.3	1.5	250		10	9	B9G	T
	R0337	9X2 300 000 0000	00	892 300 000		2.5				30		B4	RR
	R0481	902 300 000 0000	00	802 300 000		4				120		B4	R
	R0534	9X2 300 000 0000	00	892 300 000		5				60		B4	RR
	R0771	902 300 000 0000	00	802 300 000		7.5				120		B4	R
	RRAF	842 300 000 0000	00	642 300 000		4	2	100		4	1.4	B4	T
	RRBF	842 300 000 0000	00	642 300 000		4	2.5	100		10	1.2	B4	T
	RS	902 310 000 0000	00	802 310 000		3				60		B5	R
	RS242	842 300 000 0000	00	642 300 000		3.8	5	400		70	3	B4	T
	RS1009	247 135 200 0000	88	245 134 200	A1/A2	6.3	25	400	250	30	3.4	B7A	PP
	RS1019	247 235 200 0000	88	245 134 200	A1/A2	6.3	20	400	250	20	2.5	B7A	PP
	RSAF	742 300 000 0000	80	542 300 000	A1	4	1	150	75	4.5	1.2	B4	T
	RT1-2	842 300 000 0000	00	642 300 000		4	2.6	150		26	2.5	B4	T
	RT2	842 300 000 0000	00	642 300 000		4	4	200		18	1.7	B4	T
	RT3	842 300 000 0000	00	642 300 000		4	2.3	300		15	2.8	B4	T
	RTR4141	028 710 310 0000	40	026 510 310	G1	5.2	3	250	100	2.5	1.2	AO8	P
	RTR4142	028 710 310 0000	40	026 510 310	G1	5.2	8	250	125	15	2.7	AO8	P
	RTR4341	081 231 700 0000	40	061 231 500	G1	21	2.2	150	8	8	8	B4	P
	RTR4342	007 231 800 0000	40	005 231 600	G1	21	5.8	150	125	48	9	B7	P
	RV12P2000	470 812 310 0000	00	450 612 310		12.6	2.3	200	75	1.8	1.5	B7	P
	RV120/250	9X2 300 000 0000	00	892 300 000		12.6	2.3	200	75	1.8	1.5	B7	P
	RV120/350S	023 090 0X0 0000	00	023 080 090		4				60		8SC	RR
	RV120/500S	023 090 0X0 0000	00	023 080 090		4				60		8SC	RR
	RV200/600	9X2 300 000 0000	00	892 300 000		4				120		B4	RR
	RV210	042 310 000 0000	80	042 310 000	A1	4	53	400		70	5.8	B5	T
	RX21	200 030 000 0000	90	200 030 000	D1	2.5				120		UX5	R
	RX215	39X 200 000 0000	00	389 200 000		2.5				5		UX4	RR
	RZ	023 100 090 0000	00	023 100 080		20				60		8SC	R
	S2	742 300 000 0000	80	542 300 000	A1	2	1	150	60	2.3	1.1	B4	P
	S2P20	801 227 413 0000	00	601 225 413		5	10	150	150	28	4.4	B9A	P
	S4V	742 310 000 0000	80	542 310 000	A1	4	1	200	75	1.5	1.1	B5	P
	S4VA	742 310 000 0000	80	542 310 000	A1	4	1.5	200	100	2.8	2	B5	P
	S4VB	742 310 000 0000	80	542 310 000	A1	4	1.5	200	125	4.6	2.5	B5	P
	S6F12	412 381 700 0000	00	412 361 500		6.3	2	250	250	10	7.5	B7G	P

SPEC.	VALVE TYPE NUMBER	PIN CONNECTIONS				CHARACTERISTICS						BASE	VALVE CLASS
		VCM163 Tester Only		CT160, VT160, VCM Mk 1,2,3,4		Vh	Vg1	Va	Vg2	Ia	gm mA/V		
		SELECTOR SWITCH	TOP CAP	SELECTOR SWITCH	TOP CAP	V	V	V	V	mA	†Ra MΩ		
S6F17	412 381 700 0000	00		412 361 500		6.3	5	100	100	12.5	4	B7G	P
S6F17F	412 381 700 0000	00		412 361 500		6.3		200	200	17	4	B7G/F	P
S6F33	412 381 700 0000	00		412 361 500		6.3	3.3	200	200	7.1	4	B7G	P
S11E12	028 741 310 0000	00		*26 541 310		6.3	8.5	150	150	200	13.5	AO8	P
S12	742 300 000 0000	80		542 300 000	A1	2	1	100	30	2.5	0.7	SM4	P
S19G6	012 300 000 0000	90		*12 3** *00	D1	4				30		B7G	R
S21	742 300 000 0000	80		542 300 000	A1	2	1.5	150	75	2	1.1	B4	P
S22	742 300 000 0000	80		542 300 000	A1	2	1.5	150	75	1.5	1.7	B4	P
S23	742 300 000 0000	80		542 300 000	A1	2	1.5	150	75	2.8	1.1	B4	P
S24	742 300 000 0000	80		542 300 000	A1	2	1	150	75	3.2	1.4	B4	P
S30C	842 300 000 0000	00		642 300 000		4	38	300		50	5	B4	T
S30D	842 300 000 0000	00		642 300 000		2	38	300		50	5	B4	T
S207	742 300 000 0000	80		542 300 000	A1	2	1.5	200	100	3	0.7	B4	P
S208	542 300 000 0000	80		542 300 000	A1	2		200	100	2	0.8	B4	P
S209	023 010 780 0000	40		023 010 560	G1	2	0.5	150	125	2.4	0.7	8SC	P
S210	842 300 000 0000	70		642 300 000	G2	2	1.5	150	90	3	1.2	B4	P
S213	742 300 000 0000	80		542 300 000	A1	2	0.5	150	90	3	1.3	B4	P
S215	742 300 000 0000	80		542 300 000	A1	1	1	150	90		0.9	B4	P
S215A	742 300 000 0000	80		542 300 000	A1	2	1	150	60	2	1.1	B4	P
S215B	742 300 000 0000	80		542 300 000	A1	2	1	150	60	1.5	1.2	B4	P
S215VM	742 300 000 0000	80		542 300 000	A1	2	1.4	150	60	1	0.8	B4	P
S217	742 300 000 0000	80		041 230 500	A1	2	0.5	150	150	2.5	1.7	B7	P
S217	041 230 700 0000	80		542 300 000	A1	2	0.5	150	150	2.3	1.7	B4	P
S218	041 230 700 0000	80		041 230 500	A1	2	0.5	150	150	3	1.9	B7	P
S220	742 300 000 0000	80		542 300 000	A1	2		150	75	4	1.1	B4	P
S310A	287 113 000 0000	40		265 113 000	G1	10	3	150	150	5.5	1.9	UX6	P
S311A	287 130 000 0000	40		265 130 000	G1	10	15	150	150	30	2.8	UX5	P
S328A	287 113 000 0000	40		265 113 000	G1	7.5	3	150	150	5.5	1.9	UX6	P
S329A	287 130 000 0000	40		265 130 000	G1	7.5	15	150	150	30	2.8	UX5	P
S329L	287 113 000 0000	40		265 113 000	G1	7.5	50	150	125	30	2.8	UX6	P
S406/7	742 300 000 0000	80		542 300 000	A1	4	2	200	150	1.5	1	B4	P
S408	742 300 000 0000	80		542 300 000	A1	4	1.5	200	75	4	0.7	B4	P
S409	742 300 000 0000	80		542 300 000	A1	4	1.5	200	75	4	8.8	B4	P
S410	742 300 000 0000	80		542 300 000	A1	4	1.5	200	75	4	1	B4	P
S410N	742 310 000 0000	80		542 310 000	A1	4	2	200	60	4	1	B5	P
S412N	742 310 000 0000	80		542 310 000	A1	4	1.3	200	100	1.5	1	B5	P
S415N	742 310 000 0000	80		542 310 000	A1	4	2	200	100	6	1	B5	P
S420	081 231 700 0000	40		061 231 500	G1	4	3	250	250	11.5		B7	P
S423	023 110 780 0000	40		023 110 560	G1	4	3	250	100	8	1.8	8SC	P
S424	023 110 780 0000	40		023 110 560	G1	4	2	250	100	3	2.1	8SC	P
S430N	742 310 000 0000	80		542 310 000	A1	4	1.3	200	100	1.5	0.9	B5	P
S431N	742 310 000 0000	80		542 310 000	A1	4	1.5	250	100	3	2	B5	P
S432N	023 110 780 0000	40		023 110 560	G1	4	3	250	100	2.5	2.2	8SC	P
S434N	742 310 000 0000	80		542 310 000	A1	4	2	200	100	4.5	2.3	B5	P
S434N	041 231 700 0000	80		041 231 500	A1	4	1.5	200	100	4.5	2	B7	P
S435N	742 310 000 0000	80		041 231 500	A1	4	2	200	100	3	2.3	B7	P
S435N	041 231 700 0000	80		542 310 000	A1	4	2	200	100	3	2.3	B5	P
S440	081 231 700 0000	40		061 231 500	G1	4	2.4	250	250	4.1	3.5	B7	P
S493	742 310 000 0000	80		542 310 000	A1	4	2	200	100	4		B5	P
S495	742 310 000 0000	80		542 310 000	A1	4	2	200	100	6	2.5	B4	P

SPEC.	VALVE TYPE NUMBER	PIN CONNECTIONS				CHARACTERISTICS						BASE	VALVE CLASS
		VCM163 Tester Only		CT160, VT160, VCM Mk 1,2,3,4		Vh	Vg1	Va	Vg2	la	gm mA/V		
		SELECTOR SWITCH	TOP CAP	SELECTOR SWITCH	TOP CAP	V	V	V	V	mA	†Ra MΩ		
S617	023 110 780 0000	40		023 110 560	G1	6.3	3	250	100	2.5	2.2	8SC	P
S620	023 110 780 0000	40		023 110 560	G1	6.3	2.5	250	100	3.5	2	8SC	P
S1323	023 110 780 0000	40		061 231 500	G1	13	3	200	100	8	1.9	B7	P
S1323	081 231 700 0000	40		023 110 560	G1	13	3	200	100	8	1.9	8SC	P
SI324	081 231 700 0000	40		061 231 500	G1	13	2	200	100	3	2.4	B7	P
S1327	023 110 780 0000	40		023 110 560	G1	13	2.5	250	100	3.5	2	8SC	P
S1328	023 110 780 0000	40		023 110 560	G1	13	2	200	100	3	2.4	8SC	P
S2010N	742 310 000 0000	80		542 310 000	A1	20	2	200	60	4	1	B5	P
S2108	041 231 700 0000	80		041 231 500	A1	20	3	200	60	4	1.2	B7	P
S2108	742 310 000 0000	80		542 310 000	A1	20	3	200	60	4	1.2	B5	P
S2030N	742 310 000 0000	80		542 310 000	A1	20	2	200	100	3	2	B5	P
S2035N	742 310 000 0000	80		542 310 000	A1	20	2.5	250	100	3.5	2	B5	P
S2043	742 310 000 0000	80		542 310 000	A1	20	2.5	250	100	5	2	B5	P
S2020A	274 300 000 0000	00		254 300 000		2	1	150		1.3	0.6	UX4	T
S2020B	842 300 000 0000	00		642 300 000		2	1	150		1.3	0.6	UX4	T
S4021A	284 300 000 0000	00		264 300 000		4	8	150		20	3	UX4	T
S4021B	842 300 000 0000	00		642 300 000		4	8	150		20	3	B4	T
S4022AR	238 400 000 0000	00		236 400 000		4	4.5	150		5	2.2	UX4	T
S4022B	842 300 000 0000	00		642 300 000		4	4.5	150		5	2.2	B4	T
S4045A	842 370 000 0000	00		642 350 000		5	70	250	75	45	1.5	B5	P
SD	9X2 310 000 0000	00		892 310 000		5						B5	DD
SD2	842 300 000 0000	00		642 300 000		2	1.5	150		2.2	1.4	B4	T
SD6	092 310 000 0000	00		*82 310 *00		6.3				5		B7G	R
SD61	213 000 000 0000	90		123 000 000	D1	6.3				5		B3G	D
SD917	402 013 080 0000	00		402 013 060		6.3	3.6	100		1.4	2.7	B8A	T
SD917A	402 013 090 0000	00		402 013 080		6.3	4.7	100		1.4	2.7	B8A	T
SE211	742 300 000 0000	80		542 300 000	A1	2	1	150	75	1	1.5	B4	P
SE2018	742 310 000 0000	80		542 310 000	A1	20	3	200	60	4	1.2	B5	P
SE2118	742 310 000 0000	80		542 310 000	A1	20	24	200	100	3	3	B5	P
SG2	742 300 000 0000	80		542 300 000	A1	2		150	75	2.5	1	B4	P
SG215	742 300 000 0000	80		542 300 000	A1	2	1.5	150	75	2.7	1	B4	P
SG215VM	742 300 000 0000	80		542 300 000	A1	2	1.5	150	75		1.5	B4	P
SG220SW	872 300 000 0000	40		652 300 000	G1	2	1.5	150	75	2.4	1.5	B4	P
SG2150	742 300 000 0000	80		542 300 000	A1	2	1.5	150	75	1.5	1.1	B4	P
SGA1	742 310 000 0000	80		542 310 000	A1	4		200	100	6	3	B5	P
SN1016	412 183 710 0000	00		412 163 510		6.3	1.5	100	100	7.5	5	B8D	P
SN954	092 913 090 0000	00		082 813 080		6.3				30		B8A	R
SN956B	023 990 000 0000	00		023 880 000		1.2						B3G	D
SN1007	412 183 710 0000	00		412 163 510		6.3	0.8	100	100	5.3	3.2	B8A	P
SN1038A	412 183 710 0000	00		412 163 510		6.3	1.4	100	100	7	5	B8D	P
SN1039	412 387 100 0000	00		412 365 100		6.3	2	120	120	7.5	5	B7G	P
SN1039A	412 387 100 0000	00		412 365 100		6.3	1.4	100	100	7	5.1	B7G	P
S01	284 300 000 0000	00		264 300 000		15	40.5	200		21	1.5	UX4	T
S02	284 300 000 0000	00		264 300 000		7.4	88	400		55	2.1	UX4	T
S0401	002 300 000 0000	84		002 300 000	A	4		400			2	B4	T
SP2	041 230 700 0000	80		041 230 500	A1	2		150	150	3	1.8	B7	P
SP2B	081 230 700 0000	40		061 230 500	G1	2	1	150	150	2.6	0.8	8SC	P
SP2BS	032 004 780 0000	00		032 004 560		2	0.5	150	150	2.6	0.8	8SC	P
SP2D	081 230 700 0000	40		061 230 500	G1	2	1	150	150	1.4	1.7	B7	P
SP2D	742 300 000 0000	80		542 300 000	A1	2	1	150	125	1.5	1.7	B4	P
SP2V	041 230 700 0000	80		041 230 500	A1	2		150	75	2.9	1.1	B7	P

SPEC.	VALVE TYPE NUMBER	PIN CONNECTIONS				CHARACTERISTICS						BASE	VALVE CLASS
		VCM163 Tester Only		CT160, VT160, VCM Mk 1,2,3,4		Vh	Vg1	Va	Vg2	la	gm mA/V		
		SELECTOR SWITCH	TOP CAP	SELECTOR SWITCH	TOP CAP	V	V	V	V	mA	†Ra MΩ		
	SP4(TUNG)	081 231 700 0000	40	061 231 500	G1	4	2	200	100	3	2.3	B7	P
	SP4(MUL)	041 231 700 0000	80	041 231 500	A1	4	2	200	100	3	2.3	B7	P
	SP4	742 310 000 0000	80	542 310 000	A1	4	2	200	100	3	2.3	B5	P
	SP4A	041 231 700 0000	80	041 231 500	A1	4	2	250	100	3	2.4	B7	P
	SP4B	081 231 700 0000	40	061 231 500	G1	4	2.4	250	250	4	3.4	B7	P
	SP4C	023 110 780 0000	40	023 110 560	G1	4	2.4	250	250	4	3.4	8SC	P
	SP4S	023 110 780 0000	40	023 110 560	G1	4	2	250	100	3	2.5	8SC	P
	SP6	412 381 700 0000	00	412 361 500		6.3	2	250	250	10	7.5	B7G	P
	SP6	412 381 700 0000	00	412 361 500		6.3	1.4	200	150	4	6.4	B7G	P
	SP6S	023 110 780 0000	40	023 110 560	G1	6.3	2	250	100	3	2	8SC	P
	SP13	081 231 700 0000	80	061 231 500	A1	13	2	200	100	3.3	2.2	B7	P
	SP13	023 110 780 0000	40	023 110 560	G1	13	2	200	100	3.3	2.2	8SC	P
	SP13C	081 231 700 0000	40	061 231 500	G1	13	2.2	200	200	2.5	2.8	B7	P
	SP13S	023 110 780 0000	40	023 110 560	G1	13	2	150	100	3	2.4	8SC	P
	SP20	742 310 000 0000	80	542 310 000	A1	20		200	100	4.5	3.5	B5	P
	SP22	208 710 030 0000	40	206 510 030	G1	2	1	150	125	1.1	1.2	M08	P
	SP35	023 110 780 0000	40	023 110 560	G1	35	8	200	200	41	7	8SC	P
	SP41	218 710 030 0000	40	216 510 030	G1	4	1.5	200	200	10.9	8.5	M08	P
	SP42	218 710 030 0000	40	216 510 030	G1	4	1.3	200	125	20	8.4	M08	P
	SP61	218 710 030 0000	40	216 510 030	G1	6.3	1.5	200	200	10.9	8.5	M08	P
	SP62	218 710 030 0000	40	216 510 030	G1	6.3	1.3	200	100	16	9	M08	P
	SP65	023 110 780 0000	40	023 110 560	G1	6.3	2	250	100	3	2.1	8SC	P
	SP141	208 700 030 0000	40	206 500 030	G1	1.4	1	90	90	1.3	0.8	M07	P
	SP181	218 710 030 0000	40	216 510 030	G1	18	1.5	200	200	10.9	8.5	M08	P
	SP210	041 230 700 0000	80	041 230 500	A1	2	1	125	125	1.1	1.2	B7	P
	SP215	041 230 700 0000	80	041 230 500	A1	2	1.5	150	80	2.1	1.6	B7	P
	SP220	842 300 000 0000	00	642 300 000		2	12	150		14	3	B4	T
	SP514	401 108 073 0000	00	402 106 053		6.3	1.7	150	150	12.3	13.5	B9A	P
	SP804E	211 043 000 0000	80	211 043 000	A	6.3	15	400	40	4		UX6	T
	SP804F	211 043 000 0000	84	211 043 000	A	6.3	15	400		40	4	UX6	T
	SP1320	041 231 700 0000	80	041 231 500	A1	13	1.5	150	100	4.4	2	B7	P
	SP2220	041 231 700 0000	80	041 231 500	A1	22	3	250	200	4.9	2.7	B7	P
	SPT2	041 230 700 0000	80	041 230 500	A1	2	1	125	125	2.8	1.5	B7	P
	SPT4A	041 231 700 0000	80	041 231 500	A1	4	1.5	250	100	2	2.3	B7	P
	SPTA	081 231 400 0000	40	061 231 400	G1	13	2.5	200	100	2.2	1.4	B7	P
	SPTA	041 231 700 0000	80	041 231 500	A1	13	2.5	250	100	2.2	1.4	B7	T
	SPTS	041 231 700 0000	80	041 231 500	A1	13	1.5	250	100	2	3	B7	P
	SR2	842 300 000 0000	00	642 300 000		2	16	200		10	3	B4	T
	SR4	842 310 000 0000	00	642 310 000		4	20	250		20	4	B5	T
	SRS4451	247 135 200 0000	88	245 134 200	A1/A2	6.3	25	400	250	30	3.4	B7A	PP
	SS210C	742 300 000 0000	80	542 300 000	A	2	1	150	175	0.6	1.4	B4	P
	SS210D	842 300 000 0000	00	642 300 000		2	4.5	150		2	1.6	B4	T
	SS210DDT	892 3X0 000 0000	40	682 390 000	G1	2	5.5	150		2.4	1.4	B5	DDT
	SS210HF	842 300 000 0000	00	642 300 000		2	4	150		1	0.8	B4	T
	SS210HL	842 300 000 0000	00	642 300 000		2	1.5	150		21.4	12.5	B4	T
	SS220P	842 300 000 0000	00	642 300 000		2	12	150		6	1.5	B4	T
	SS220PA	842 300 000 0000	00	642 300 000		2	6	150		8	3.5	B4	T
	SS220SP	842 300 000 0000	00	642 300 000		2	12	150		14	3.5	B4	T
	SS2018	742 310 000 0000	80	542 310 000	A1	20	3	200	100	3	3	B5	P
	ST507	802 441 443 0000	00	602 441 443		6.3	1.2	150		23	25	B9A	T

SPEC.	VALVE TYPE NUMBER	PIN CONNECTIONS				CHARACTERISTICS						BASE	VALVE CLASS	
		VCM163 Tester Only		CT160, VT160, VCM Mk 1,2,3,4		Vh	Vg1	Va	Vg2	la	gm mA/V			
		SELECTOR SWITCH	TOP CAP	SELECTOR SWITCH	TOP CAP	V	V	V	V	mA	†Ra MΩ			
	SU25	020 000 300 0000	90	*2* 0** 3*0	D1	2							AO8	D
	SU42	030 000 020 0000	90	030 000 020	D1	4							AO8	R
	SU45	112 311 100 0000	90	112 311 100	D1	4				30			B7G	R
	SU61	023 000 000 0000	90	023 000 000	D1	6.3				0.35			B3G	D
	SU3130	002 300 000 0000	90	002 300 000	D1	2							B4	D
	SW1	902 300 000 0000	00	802 300 000		4				30			B4	R
	SWG2	872 300 000 0000	40	652 300 000	G1	2		150	75		1.5		B4	P
	T2	842 300 000 0000	00	642 300 000		2	1	100			1		B4	T
	T2M05	882 345 100 0000	00	672 344 100		6.3	0	100		8.5	5.3		B7G	TT
	T2M05	882 345 100 0000	00	672 344 100		6.3	3	150		5	4.5		B7G	TT
	T4D	123 000 000 0000	90	123 000 000	D1	4				5			B3G	D
	T5D	123 000 000 0000	90	123 000 000	D1	6.3				5			B3G	D
	T6D	213 000 000 0000	90	213 000 000	D1	6.3				5			B3G	R
	T13U	023 100 080 0000	40	023 100 060	G1	13	4	200		5.9	2.6		8SC	T
	T41	218 040 030 0000	00	216 040 030		4		100		30	2k		M08	THY
	T113	842 300 000 0000	70	642 300 000	G2	3	3	12	12	0.2	0.2		B4	P
	T116	842 300 000 0000	70	642 300 000	G2	1.2	3	12	12	0.2	0.2		-	-
	T134	742 300 000 0000	80	542 300 000	A1	4	1	150	75				-	-
	T136	842 300 000 0000	00	642 300 000		4	8	200		6	1.6		B4	T
	T151	842 300 000 0000	70	642 300 000	G2	4	15	200	150	12	1.8		B4	P
	T204	023 004 080 0000	00	023 004 060		2	1	150		1.8	0.6		8SC	T
	T223	023 004 080 0000	00	023 004 060		2	2	125		3	2.5		8SC	T
	T435	023 100 080 0000	40	023 100 060	G1	4	5	250		6	2.5		8SC	T
	T460	023 004 080 0000	00	023 004 060		4	45	250		60	6		8SC	T
	T635	023 100 080 0000	40	023 100 060	G1	6.3	16	250		20	2.2		8SC	T
	T1335	023 100 080 0000	40	023 100 060	G1	13	4.5	225		6	2.5		8SC	T
	TB13	902 310 000 0000	00	802 310 000		13							B5	D
	TB032	842 300 000 0000	00	642 300 000		2	30	150		12	1.5		B4	T
	TB052	842 300 000 0000	00	642 300 000		2	15	150		7	1.2		B4	T
	TB062	842 300 000 0000	00	642 300 000		2	10.5	150		13	2		B4	T
	TB102	842 300 000 0000	00	642 300 000		2	4	150		5	1.3		B4	T
	TB122	842 300 000 0000	00	642 300 000		2	4.5	150		6	3.5		B4	T
	TB172	842 300 000 0000	00	642 300 000		2	4.5	150		4	1.4		B4	T
	TB282	842 300 000 0000	00	642 300 000		2	1.5	150		2	1.3		B4	T
	TB402	548 230 800 0000	00	446 230 700		4		150		6			B7	TT
	TB452	742 300 000 0000	80	542 300 000	A1	2		150	75	2	1.5		B4	P
	TB552	742 300 000 0000	80	542 300 000	A1	2		150	75	4	1.5		B4	P
	TB622	742 300 000 0000	80	542 300 000	A1	2		150	90	2	1.4		B4	P
	TB9920	842 310 000 0000	00	642 310 000		20	1.5	200		0.2	4		B5	T
	TBC14	90X 231 800 0000	40	809 231 600	G1	4	7	250		4	2		B7	DDT
	TBC113	90X 231 800 0000	40	809 231 600	G1	13	5	200		4	3.6		B7	DDT
	TC05-25	842 300 000 0000	00	642 300 000		4		400		65	2.2		B4	T
	TC432	842 370 000 0000	00	642 350 000		2	4.5	150	150	9.5	2.5		B5	P
	TC432	842 300 000 0000	70	642 300 000	G2	2	4.5	150	150	9.5	2.5		B4	P
	TD05-12	021 010 310 0000	84	*21 010 310	A1/G1	6.3		150		10	4		AO8	T
	TD044	842 300 000 0000	00	642 300 000		4	40	250		40	3		B4	T
	TD2	842 300 000 0000	00	642 300 000		2	7	150		4	0.9		B4	T
	TDD1C	023 19X 080 0000	00	023 189 060		13	5	200		4	2		B7	DDT
	TDD13	023 19X 080 0000	40	023 189 060	G1	13	1	100			2.9		8SC	DDT
	TDD25	90X 231 800 0000	40	809 231 600	G1	25	1	100		4	2		B7	DDT

SPEC.	VALVE TYPE NUMBER	PIN CONNECTIONS				CHARACTERISTICS						BASE	VALVE CLASS
		VCM163 Tester Only		CT160, VT160, VCM Mk 1,2,3,4		Vh	Vg1	Va	Vg2	la	gm mA/V		
		SELECTOR SWITCH	TOP CAP	SELECTOR SWITCH	TOP CAP	V	V	V	V	mA	†Ra MΩ		
	TE2	029 0X0 310 0000	00	028 090 310		26				30		AO8	RR
	TE3	029 0X0 310 0000	00	028 090 310		12				30		AO8	RR
	TE5	029 0X0 310 0000	00	028 090 310		6.3				30		AO8	RR
	TE094	842 310 000 0000	00	642 310 000		4	16	200		12	1.3	B5	T
	TE104	842 300 000 0000	00	642 300 000		4	26	400		61	4	B4	T
	TE244	842 310 000 0000	00	642 310 000		4	3.5	200		6	2.4	B5	T
	TE384	842 310 000 0000	00	642 310 000		4	2	200		3	1.5	B5	T
	TE424	742 310 000 0000	80	542 310 000	A1	4		200	100	3	2	B5	P
	TE434	842 370 000 0000	00	642 350 000		4	14	250	250	36		B5	P
	TE464	041 231 700 0000	80	041 231 500	A1	4		200	100	3	2.5	B7	P
	TE474	041 231 700 0000	80	041 231 500	A1	4	1.5	200	100	4.5	2	B7	P
	TE534	842 310 000 0000	70	642 310 000	G2	4	15	250	250	24		B5	P
	TE564	041 231 700 0000	80	041 231 500	A1	4	1.5	200	100	4.5	2.2	B7	P
	TE634	047 231 800 0000	00	045 231 600		4	22	250	250	36		B7	P
	TE994	842 310 000 0000	00	642 310 000		4	1.6	250		4	4	B5	T
	TF64	081 231 700 0000	40	061 231 500	G1	4	2.7	250	250	11	2	B7	P
	TF104	842 300 000 0000	00	642 300 000		4	36	400		61	4	B4	T
	TH1	288 475 131 0000	00	276 454 300		6.3		100		4		B8B	TH
	TH1	288 475 131 0000	00	276 454 300		6.3	4	250	150	4		B8B	TH
	TH4	847 231 800 0000	50	645 231 700	G1	4	2	150		6	1.2	B7	TH
	TH4	057 231 800 0000	50	645 231 700	G1	4	2	200	100	3.5		B7	TH
	TH13C	847 231 800 0000	50	645 231 700	G1	13	2	150		6	1.2	B7	TH
	TH13C	057 231 800 0000	50	645 231 700	G1	13	1.5	250	75	4.0	1.8	B7	TH
	TH21C	847 231 800 0000	50	645 231 700	G1	21	2	150		6	1.2	B7	TH
	TH21C	057 231 800 0000	50	645 231 700	G1	21	1.5	250	75	4	1.8	B7	TH
	TH22C	847 231 800 0000	50	645 231 700	G1	29		150		5	6	B7	TH
	TH22C	057 231 800 0000	50	645 231 700	G1	29	2	250	100	3.5		B7	TH
	TH29	847 231 800 0000	50	645 231 700	G1	29	2	100		12.0	4.5	B7	TH
	TH29	057 231 800 0000	50	645 231 700	G1	29	2	250	100	3.5		B7	TH
	TH30	847 231 800 0000	50	645 231 700	G1	30		100		9.5	5.5	B7	TH
	TH30	057 231 800 0000	50	645 231 700	G1	30	2	150				B7	TH
	TH30C	847 231 800 0000	50	645 231 700	G1	29		250	100	3.5		B7	TH
	TH30C	057 231 800 0000	50	645 231 700	G1	29	2.5	250	100	3.25		B7	TH
	TH31	218 840 730 0000	50	217 740 530	G1	4	3	100		10.2	4	M08	TH
	TH31	218 050 730 0000	50	217 740 530	G1	4	3	250	100	3	3	M08	TH
	TH41	218 840 730 0000	50	217 640 530	G1	4	3	100		10.2	4	M08	TH
	TH41	218 050 730 0000	50	217 640 530	G1	4	3	250	100	3	3.1	M08	TH
	TH62	028 748 310 0000	50	027 546 310	G1	6.3	2	100		4.4	2.4	AO8	TH
	TH62	028 750 310 0000	50	027 546 310	G1	6.3	2	250	100	3		AO8	TH
	TH232	847 231 800 0000	00	645 231 700		23		75		4.5		B7	TH
	TH232	057 231 800 0000	00	645 231 700		23	3	150	100	3		B7	TH
	TH233	218 840 730 0000	50	217 640 530	G1	23	2	100		14	2.1	M08	TH
	TH233	218 050 730 0000	50	217 640 530	G1	23	2	150	100	2.6	3	M08	TH
	TH401	184 872 300 0000	50	174 652 300	G1	4	2	150		11	2	C7	TH
	TH401	184 872 300 0000	50	174 652 300	G1	4	2	75	75	2.5		C7	TH
	TH2320	847 231 800 0000	50	645 231 700	G1	23		100		4.5	5.3	B7	TH
	TH2320	057 231 800 0000	50	645 231 700	G1	23	3	150	100	3		B7	TH
	TH2321	847 231 800 0000	50	645 231 700	G1	23		100		4	5.2	B7	TH
	TH2321	057 231 800 0000	50	645 231 700	G1	23	2	150	100	2.6	3	B7	TH
	TH2620	847 231 800 0000	50	645 231 700	G1	26	1	100			5.3	B7	TH
	TH2620	057 231 800 0000	50	645 231 700	G1	26	1	250	100		3.9	B7	TH
	TK406	023 104 780 0000	00	023 104 560		4	5	250	250	0.1	†2.0	8SC	TI
∅	TM05	882 345 100 0000	00	672 344 100		6.3	0.8	100		8.5	5.3	B7G	TT
∅	TM05	882 345 100 0000	00	672 344 100		6.3	3	150		5	4.5	B7G	TT

SPEC.	VALVE TYPE NUMBER	PIN CONNECTIONS				CHARACTERISTICS						BASE	VALVE CLASS
		VCM163 Tester Only		CT160, VT160, VCM Mk 1,2,3,4		Vh	Vg1	Va	Vg2	la	gm mA/V		
		SELECTOR SWITCH	TOP CAP	SELECTOR SWITCH	TOP CAP	V	V	V	V	mA	†Ra MΩ		
	TM12	412 344 800 0000	00	412 344 600		6.3		150		15	12	B7G	T
	TP4	781 231 840 0000	50	571 231 640	G1	4	3	150		1.5	1.4	B9	TP
	TP4	781 231 840 0000	50	571 231 640	G1	4	5	250	200	5.5	1.6	B9	TP
	TP22	781 230 840 0000	50	571 230 640	G1	2	1	100		0.8	1.2	B9	TP
	TP22	781 230 840 0000	50	571 230 640	G1	2	1	150	60	1.2	1	B9	TP
	TP23	841 230 800 0000	50	645 230 700	G1	2	1	100		4.5	2.1	B7	TP
	TP23	051 230 800 0000	50	645 230 700	G1	2	1.5	150	60	1	1	B7	TP
	TP25	208 840 730 0000	50	207 640 530	G1	2	1	100		3.7	1.5	M08	TP
	TP25	208 050 730 0000	50	207 640 530	G1	2	1.5	150	60	1	1	M08	TP
	TP26	208 840 730 0000	50	207 640 530	G1	2	1	150		2.2	1.5	M08	TP
	TP26	208 840 730 0000	50	207 640 530	G1	2	1	150	75	1.5	15	M08	TP
	TP230	781 230 840 0000	50	561 230 740	G1	2		100		20	1.1	B9	TP
	TP230	781 230 840 0000	50	561 230 740	G1	2		150	75	4.3	1.3	B9	TP
	TP443	842 370 000 0000	00	642 350 000		4	22	250	250	36	5	B5	P
	TP1340	781 231 840 0000	50	571 231 640	G1	13		200		2	1.4	B9	TP
	TP1340	781 231 840 0000	50	571 231 640	G1	13	6	250	250	6.5	2.1	B9	TP
	TP2620	081 231 840 0000	50	571 231 640	G1	26	2.5	250		1.5	1.4	B9	TP
	TP2620	081 231 840 0000	50	571 231 640	G1	26	4	250	200	6.5	3.4	B9	TP
	TS49	281 704 130 0000	00	261 504 130		20	4.5	250	150	15	6	B8B	P
	TS51	412 387 100 0000	00	412 365 100		6.3	2.3	150	150	7	4.3	B7G	P
∅	TS52	882 345 100 0000	00	672 344 100		6.3	0.8	100		8.5	5.3	B7G	TT
∅	TS52	882 345 100 0000	00	672 344 100		6.3	3	150		5	4.5	B7G	TT
	TS53	741 238 001 0000	00	541 236 **1		18	1.8	200	100	15	10	B9A	P
	TS54	741 238 001 0000	00	541 236 **1		6.3	1.7	200	125	10	9	B9A	P
	TSE4	081 231 700 0000	40	061 231 500	G1	4	2.5	250	150	8	14.5	B7	P
	TSP4	081 231 700 0000	40	061 231 500	G1	4	2.5	200	200	8	4.7	B7	P
	TT2	222 933 3X0 0000	00	222 833 390		4.4						AO8	DD
	TT4	842 310 000 0000	00	642 310 000		4	16	250		20	3.2	B5	T
	TT4A	842 310 000 0000	00	642 310 000		4	9	250		20	4.1	B5	T
	TT11	020 470 310 0000	80	020 450 310	A1	6.3	11	250	150	30	3.5	AO8	P
	TT12	204 731 102 0000	80	204 531 102	A1	19	13	250	250	72	6	B9G	P
	TT14	204 071 103 0000	80	204 051 103	A1	6.3	13	250	250	72	6	B9G	P
	TT15	241 878 153 0000	00	241 657 143		6.3	14	250	150	30	3.9	B9G	PP
	TT19	241 878 153 0000	00	241 657 143		19	16.5	250	150	30	3.9	B9G	PP
	TT20	247 135 200 0000	88	245 134 200	A1/A2	6.3	17	400	200	20	2.5	B7A	PP
	TT21	020 740 310 0000	80	020 540 310	A1	6.3	30	300	300	80	7	AO8	P
	TT22	020 740 310 0000	80	020 540 310	A1	12.6	30	300	300	80	7	AO8	P
	TT23	415 228 783 0000	00	414 226 573		6.3		150	150	25	10.5	B9A	PP
	TT24	514 228 783 0000	00	414 226 573		6.3		250	200	30	3.3	B9A	PP
	TT25	247 818 352 0000	88	245 617 342	A1/A2	6.3		400	250	30	3.4	B7A	PP
	TT210	023 085 480 0000	00	023 074 460		2		150		1.5		8SC	TT
	TV4	023 140 780 0000	00	023 104 560		4	21	250	250	0.2	†1.0	8SC	TI
	TV6	023 104 780 0000	00	023 104 560		6.3	5	250	250	0.09	†2.0	8SC	TI
	TV03-10	452 310 000 0000	88	442 310 000	A1/A2	6.3	17	300		17	3.2	B5	TT
	TW1	902 310 000 0000	00	802 310 000		20				60		B5	R
	TW2	9X2 310 000 0000	00	892 310 000		30				60		B5	RR
	TX4	847 231 800 0000	50	645 231 700	G1	4	5	150		9	1.5	B7	TH
	TX4	057 231 800 0000	50	645 231 700	G1	4	1.5	300	90	5.5		B7	TH
	TX21	847 231 800 0000	50	645 231 700	G1	21	2	150		15	2.5	B7	TH
	TX21	057 231 800 0000	50	645 231 700	G1	21	1.5	250	90	5.5		B7	TH
	TX41	847 231 800 0000	50	645 231 700	G1	4	3	100		9	3.8	B7	TH
	TX41	057 231 800 0000	50	645 231 700	G1	4	2.5	250	100	3.2		B7	TH

SPEC.	VALVE TYPE NUMBER	PIN CONNECTIONS				CHARACTERISTICS						BASE	VALVE CLASS
		VCM163 Tester Only		CT160, VT160, VCM Mk 1,2,3,4		Vh	Vg1	Va	Vg2	la	gm mA/V		
		SELECTOR SWITCH	TOP CAP	SELECTOR SWITCH	TOP CAP	V	V	V	V	mA	†Ra MΩ		
	TY86F	230 232 032 0000	90	23* 232 *32	D1	7.5						B9A	R
	TZ40	204 300 000 0000	80	204 300 000	A1	7.5	1	100			0.4	UX4	T
	U4C	842 300 000 0000	00	642 300 000		4	12	200		35	3.2	B4	T
	U4E	842 300 000 0000	00	642 300 000		4	40	400		45	4	B4	T
	U4F	842 300 000 0000	00	642 300 000		4	40	400		45	4	B4	T
	U5	9X2 300 000 0000	00	892 300 000		5				15		B4	RR
	U8	9X2 300 000 0000	00	892 300 000		7.5				60		B4	RR
	U9	9X2 300 000 0000	00	892 300 000		4				30		B4	RR
	U10	9X2 300 000 0000	00	892 300 000		4				30		B4	RR
	U12	9X2 300 000 0000	00	892 300 000		4				60		B4	RR
	U14	9X2 300 000 0000	00	892 300 000		4				60		B4	RR
	U15	902 300 000 0000	00	802 300 000		6.3				120		B4	R
	U16	002 300 000 0000	90	002 300 000	D1	2				5		B4	R
	U17	002 300 000 0000	90	002 300 000	D1	5				30		B4	R
	U19	002 300 000 0000	90	002 300 000	D1	4				60		B4	R
	U19/23	002 300 000 0000	90	002 300 000	D1	4				60		B4	R
	U22	200 000 030 0000	90	200 000 030	D1	2				5		M08	R
	U22FH	200 000 030 0000	90	200 000 030	D1	2						M08	D
	U23	002 300 000 0000	90	002 300 000	D1	4				60		B4	R
	U24	030 000 200 0000	90	030 000 200	D1	2				1		AO8	R
	U25	023 000 000 0000	90	023 000 000	D1	2				120		B3G	D
	U26	3X1 221 900 0000	00	391 221 800		13				60		B7	RR
	U26	231 232 132 0000	90	231 232 132	D1	2				0.2		B9A	D
	U27	002 300 000 0000	90	002 300 000	D1	4				30		B4	R
	U29	002 300 000 0000	90	002 300 000	D1	2				5		B5	R
	U30	3X1 221 900 0000	00	391 221 800		13				60		B7	RR
	U30/250	902 300 000 0000	00	802 300 000		4				30		B4	R
	U31	020 090 310 0000	00	020 080 310		26				120		AO8	R
	U33	002 300 000 0000	90	002 300 000	D1	2				2		B4	R
	U35	020 000 030 0000	90	020 000 030	D1	1.4				2		AO8	R
	U37	023 000 000 0000	90	023 000 000	D1	1.4				0.5		B2G	D
	U41	020 000 300 0000	90	*2* 0*0 3*0	D1	1.2				1		AO8	D
	U43	023 000 000 0000	90	023 000 000	D1	6.3				0.5		B2G	D
	U49	230 232 032 0000	90	230 232 032	D1	2				0.2		B9A	D
	U51	030 X09 020 0000	00	030 908 020		5				120		AO8	RR
	U52	030 X09 020 0000	00	030 908 020		5				60		AO8	RR
	U52IT	009 0X0 230 0000	00	008 090 230		5				60		AO8	RR
	U54	030 X09 020 0000	00	030 908 020		5				60		AO8	RR
	U60	020 000 300 0000	90	*2* *** 3*0	D1	6.3						AO8	D
	U60/500	9X2 300 000 0000	00	892 300 000		4				60		B4	R
	U65/550	902 300 000 0000	00	802 300 000		7.5				60		B4	R
	U70	029 0X0 310 0000	00	028 090 310		6.3				30		AO8	RR
	U71	020 090 310 0000	00	020 080 310		30				60		AO8	R
	U74	020 090 310 0000	00	020 080 310		30				120		AO8	R
	U77	020 90X 020 0000	00	*20 809 020		5				180		AO8	RR
	U78	902 30X 100 0000	00	802 309 100		6.3				30		B7G	RR
	U81	00X 009 230 0000	00	009 008 230		6.3				60		B8B	RR
	U84	00X 009 230 0000	00	009 **8 230		4				30		B8B	RR
	U101	290 009 130 0000	00	280 008 130		50				120		B8B	R
	U107	291 009 300 0000	00	281 008 300		40				60		B7G	R



SPEC.	VALVE TYPE NUMBER	PIN CONNECTIONS				CHARACTERISTICS						BASE	VALVE CLASS
		VCM163 Tester Only		CT160, VT160, VCM Mk 1,2,3,4		Vh	Vg1	Va	Vg2	la	gm mA/V		
		SELECTOR SWITCH	TOP CAP	SELECTOR SWITCH	TOP CAP	V	V	V	V	mA	†Ra MΩ		
	U118	290 000 130 0000	00	280 *** 130		40				60		B8A	R
*	U119	001 230 009 0000	00	**1 23* **8		38				120		B9A	R
	U120/500	9X2 300 000 0000	00	892 300 000		2				120		B4	R
	U134	029 1X0 310 0000	00	028 190 310		13				60		AO8	RR
	U142	290 000 130 0000	00	280 000 130		31				60		B8A	R
	U143	020 X09 030 0000	00	020 908 030		4				30		AO8	RR
	U145	290 000 130 0000	00	280 000 130		40				60		B8A	R
	U147	029 0X0 310 0000	00	028 090 310		6.3				30		AO8	RR
	U149	20X 009 130 0000	00	209 008 130		6.3				30		B8B	RR
	U150	290 00X 130 0000	00	280 009 130		6.3				30		B8A	RR
	U152	001 230 009 0000	00	001 230 008		19				120		B9A	R
	U153	000 230 009 0000	10	*** 23* **8	C	17				120		B9A	R
	U154	001 230 009 0000	00	**1 23* **8		19				120		B9A	RR
	U191	000 090 230 0000	10	0** 080 230	C1	19				120		AO8	R
	U192	001 230 009 0000	00	**1 23* **6		19				120		B9A	R
	U193	000 230 009 0000	10	*** 23* **6	C1	19				120		B9A	R
	U201	020 090 310 0000	00	020 080 310		20				60		AO8	R
	U251	000 230 009 0000	10	*** 23* **8	C	25				120		B9A	R
	U281	020 090 310 0000	00	020 080 310		28				120		AO8	R
	U282	001 000 230 0000	90	001 000 230	D1	28				120		AO8	R
	U291	029 090 310 0000	00	028 08* 310		29				180		AO8	R
	U301	000 090 230 0000	10	0** 080 230	C	30				120		AO8	R
	U309	001 230 009 0000	00	**1 23* **8		20				120		B9A	R
	U329	000 230 009 0000	10	*** 23* **8	C	25				120		B9A	R
	U381	001 230 009 0000	00	**1 23* **8		38				120		B9A	R
	U403	201 090 030 0000	00	201 080 030		40				120		M08	R
	U404	290 000 130 0000	00	280 *** 130		40				60		B8A	R
	U415	842 300 000 0000	00	642 300 000		4	10.5	150		5	1.4	B4	T
	U418	842 300 000 0000	00	642 300 000		4	13	150		10	1.6	B4	T
	U650	902 300 000 0000	00	802 300 000		6.3				30		B4	R
	U709	901 230 X00 0000	00	8*1 23* 9**		6.3				60		B9A	RR
	U718	2X0 009 130 0000	00	29* **8 130		6.3				60		B8A	RR
	U801	129 9XX 310 0000	00	128 899 310		80				120		AO8	RR
	U2140P	3X1 221 900 0000	00	391 221 800		13				60		B7	RR
	U4020	902 310 000 0000	00	802 310 000		40				120		B5	R
	UA55	827 415 738 0000	00	625 414 537		55	6	90	90	36	7	B9A	PP
	UAA11	023 19X 100 0000	00	023 189 100		22				5		8SC	DD
	UAA91	192 310 X00 0000	00	182 310 900		19				5		B7G	RR
	UAA171	120 913 0X0 0000	00	120 813 090		25				5		B8B	DD
	UABC80	Y91 23X 148 0000	00	181 239 146		28	1	100		0.8	1.4	B9A	DDDT
	UAF21	287 914 130 0000	00	265 814 130		20	2	250	100	6	2.8	B8A	DP
	UAF41	289 174 130 0000	00	268 154 130		13	2	200	90	5	2	B8A	DP
	UB41	201 X09 130 0000	00	201 908 130		19				5		B8A	RR
	UB91	192 310 X00 0000	00	182 310 900		19						B7G	DD
	UBC1	208 091 X30 0000	40	206 081 930	G1	13	1.7	200		3	2	AO8	DDT
	UBC41	284 0X9 130 0000	00	264 098 130		14	1.6	200		1.5	1.6	B8A	DDT
	UBC81	841 239 0X0 0000	00	641 238 09*		14	1.5	200		1.5	1.6	B9A	DDT
	UBF2	208 791 X30 0000	40	206 581 930	G1	12.5	2	250	100	5	1.8	AO8	DDP
	UBF11	9X2 381 470 0000	00	892 361 450		20	2	200	75	5	1.8	F8	DDP

SPEC.	VALVE TYPE NUMBER	PIN CONNECTIONS				CHARACTERISTICS						BASE	VALVE CLASS
		VCM163 Tester Only		CT160, VT160, VCM Mk 1,2,3,4		Vh	Vg1	Va	Vg2	la	gm mA/V		
		SELECTOR SWITCH	TOP CAP	SELECTOR SWITCH	TOP CAP	V	V	V	V	mA	†Ra MΩ		
	UBF15	9X2 381 470 0000	00	892 361 450		27	2	250	100	12	5	F8	DDP
	UFB80	741 238 9X1 0000	00	541 236 891		17	2	200	125	5	2.2	B9A	DDP
	UBF89	741 238 9X1 0000	00	541 236 891		19	2	200	100	9	3.8	B9A	DDP
	UBF171	9X2 741 380 0000	00	892 541 360		20	3.2	250	75	6	1.8	B8B	DDP
	UBL1	208 791 X30 0000	40	206 581 930	G1	55	11.5	200	200	55	8.5	AO8	DDP
	UBL21	284 7X9 130 0000	00	264 598 130		55	13	200	200	55	8	B8B	DDP
	UBL3	023 19X 780 0000	40	023 189 560	G1	55	6	100	100	29	7.5	8SC	DDP
	UBL71	284 79X 130 0000	00	264 589 130		55	5.2	250	250	44	9.5	B8B	DDP
	UC88	414 234 484 0000	00	414 234 464		12		150		12.5	14	B9A	T
	UC92	802 304 100 0000	00	602 304 100		9.5	1	200		11.5	6.4	B7G	T
	UC95	142 380 100 0000	00	142 360 100		10.8	1.2	200		10	10.5	B7G	T
	UC96	412 314 800 0000	00	412 314 600		9.3	1	200		11.5	6.7	B7G	T
	UCC84	148 234 118 0000	00	147 234 116		21	1.5	90		12	6	B9A	TT
	UCC85	841 238 510 0000	00	641 237 410		26	2.1	200		10	5.8	B9A	TT
	UCC88	841 238 510 0000	00	641 237 410		21	1.2	90		15	12.5	B9A	TT
	UCC89	148 235 118 0000	00	146 234 117		21.6	1.2	90		15	12	B9A	TT
	UCC189	841 238 510 0000	00	641 237 410		21	1.2	90		15	12.5	B9A	TT
	UCF12	218 745 830 0000	50	642 371 450		20	1	100			3	F8	TP
	UCF12	218 745 830 0000	50	642 371 450		20	2	200	100	5	2	F8	TP
	UCF80	857 238 114 0000	00	645 237 114		27	2	100		14	5	B9A	TP
	UCF80	857 238 114 0000	00	645 237 114		27	2	200	175	10	6.2	B9A	TP
	UCH4	218 745 830 0000	50	217 544 630	G1	20	2	100		6	3	AO8	TH
	UCH4	218 745 830 0000	50	217 544 630	G1	20	2	200	100	5.2	2.2	AO8	TH
	UCH5	123 814 780 0000	50	123 644 570	G1	20	2	100		6.3	2.7	8SC	TH
	UCH5	123 814 780 0000	50	123 644 570	G1	20	2	250	100	6.5	2.6	8SC	TH
	UCH11	842 381 570 0000	00	642 371 450		20	2	100		5	2.4	F8	TH
	UCH11	052 381 570 0000	00	642 371 450		20	2	250	100	4.7	2.5	F8	TH
	UCH21	288 475 131 0000	00	276 454 131		20	7	100		6.4	2.2	B8B	TH
	UCH21	288 475 131 0000	00	276 454 131		20	2	200	90	5.2	2.2	B8B	TH
	UCH41	288 474 130 0000	00	276 454 130		14	2	100		6.4	2.2	B8A	TH
	UCH41	280 575 130 0000	00	276 454 130		14	2	200	90	2.7	1.7	B8A	TH
	UCH43	288 475 130 0000	00	276 454 130		14	2	100		5	2	B8A	TH
	UCH43	280 575 130 0000	00	276 454 130		14	2	200	75	8	2.2	B8A	TH
	UCH71	288 475 131 0000	00	276 454 131		20	2	100		16.4	2.2	B8B	TH
	UCH71	288 475 131 0000	00	276 454 131		20	2	200	90	5.2	2.2	B8B	TH
	UCH80	741 238 885 0000	00	541 236 764		14.5	2	75		5.1		B9A	TP
	UCH80	741 238 885 0000	00	541 236 764		14.5		250	85	3		B9A	TP
	UCH81	741 238 185 0000	00	541 236 764		19	3	100		5	2.3	B9A	TP
	UCH81	741 238 185 0000	00	541 236 764		19	2.6	200	125	7.6	2.4	B9A	TP
	UCH717	842 755 380 0000	00	642 544 370		20		200		3		B8B	TP
	UCH717	842 755 380 0000	00	642 544 370		20	2.5	200	100	2	0.7	B8B	TP
	UCL11	572 381 480 0000	00	452 371 460		60	2	200		2	2.1	F8	TP
	UCL11	572 381 480 0000	00	452 371 460		60	8.5	200	200	45	9	F8	TP
	UCL81	471 238 815 0000	00	451 237 614		39	1.9	150		1.3	1.6	B9A	TP
	UCL81	471 238 815 0000	00	451 237 614		39	7	200	200	30	8.7	B9A	TP
	UCL82	415 238 718 0000	00	414 237 516		50	1	200		3.7	2.5	B9A	TP
	UCL82	415 238 718 0000	00	414 237 516		50	16	200	200	35	6.4	B9A	TP
	UCL83	841 238 175 0000	00	641 137 154		40	1.5	200		2.4	2.5	B9A	TP
	UCL83	841 238 175 0000	00	641 137 154		40	9.5	200	175	30	5.5	B9A	TP
	UCL84	481 238 157 0000	00	461 237 145		45	1.7	200		3	4	B9A	TP
	UCL84	481 238 157 0000	00	461 237 145		45	2.1	200	175	18		B9A	TP
	UCL86	417 238 158 0000	00	415 237 146		44	1.7	250		1.2	1.6	B9A	TP
	UCL86	417 238 158 0000	00	415 237 146		44	7	250	250	36	10	B9A	TP

SPEC.	VALVE TYPE NUMBER	PIN CONNECTIONS				CHARACTERISTICS						BASE	VALVE CLASS
		VCM163 Tester Only		CT160, VT160, VCM Mk 1,2,3,4		Vh	Vg1	Va	Vg2	la	gm mA/V		
		SELECTOR SWITCH	TOP CAP	SELECTOR SWITCH	TOP CAP	V	V	V	V	mA	†Ra MΩ		
	UD2	842 300 000 0000	00	642 300 000		2	12	150		14	2.5	B4	T
	UDDL71	023 19X 780 0000	40	023 189 560	G1	44	10	200	200	60	9	8SC	DD
	UDH	902 310 000 0000	00	803 310 000		20				60		B5	R
	UDP12	023 190 780 0000	40	023 180 560	G1	40	10	200	200	60	9	8SC	DP
	UDP13	028 790 310 0000	40	026 580 310	G1	40	10	200	200	60	9	AO8	DP
	UDT1	023 19X 080 0000	40	023 189 060	G1	15	3	200		10.3	3	8SC	DD
	UE1	023 100 090 0000	00	023 100 080		25				60			-
	UE2	123 190 0X0 0000	00	123 180 090		50				60		8SC	RR
	UE13	020 090 310 0000	00	020 080 310		25				60		AO8	R
	UE100	209 000 130 0000	00	208 0*0 130		50						AO8	R
	UEL11	572 381 780 0000	40	452 371 560	G	48		100	300	2.4	1.6	F8	PP
	UEL11	572 381 780 0000	40	452 371 560	G	48	6	200	200	22	5	F8	PP
	UF5	023 110 780 0000	40	023 110 560	G1	12.5	2.5	100	100	3.2	2.2	8SC	P
	UF6	023 110 780 0000	40	023 110 560	G1	12.5	20	100	100	3	1.8	8SC	P
	UF8	208 711 130 0000	40	206 511 130	G1	12	2	200		6	1.6	B8B	P
	UF9	208 701 130 0000	40	206 501 130	G1	12.5	2.5	200	100	6	2.2	AO8	P
	UF10	023 110 780 0000	40	023 110 560	G1	12.5	2.4	200	100	5.5	2.4	8SC	P
	UF11	802 301 470 0000	00	602 301 450		15	2	200	75	6	2.2	F8	P
	UF14	812 370 140 0000	00	612 350 140		25	5	200	200	12	7	F8	P
	UF15	812 301 470 0000	00	612 301 450		25	2	200	100	12	5.5	F8	P
	UF21	287 104 130 0000	00	265 104 130		12.5	2.5	200	100	6	2.2	B8B	P
	UF40	280 047 130 0000	00	260 045 130		12.6	2	200	150	3	1.8	B8D	P
	UF41	280 074 130 0000	00	26* *54 130		12.5	3	200	125	7.2	2.3	B8A	P
	UF42	280 174 130 0000	00	260 154 130		21	2	200	175	10	8.5	B8A	P
	UF43	280 174 130 0000	00	260 154 130		21	2	200	125	15	6.3	B8A	P
	UF80	141 230 871 0000	00	141 230 651		19	2	200	170	10	7.4	B9A	P
	UF81	741 238 000 0000	00	541 236 000		12.6	2.5	250	125	6	2.2	B9A	P
	UF85	141 231 871 0000	00	141 231 651		19	2	200	100	9.7	5.9	B9A	P
	UF86	701 238 014 0000	00	501 236 014		12.6	2	200	150	3	1.8	B9A	P
	UF89	041 230 871 0000	00	041 230 651		12.6	2	200	100	9	3.8	B9A	P
	UF172	112 740 380 0000	00	112 540 360		20	2	200	100	4.5	3	B8B	P
	UF174	112 740 380 0000	00	112 540 360		30	3	200	150	12	8	B8B	P
	UF175	112 740 380 0000	00	112 540 360		30	2	200	75	10	5.7	B8B	P
	UF183	141 230 871 0000	00	141 230 651		18.9	2	200	90	12	12.5	B9A	P
	UF184	141 230 871 0000	00	141 230 651		18.9	2.5	200	200	10	15	B9A	P
	UH3	023 110 780 0000	00	023 110 560		13	3	250	100	8	2.2	8SC	P
	UH4	9X3 200 000 0000	00	893 200 000		4				5		B5	RR
	UHP51	023 110 780 0000	00	023 110 560		13	2.5	250	100	3.5	2	8SC	P
	UL1	108 740 130 0000	00	206 540 130		60	11.5	200	200	55	8.5	AO8	P
	UL2	023 104 780 0000	00	023 104 560		35	5	200	200	20	7	8SC	P
	UL11	802 301 470 0000	00	602 301 450		45	14	200	200	45	9	F8	P
	UL12	802 301 470 0000	00	602 301 450		60	8	200	125	75	12	F8	P
	UL21	287 004 130 0000	00	265 004 130		45	13	200	200	55	8	B8B	P
	UL22	287 004 130 0000	00	265 004 130		46	10	200	175	61	9	B8B	P
	UL41	280 074 130 0000	00	26* *54 130		45	9	200	175	54	9.5	B8A	P
	UL43	280 174 130 0000	00	260 154 130		50	2.6	250	250	36	10	B8A	P
	UL44	200 174 130 0000	80	200 154 130	A1	45	13.5	200	175	28.5	7	B8A	P
	UL46	281 074 130 0000	00	261 054 130		45	9	200	175	54	9.5	B8A	P
	UL71	284 700 130 0000	00	264 500 130		45	5.2	200	200	22	6.5	B8B	P
	UL84	041 230 807 0000	00	*41 23* 6*5		45	12.5	200	175	70	10	B9A	P
	UL171	102 741 380 0000	00	102 541 360		55	8.5	200	200	45	9	B8D	P

SPEC.	VALVE TYPE NUMBER	PIN CONNECTIONS				CHARACTERISTICS						BASE	VALVE CLASS
		VCM163 Tester Only		CT160, VT160, VCM Mk 1,2,3,4		Vh	Vg1	Va	Vg2	la	gm mA/V		
		SELECTOR SWITCH	TOP CAP	SELECTOR SWITCH	TOP CAP	V	V	V	V	mA	†Ra MΩ		
	ULL80	748 235 187 0000	00	546 234 175		25		250	250	24		B9A	PP
	ULP	842 310 000 0000	00	642 310 000		13	20	250		27	4	B5	T
	ULP51	823 147 000 0000	00	623 145 000		40	17	250	250	36	2.5	8SC	P
	ULP61	023 100 780 0000	40	023 100 560	G1	33	8	200	200	55	9	8SC	P
	UM4	208 748 130 0000	00	206 546 130		12.6	4.2	200	200		†1.0	AO8	TI
	UM4	208 748 130 0000	00	206 546 130		12.6	12.5	200	200		†1.0	AO8	TI
	UM11	208 748 130 0000	00	206 546 130		15	4.2	200	200		†1.0	AO8	TI
	UM11	208 748 130 0000	00	206 546 130		15	12.5	200	200		†1.0	AO8	TI
	UM34	028 748 310 0000	00	026 456 310		12.6	4.2	250	250		†1.0	AO8	TI
	UM34	028 748 310 0000	00	026 456 310		12.6	12.5	250	250		†1.0	AO8	TI
	UM80	410 230 807 0000	00	41* 23* 6*5		19	14	200	200	0.4	†0.5	B9A	TI
	UM81	410 230 807 0000	00	41* 23* 6*5		19	14	200	200	0.4	†0.5	B9A	TI
	UM84	401 237 808 0000	00	4*1 235 6*6		12.6	22	250	250	0.4	†0.5	B9A	TI
	UM85	401 237 808 0000	00	401 235 607		19	13	200		1	†0.2	B9A	TI
	UM85	401 237 80X 0000	00	401 235 607		19	13	200	200	1	0.2	B9A	-
	UN955	213 480 000 0000	00	213 460 000		6.3	7	250		6.3	2.2	5AA	T
	UP	9X2 300 000 0000	00	892 300 000		4				30		B4	RR
	UP2	023 140 780 0000	00	023 140 560		25	19	200	100	40	3	8SC	P
	UP6	023 100 780 0000	40	023 100 560	G1	35	8	200	200	55	9	8SC	P
	UP13	028 740 310 0000	00	026 540 310		35	8	200	200	55	9	AO8	P
	UP13	040 231 700 0000	80	040 231 500	A1	13	1	200	100		3	B7	P
	UP35U	023 100 780 0000	40	023 100 560	G1	35	8	200	200	55	9	8SC	P
	UPX	842 310 000 0000	00	642 310 000		25	34	250		38	7	B5	T
	UQ80	741 238 114 0000	00	541 236 114		12	1	250	20	0.9	7	B9A	P
	UR1	023 100 090 0000	00	023 100 080		20				60		8SC	R
	UR1C	902 310 000 0000	00	802 310 000		20				60		B5	R
	UR2	123 190 0X0 0000	00	123 180 090		30				60		8SC	RR
	UR3C	9X1 231 900 0000	00	091 231 800		30				60		B7	RR
	UT2	023 100 080 0000	40	023 100 060	G1	15	5	100		6	3	8SC	T
	UTH4	523 184 780 0000	50	423 164 570	G1	17		100		4	2	8SC	TH
	UTH4	523 184 780 0000	50	423 164 570	G1	17	2.5	200	90	3	0.8	8SC	TH
	UTH12	523 184 780 0000	50	423 164 570	G1	17		100		4	2	8SC	TH
	UTH12	523 184 780 0000	50	423 164 570	G1	17	2.5	250	30	3	0.7	8SC	TH
	UU2	9X2 300 000 0000	00	892 230 000		4				30		B4	RR
	UU3	9X2 300 000 0000	00	892 300 000		4				30		B4	RR
	UU5	9X2 300 000 0000	00	892 300 000		4(5)				60		B4	RR
	UU6	209 0X0 030 0000	00	208 090 030		4				60		M08	RR
	UU7	209 0X0 030 0000	00	209 090 030		4				60		M08	RR
	UU8	209 0X0 030 0000	00	208 090 030		4				120		M08	RR
	UU9	2X0 009 130 0000	00	290 008 130		6.3				30		B8A	RR
	UU10	9X2 300 000 0000	00	892 300 000		4				60		B4	RR
	UU12	901 230 X00 0000	00	8*1 23* 9**		6.3				60		B9A	RR
	TJU30/250	9X2 300 000 0000	00	892 300 000		4				15		B4	RR
	UVG51	123 1X0 090 0000	00	123 190 080		30				60		8SC	RR
	UY1	399 029 120 0000	00	388 028 120		50				120		AO8	R
	UY1NS	309 020 120 0000	00	3*8 02* 120		50				120		AO8	R
	UY2	023 190 000 0000	00	023 180 000		26				30		F8	R
	UY3	023 100 090 0000	00	023 100 080		50				120		8SC	R
	UY4	023 100 090 0000	00	023 100 080		35				30		8SC	R
	UY11	902 300 100 0000	00	802 300 100		50				120		F8	R
	UY21	290 900 130 0000	00	280 80* 130		50				120		B8B	R
	UY22	290 909 130 0000	00	280 80* 130		26				60		B8B	R

SPEC.	VALVE TYPE NUMBER	PIN CONNECTIONS				CHARACTERISTICS						BASE	VALVE CLASS
		VCM163 Tester Only		CT160, VT160, VCM Mk 1,2,3,4		Vh	Vg1	Va	Vg2	la	gm mA/V		
		SELECTOR SWITCH	TOP CAP	SELECTOR SWITCH	TOP CAP	V	V	V	V	mA	†Ra MΩ		
	UY31	020 090 310 0000	00	020 080 310		50				120		AO8	R
	UY42	290 000 130 0000	00	280 -0* 130		31				60		B8A	R
	UY82	001 230 009 0000	00	**1 23* **8		55				180		B9A	R
	UY85	001 230 009 0000	00	**1 23* **8		38				120		B9A	R
	UY89	101 230 009 0000	00	1*1 23* **8		31				60		B9A	R
	UY91	912 390 900 0000	00	812 380 800		26				60		B7G	R
	UY92	002 390 100 0000	00	**2 38* 100		26				60		B7G	R
	V2M70	902 30X 100 0000	00	802 309 100		6.3				30		B7G	RR
	V20	902 310 000 0000	00	802 310 000		20				60		B5	RR
	V20/7000	002 300 000 0000	90	002 300 000	D1	4				15		B4	R
	V20S	023 100 090 0000	00	023 100 080		20				60		8SC	R
	V22/7000	000 010 100 0000	90	000 010 100	D1	6.3				5		B8B	D
	V25	091 231 X00 0000	00	081 231 900		25				60		B7	RR
	V30	902 310 000 0000	00	802 310 000		30				120		B5	R
	V30/1	002 300 000 0000	90	002 300 000	D1	2						B4	D
	V41	090 00X 230 0000	00	*8* **9 230		4				30		B8B	RR
	V51	290 00X 130 0000	00	280 009 130		5				30		B8A	RR
	V61	290 00X 130 0000	00	28* **9 130		6.3				30		B8A	RR
	V99	283 400 000 0000	00	263 400 000		3	4.5	90		2.5	0.4	UX4	T
	V226	041 230 700 0000	80	041 230 500	A1	6.3	5	400	250	14	3	B7	P
	V245	041 240 700 0000	80	041 240 500	A1	3		250	250	16	5	B7	P
	V248A	200 740 030 0000	80	200 540 030	A1	2	10	150	150	32	5.2	M08	P
	V311	290 000 130 0000	00	28* **9 130		31				60		B8A	R
	V312	802 310 000 0000	40	602 310 000	G1	4	4.8	250		6	2.3	B5	T
	V339	000 231 800 0000	40	000 231 600	G1	4		250			1.7	B7	T
	V453	218 710 030 0000	40	216 510 030	G1	4	1.8	250	100	4.5	2	M08	P
	V503	842 300 000 0000	00	642 300 000		4	85	400		100	4.5	B4	T
	V872	218 710 030 0000	40	216 510 030	G1	6.3	4	200	200	6.7	3.4	M08	P
	V884	412 381 700 0000	00	412 361 500		6.3	2.5	250	200	8	2.5	B7G	P
	V914	9X2 310 000 0000	00	892 310 000		4						B5	DD
	V960	002 300 000 0000	90	002 300 000	D1	4				60		B4	R
	V1120	047 231 000 0000	80	045 231 000	A1	6.3	9.8	200	200	40	8.7	B7	P
	V11208	040 231 700 0000	80	040 231 500	A1	4(5)	9.8	200	200	40	8.7	B7	P
	V1906	002 300 000 0000	90	002 300 000	D1	4(5)				60		B4	R
	V1928	112 311 100 0000	90	112 311 100	D1	4				5		B7G	R
	V2018	002 300 000 0000	90	002 300 000	D1	20				30		B4	R
	V2118	902 310 000 0000	00	802 310 000		20				60		B5	R
	V4200	802 300 000 0000	00	802 300 000		4				120		B4	R
	VBF11	9X2 381 470 0000	00	892 361 450		35	2	200	75	5	1.9	F8	DDP
	VC1	023 100 080 0000	40	023 189 060	G1	55	2	200		6	3	8SC	DDT
	VC1	023 19X 080 0000	40	023 189 060		55	2	200		6	3	8SC	DDT
	VCH11	842 381 570 0000	00	642 371 450		40		100		4	2	F8	TH
	VCH11	052 381 570 0000	00	642 371 450		40	2.5	250	90	3	0.7	F8	TH
	VCL11	572 381 480 0000	00	452 371 460		90	0.5	100		2	2.4	F8	TH
	VCL11	572 381 480 0000	00	452 371 460		90	4.5	200	200	12	5	F8	TH
	VDS	742 310 000 0000	80	542 310 000	A1	16	2	200	75		1.6	B5	P
	VDSB	742 310 000 0000	80	542 310 000	A1	16	1	200	75	5	3	B5	P
	VEG51	023 100 090 0000	00	023 100 080		20				60		8SC	R
	VEL11	472 381 780 0000	50	452 371 560		90		100	30	2.4	1.6	F8	PP
	VEL11	472 381 780 0000	50	452 371 560		90	6	200	200	22	5	F8	PP
	VF3	023 110 780 0000	40	023 110 560	G1	55	2.5	250	100	5	2	8SC	P
	VF14	812 370 140 0000	00	612 340 140		60	4.5	250	250	12	7	F8	P

SPEC.	VALVE TYPE NUMBER	PIN CONNECTIONS				CHARACTERISTICS						BASE	VALVE CLASS
		VCM163 Tester Only		CT160, VT160, VCM Mk 1,2,3,4		Vh	Vg1	Va	Vg2	Ia	gm mA/V		
		SELECTOR SWITCH	TOP CAP	SELECTOR SWITCH	TOP CAP	V	V	V	V	mA	†Ra MΩ		
	VFT4	028 740 310 0000	00	026 540 310		4	22	250	250	0.2	†1.0	AO8	TI
	VG406	9X2 300 000 0000	00	892 300 000		4				30		B4	RR
	VG411	9X2 300 000 0000	00	892 300 000		4				60		B4	RR
	VG421	9X2 300 000 0000	00	892 300 000		4				60		B4	RR
	VG2908	9X2 300 000 0000	00	892 300 000		2.5				30		B4	RR
	VG3016	9X2 300 000 0000	00	892 300 000		4				60		B4	RR
	VG3630	9X2 300 000 0000	00	892 300 000		4				120		B4	RR
	VG5006	9X2 300 000 0000	00	892 300 000		4				60		B4	RR
	VG5007	023 090 0X0 0000	00	023 080 090		4				60		8SC	RR
	VG5107	902 300 0X0 0000	00	802 300 090		4				60		F8	RR
	VH2	912 390 100 0000	00	812 380 100		6.3				5		B7G	D
	VH3	142 384 100 0000	00	142 364 100		6.3	4.5	150		13	5	B7G	T
	VH5	412 387 100 0000	00	412 365 100		6.3	2	200	125	7.7	5.1	B7G	P
	VHP13	041 231 700 0000	80	041 231 500	A1	13	1.5	200	100	4	2	B7	P
	VHT2	847 230 800 0000	40	645 230 600	G1	2		150	75			B4	H
	VHT2A	847 230 800 0000	40	645 230 600	G1	2		150	50			B7	H
	VHT4	747 231 800 0000	40	545 231 600	G1	4	3	200	100	3.6		B7	H
	VHTA	123 184 770 0000	40	123 164 550	G1	13	1.5	250	100	3.2		8SC	H
	VHTA	747 231 800 0000	40	545 231 600	G1	13	1.5	200	100	3.2		B7	H
	VHTS	847 231 700 0000	40	645 231 500	G1	13	3	200	100	2.6		B7	H
	VHTS	747 231 800 0000	40	-		13	3	200	100			B7	H
	VL1	023 100 780 0000	40	023 100 560	G1	55	14	200	200	25	2.2	8SC	P
	VL4	023 100 780 0000	40	023 100 560	G1	110	8.5	200	200	45	8	8SC	P
	VLS61	002 300 000 0000	90	002 300 000	D1	2				3		B4	R
	VM1	200 000 300 0000	90	2** 00* 300	D1	1.4						B7G	D
	VM3R	047 231 800 0000	00	045 231 600		4	22	250	250	0.2		B7	TI
	VM4V	742 310 000 0000	80	542 310 000	A1	4	1	200	80	14	2.4	B5	P
	VME4	047 231 800 0000	00	045 231 600		4	22	250	250		†1.0	B7	TI
	VMP4	041 231 700 0000	80	041 231 500	A1	4	2	250	100	3	3.5	B7	P
	VMP4	742 310 000 0000	80	542 310 000	A1	4	1	250	100	5	3.5	B5	P
	VMP4G	041 231 700 0000	80	041 231 500	A1	4	2	250	100	8	2.7	B7	P
	VMS4	742 310 000 0000	80	542 310 000	A1	4	1	200	80	11	2.1	B5	P
	VMS4B	742 310 000 0000	80	542 310 000	A1	4	1	200	80	5.2	2.4	B5	P
	V02	847 320 800 0000	40	645 320 600	G1	2		150	90	1.8		B7	O
	V02S	023 084 780 0000	40	023 064 560	G1	2		150	50	2		8SC	O
	V04	847 231 700 0000	40	645 231 500	G1	4	1.5	250	75	1.6		B7	O
	V04S	023 174 780 0000	40	023 154 560	G1	4	1.5	250	75	1.6		8SC	O
	V06	123 184 780 0000	40	123 164 560	G1	6.3	3	100	100	4.6		8SC	O
	V013	847 231 700 0000	40	645 231 500	G1	13	1.5	250	75	1.6		B7	O
	V013S	123 174 780 0000	40	123 154 560	G1	13	1.5	250	75	1.6		8SC	O
	V0133	023 184 780 0000	50	023 164 570	G1	13	1	100		1	1.2	B7	TH
	V0133	023 184 780 0000	50	023 164 570	G1	13	1	200	75		1.7	B7	TH
	VP2	041 230 700 0000	80	041 230 500	A1	2	1	150	150	3	1.5	B7	P
	VP2B	081 230 700 0000	40	061 230 500	G1	2	1.5	150	150	1.6	0.7	B7	P
	VP2B	032 004 780 0000	00	065 231 500	G1	2	1.5	150	60	2	1.4	B7	H
	VP2B	087 231 700 0000	40	032 004 560		2	15	150	150	2.5	0.7	8SC	P
	VP2BS	032 010 780 0000	40	032 010 560	G1	2	1	150	150	2.5	0.7	8SC	P
	VP2D	081 230 700 0000	40	061 230 500	G1	2	1.5	150	75	1.3	2	B7	P
	VP3	023 110 780 0000	40	023 110 560	G1	55	2.5	250	100	5	2	8SC	P
	VP4	041 231 700 0000	80	542 310 000	A1	4	2	200	100	4.5	2.3	B5	P
	VP4	041 231 700 0000	80	041 231 500	A1	4	2	200	100	4.5	2.3	B7	P
	VP4C	041 231 700 0000	80	041 231 500	A1	4	2	250	250	11.5	4	B7	P

SPEC.	VALVE TYPE NUMBER	PIN CONNECTIONS				CHARACTERISTICS						BASE	VALVE CLASS
		VCM163 Tester Only		CT160, VT160, VCM Mk 1,2,3,4		Vh	Vg1	Va	Vg2	la	gm mA/V		
		SELECTOR SWITCH	TOP CAP	SELECTOR SWITCH	TOP CAP	V	V	V	V	mA	†Ra MΩ		
	VP4S	023 110 780 0000	40	023 110 560	G1	4	2	250	100	8	1.8	8SC	P
	VP4S	081 231 700 0000	40	061 231 500	G1	4	3	250	100	8	1.8	B7	P
	VP6	412 381 700 0000	00	412 361 500		6.3	2.5	250	200	8	2.1	B7G	P
	VP6	081 231 700 0000	40	061 231 500	G1	6.3	3	250	100	7.5	1.7	B7	P
	VP6S	023 110 780 0000	40	023 110 560	G1	6.3	3	250	100	7.5	1.8	8SC	P
	VP12D	028 X97 310 0000	40	026 985 310	G1	13	3	250	125	9	1.1	AO8	DDP
	VP13	041 231 700 0000	80	041 231 500	A1	13	1.5	200	100	6.3	3	B7	P
	VP13	081 231 700 0000	40	061 231 500	G1	13	3	200	100	8	2.8	B7	P
	VP13A	023 110 780 0000	40	023 110 560	G1	13	2	200	100	4	2.2	8SC	P
	VP13B	081 231 700 0000	40	061 231 500	G1	13	2	200	200	9	2.2	B7	P
	VP13S	081 231 700 0000	40	061 231 500	G1	13	3	200	100	8	2.8	B7	P
	VP13S	023 110 780 0000	40	023 110 560	G1	13	3	200	100	3	2.8	8SC	P
	VP20	742 310 000 0000	80	542 310 000	A1	20	2	200	100	4	2.2	B5	P
	VP21	041 230 700 0000	80	041 230 500	A1	2	1	150	60	1.8	1.1	B7	P
	VP22	208 710 030 0000	40	206 510 030	G1	2	1.5	150	60	1.2	0.8	M08	P
	VP41	218 710 030 0000	40	216 510 030	G1	4	2.7	250	250	7.7	2	M08	P
	VP41	081 231 700 0000	40	061 231 500	G1	4	3.3	250	250	11	2	B7	P
	VP133	218 710 030 0000	40	216 510 000	G1	13	2.7	150	150	8	2.1	M08	P
	VP210	041 230 700 0000	80	041 230 500	A1	2	1.5	150	60	1.1	0.8	B7	P
	VP210	742 300 000 0000	80	542 300 000	A1	2	1.5	150	60	1.1	0.8	B4	P
	VP215	742 300 000 0000	80	542 300 000	A1	2	1.5	150	75	2	0.7	B4	P
	VP215	041 230 700 0000	80	041 230 500	A1	2	1.5	150	75	2	0.7	B7	P
	VP215B	081 230 700 0000	40	061 230 500	G1	2	1.5	150	125	1.5	1	B7	P
	VP215C	041 230 700 0000	80	041 230 500	A1	2	1.5	150	125	1.5	1	B7	P
	VP1320	041 231 700 0000	80	041 231 500	A1	13	2.7	250	100	5	2	B7	P
	VP1321	041 231 700 0000	80	041 231 500	A1	13	2.8	200	200	7.4	2	B7	P
	VP1322	081 231 700 0000	40	061 231 500	G1	13	2.8	250	200	7.4	2	B7	P
	VPT2	742 300 000 0000	80	542 300 000	A1	2	1.5	150	60	1.5	1.1	B4	P
	VPT2	041 230 700 0000	80	041 230 500	A1	2	1.5	150	60	1.5	1.1	B7	P
	VPT4	041 231 700 0000	80	542 310 000	A1	4	3	250	100	5.5	2	B5	P
	VPT4	742 310 000 0000	80	041 231 500	A1	4	3	250	100	5.5	2	B7	P
	VPT4B	041 231 700 0000	80	041 231 500	A1	4	3	250	100	6	3.2	B7	P
	VPTA	041 231 700 0000	80	041 231 500	A1	13	2	250	100	4.2	2.9	B7	P
	VPTS	041 231 700 0000	80	041 231 500	A1	13	3	200	100	5.5	2.6	B7	P
	VPU1	080 231 700 0000	40	060 231 500	G1	13	1	250	200		3.5	B7	P
	VSGA1	742 310 000 0000	80	542 310 000	A1	4	1.5	200	100	7	6.1	B5	P
	VT1	842 310 000 0000	00	642 310 000		4	5	200		5	2	B5	T
	VT2	842 310 000 0000	00	642 310 000		4	2	200		3	1.9	B5	T
	VT121	285 310 000 0000	00	264 310 000		6.3	7	250		6.3	2.2	5AA	T
	VTF6	028 740 310 0000	00	026 540 310		6.3	22	200	200	0.2	†1.0	AO8	TI
	VTP4	742 310 000 0000	80	542 310 000	A1	4	3	200	100	5.5	2	B5	P
	VX2	081 237 700 0000	40	061 235 500	G1	2	1	150	60	1	0.5	B7	H
	VX2S	023 017 780 0000	40	023 015 560	G1	2	1	150	60	1	0.5	8SC	H
	VX4	717 231 800 0000	40	515 231 600	G1	4	2	250	75	1.8	0.5	B7	H
	VX4S	023 117 780 0000	40	023 115 560	G1	4	2	250	75	1.8	0.5	8SC	H
	VX6S	023 117 780 0000	40	023 115 560	G1	6.3	3	250	100	1.9	4	8SC	P
	VX13	717 231 800 0000	40	515 231 600	G1	13	2	250	75	1.8		B7	P
	VX13S	023 117 780 0000	40	023 115 560	G1	13	2	250	75	1.8		8SC	H
	VX8045	402 183 700 0000	00	402 163 500		6.3	1.4	100	100	7	5	B8D	P
	VX8046	402 873 180 0000	00	402 653 160		6.3	2	100	100	7.5	5.3	B8D	P

SPEC.	VALVE TYPE NUMBER	PIN CONNECTIONS				CHARACTERISTICS						BASE	VALVE CLASS
		VCM163 Tester Only		CT160, VT160, VCM Mk 1,2,3,4		Vh	Vg1	Va	Vg2	la	gm mA/V		
		SELECTOR SWITCH	TOP CAP	SELECTOR SWITCH	TOP CAP	V	V	V	V	mA	†Ra MΩ		
	VX8054	412 073 700 0000	00	412 053 500		6.3	9	100	100	31	5	B8D	P
	VY1	023 100 090 0000	00	023 100 080		55				60		8SC	R
	VY2	023 190 000 0000	00	023 180 000		30				15		8SC	R
	VY2N	023 100 090 0000	00	023 100 080		30				15		8SC	R
	W4	842 300 000 0000	00	642 300 000		4	7.5	150		3	1.2	B4	T
	W4-500	9X2 300 000 0000	00	892 300 000		4				60		B4	RR
	W30	041 231 700 0000	80	041 231 500	A1	13	1	250	250	12	4	B7	P
	W31	041 231 700 0000	80	041 231 500	A1	13	3	250	100	8	2.7	B7	P
	W42	081 231 700 0000	40	061 231 500	G1	4	3	250	100	7.6	1.5	B7	P
	W61	028 710 310 0000	40	026 510 310	G1	6.3	3	250	75	8.5	2.9	AO8	P
	W63	028 710 310 0000	40	026 510 310	G1	6.3	3	250	100	7.6	1.5	AO8	P
	W101	287 104 130 0000	00	265 104 130		19	3	250	100	8	2.8	B8B	P
	W107	412 381 700 0000	00	412 361 500		12.5	2.5	200	200	8	2.5	B7G	P
	W119	141 230 871 0000	00	141 230 651		13	1.3	200	100	13	4.4	B9A	P
	W145	280 174 130 0000	00	260 154 130		13	2.5	200	100	7	2.3	5BA	P
	W148	287 140 130 0000	00	265 140 130		6.3	2.5	250	150	9.5	2.8	B8B	P
	W149	287 104 130 0000	00	265 104 130		6.3	3	250	100	8.5	†.8	B8B	P
	W213	842 300 000 0000	00	642 300 000		2	2.5	150		1	1.2	B4	T
	W216	040 120 780 0000	00	040 120 560		2	1.5	150	90	3	1.2	B7	P
	W318	90X 231 800 0000	40	809 231 600	G1	4	2	100		3.5	2.5	B7	DDT
	W406	842 300 000 0000	00	642 300 000		4	7.5	150		3	1.2	B4	T
	W411	842 300 000 0000	00	642 300 000		4	2.5	150		3	2.2	B4	T
	W412	842 300 000 0000	00	642 300 000		4	7.5	150		3	1.2	B4	T
	W415N	842 310 000 0000	00	642 310 000		4	2.5	200		2.5	1	B5	T
	W420	842 300 000 0000	00	642 300 000		4	4	150		4	1.3	B4	T
	W4080	842 310 000 0000	00	642 310 000		4	2.5	200		2.5	1	B5	T
	W4110	842 310 000 0000	00	642 310 000		4	1.5	200		1	3	B5	T
	WD2	842 300 000 0000	00	642 300 000		2	2.5	150		1	1	B4	T
	WD30	780 231 9X0 0000	40	560 231 890	G1	13	1	250	100	7	2.6	B9	DDP
	WD40	780 231 9X0 0000	40	560 231 890	G1	4	1	250	100	7	3.5	B9	DDP
	WD70	741 238 9X1 0000	00	541 236 891		6.3	2	250	90	5	2.2	B9A	DDP
	WD119	741 238 9X1 0000	00	541 236 891		19	1.5	200	100	11	4.5	B9A	DDP
	WD142	289 174 130 0000	00	268 154 130		13	2	200	90	5	2.1	B8A	DP
	WD150	289 174 130 0000	00	268 154 130		6.3	2	250	100	5	2.1	B8A	DP
	WD709	741 238 9X1 0000	00	541 236 891		6.3	2	250	90	5	2.2	B9A	DDP
	WE23	742 310 000 0000	80	542 310 000	A1	4	2	200	100	3	2.5	B5	P
	WE24	742 310 000 0000	80	542 310 000	A1	4		200	100	3	2.5	B5	P
	WE27	842 310 000 0000	00	642 310 000		4	3.5	200		6	2.4	B5	T
	WE28	842 310 000 0000	00	642 310 000		4	1.5	200		1	2.5	B5	T
	WE29	842 310 000 0000	90	642 310 000	D1	4	3	200		6	2	B5	DT
	WE30	842 370 000 0000	00	642 350 000		4	15	250	250	36	2.8	B5	P
	WE33	023 110 780 0000	40	023 110 560	G1	4	3	100	250	8	1.9	8SC	P
	WE35	023 004 780 0000	00	023 004 560		4	15	250	250	15	2.8	8SC	P
	WE37	023 19X 080 0000	40	023 189 060	G1	4	7	250		4	2	8SC	DDT
	WE38	023 104 780 0000	00	023 104 560		4	6	250	250	36	9	8SC	P
	WE39	023 100 080 0000	40	023 100 060	G1	4	5.5	250		6	2.5	8SC	P
	WE51	9X2 300 000 0000	00	892 300 000		4				30		B4	RR
	WE52	9X2 300 000 0000	00	892 300 000		2				60		B4	RR
	WE53	023 090 0X0 0000	00	023 080 090		4				60		8SC	RR
	WE54	023 090 0X0 0000	00	023 080 090		4				30		8SC	RR



SPEC.	VALVE TYPE NUMBER	PIN CONNECTIONS				CHARACTERISTICS						BASE	VALVE CLASS
		VCM163 Tester Only		CT160, VT160, VCM Mk 1,2,3,4		Vh	Vg1	Va	Vg2	Ia	gm mA/V		
		SELECTOR SWITCH	TOP CAP	SELECTOR SWITCH	TOP CAP	V	V	V	V	mA	†Ra MΩ		
	WE350A	274 130 000 0000	80	254 130 000	A1	6.3	4.5	400	250	83	6.5	UX5	P
	WE377	02X 190 310 0000	00	029 180 310		117				60		AO8	RR
	WE403A	412 387 100 0000	00	412 365 100		6.3	2.3	150	150	7	4.3	B7G	P
	WHTS	957 231 800 0000	50	745 231 600	G1	13	1	150			0.6	B7	TH
	WHTS	957 231 800 0000	50	745 231 600	G1	13	1	250	75		1.5	B7	TH
	WT210-0006	02X 190 310 0000	00	029 180 310		6.3						AO8	DD
	WT210-0007	028 740 310 0000	00	026 540 310		6.3	18	350	250	54	5.2	AO8	P
	WT210-0012	2X9 300 000 0000	00	298 300 000		5				60		UX4	RR
	WT210-0013	29X 300 000 0000	00	289 300 000		5				120		UX4	RR
	WT210-0019	29X 300 000 0000	00	298 300 000		5				120		UX4	RR
	WT210-0021	029 0X0 310 0000	00	028 090 310		6.3				30		AO8	RR
	WT210-0025	02X 190 310 0000	00	029 180 310		117				60		AO8	RR
	WT210-0029	028 040 310 0000	00	026 040 310		6.3	8	250		8	2	AO8	T
	WT210-0037	128 479 310 0000	00	126 458 310		117				60		AO8	RP
	WT210-0037	128 479 310 0000	00	126 458 310		117	5.2	100	100	43	5.3	AO8	RP
	WT210-0040	902 30X 100 0000	00	802 309 100		6.3				30		B7G	RR
	WT210-0042	030 90X 020 0000	00	030 809 020		5				60		AO8	RR
	WT210-0048	020 90X 030 0000	00	020 809 030		5				120		AO8	RR
	WT210-0081	021 417 380 0000	00	021 415 360		6.3	2	250	100	3	1.7	AO8	P
	WT210-0082	028 740 310 0000	00	026 540 310		6.3	12.5	250	250	45	4.1	AO8	P
	WT210-0083	218 4X9 130 0000	00	216 498 130		6.3	2	250		2.3	1.6	B8B	DDT
	WT210-0084	028 456 310 0000	00	027 446 310		6.3	5	250		3	1.6	AO8	TT
	WT210-0085	412 387 400 0000	00	412 365 400		50	7.5	150	100	49	7.5	B7G	P
	WT210-0087	028 748 310 0000	50	027 546 310	G1	6.3	1	100		8	2.5	AO8	TH
	WT210-0087	028 748 310 0000	50	027 546 310	G1	6.3	3	250	100	4	1.2	AO8	TH
	WT210-0089	028 740 310 0000	00	026 540 310		6.3	9	200	175	15	2.3	AO8	P
	WT210-0090	287 113 000 0000	40	265 113 000	G1	6.3	3	250	100	2	1.2	UX6	P
	WT210-0094	481 581 230 0000	00	461 471 230		6.3	8	250		9	2.6	AO8	TT
	WT210-0108	481 581 230 0000	00	461 471 230		6.3	31.5	150		100	9	AO8	TT
	WT210-0148	02X 090 310 0000	00	029 080 310		6.3				60		AO8	RR
	WT389	038 740 320 0000	00	036 540 320		1.4	4.6	90	90	8	2	AO8	P
	WT389	038 740 320 0000	00	036 540 320		1.4	8	250		8	2	AO8	P
	WT390	028 040 310 0000	00	026 040 310		6.3		150		5.5		AO8	T
	WT-T102	020 90X 030 0000	00	020 809 030		5				60		AO8	RR

SPEC.	VALVE TYPE NUMBER	PIN CONNECTIONS				CHARACTERISTICS						BASE	VALVE CLASS
		VCM163 Tester Only		CT160, VT160, VCM Mk 1,2,3,4		Vh	Vg1	Va	Vg2	la	gm mA/V		
		SELECTOR SWITCH	TOP CAP	SELECTOR SWITCH	TOP CAP	V	V	V	V	mA	†Ra MΩ		
	WT-T122	021 417 380 0000	00	021 415 360		6.3	3	250	100	3	1.6	AO8	P
	WT-T123	028 740 310 0000	00	026 540 310		6.3	12.5	250	250	45	4.1	AO8	P
	WT-T124	218 4X9 130 0000	00	216 498 130		6.3	2	250		2.3	1.6	B8B	DDT
	WT-T125	028 458 310 0000	00	027 446 310		6.3	5	250		3	1.6	AO8	TT
	WT-T126	412 387 400 0000	00	412 365 400		50	7.5	150	100	49	7.5	B7G	P
	WT-T128	020 048 310 0000	50	027 546 310	G1	6.3	1	100		8	2.5	AO8	TH
	WT-T128	028 700 310 0000	50	027 546 310	G1	6.3	3	250	100	4	1.2	AO8	TH
	WT-T130	028 740 310 0000	00	026 540 310		6.3	9	200	175	15	2.3	AO8	P
	WT-T131	287 113 000 0000	40	265 113 000	G1	6.3	3	250	100	2	1.2	UX6	P
	WT-T135	020 90X 030 0000	00	020 809 030		5				120		AO8	RR
	X14	028 748 300 0000	40	026 546 300	G1	1.4		90	50	1.8	0.5	AO8	H
	X17	288 424 300 0000	00	266 424 300		1.4	4	75		4.5	1.2	B7G	H
	X18	288 484 300 0000	00	266 464 300		1.4	4	75		4	1.2	B7G	H
	X21	847 230 800 0000	40	645 230 600	G1	2		150	75			B7	H
	X22	847 320 800 0000	40	645 320 600	G1	2		150	75			B7	H
	X23	841 230 800 0000	50	645 231 700	G1	2		100		2.1		B7	TH
	X23	051 230 800 0000	50	645 231 700	G1	2	1.5	150	60	0.7		B7	TH
	X24	841 230 800 0000	50	645 231 700	G1	2		100		2.1		B7	TH
	X24	251 230 800 0000	50	645 231 700	G1	2	1.5	150	60	0.7		B7	TH
	X30	847 231 800 0000	40	645 231 600	G1	13	3	150	75	7		B7	H
	X31	841 231 800 0000	50	645 231 700	G1	13		150		2.2		B7	TH
	X31	051 231 800 0000	50	645 231 700	G1	13		250	75	2.3		B7	TH
	X41	841 231 800 0000	50	645 231 700	G1	4	6	150		5	1.4	B7	TH
	X41	051 231 800 0000	50	645 231 700	G1	4	3	250	75	2.3	1.4	B7	TH
	X42	842 231 800 0000	40	642 231 600	G1	4	3	250	100	7	2	B7	H
	X61	028 748 310 0000	50	027 546 310	G1	6.3	2	100		5.4	2.2	AO8	TH
	X61	028 750 310 0000	50	027 546 310	G1	6.3	2	250	100	3	0.7	AO8	TH
	X61M	028 748 310 0000	50	027 546 310		6.3	2	100		7.5	2.5	AO8	TH
	X61M	028 750 310 0000	50	027 546 310		6.3	2	250	100	8	2.6	AO8	TH
	X63	028 747 310 0000	40	026 545 310	G1	6.3	3	250	100	6	1.6	AO8	H
	X64	028 740 310 0000	40	026 540 310	G1	6.3	3	250	100	5.3	1.1	AO8	H
	X65	028 748 310 0000	50	027 546 310	G1	6.3	1	100		8	2.5	AO8	TH
	X65	028 750 310 0000	50	027 546 310	G1	6.3	3	250	100	4	1.2	AO8	TH
	X66	028 748 310 0000	50	027 546 310	G1	6.3	1	100		8	2.5	AO8	TH
	X66	028 750 310 0000	50	027 546 310	G1	6.3	3	250	100	4	1.2	AO8	TH
	X71	028 748 310 0000	50	027 546 310	G1	15		100				AO8	TH
	X71	028 750 310 0000	50	027 546 310	G1	15	3	250	100			AO8	TH
	X73	028 748 310 0000	40	026 546 310	G1	6.3	3	150	75			AO8	H
	X75	028 748 310 0000	40	026 546 310	G1	15		150	75			AO8	H
	X76	028 748 310 0000	50	027 546 310	G1	13	1	100		8	2.5	AO8	TH
	X76	028 750 310 0000	50	027 546 310	G1	13	3	250	100	4	1.2	AO8	TH
	X77	412 388 100 0000	00	412 366 100		6.3	2	100		12	6.5	B7G	H
	X78	752 388 400 0000	00	542 376 400		6.3	2	100		5	2.2	B7G	TH
	X78	752 380 500 0000	00	542 376 400		6.3	1	150	75	5.3	2.2	B7G	TH
	X79	751 238 480 0000	00	541 237 46*		6.3	2	100		5	2.2	B9A	TH
	X79	751 238 500 0000	00	541 237 46*		6.3	3	250	75	10	3	B9A	TH
	X81	288 475 130 0000	00	265 454 130		6.3	1	100		4.8	1.4	B8B	TH
	X81	280 575 130 0000	00	265 454 130		6.3	2	250	100	4	2	B8B	TH
	X99	284 300 000 0000	00	264 300 000		3	4.5	90		2.5	0.4	UX4	T
	X101	288 475 130 0000	50	276 454 130	G1	19	2	100		3		B8B	TH
	X101	280 575 130 0000	50	276 454 130	G1	19		250	100	3		B8B	TH
	X107	412 387 400 0000	00	412 365 400		19		100	250	4		B7G	O

SPEC.	VALVE TYPE NUMBER	PIN CONNECTIONS				CHARACTERISTICS						BASE	VALVE CLASS
		VCM163 Tester Only		CT160, VT160, VCM Mk 1,2,3,4		Vh	Vg1	Va	Vg2	la	gm mA/V		
		SELECTOR SWITCH	TOP CAP	SELECTOR SWITCH	TOP CAP	V	V	V	V	mA	†Ra MΩ		
X108	752 388 400 0000	00		542 376 400		19	2	100		5	2.2	B7G	TH
X108	752 380 500 0000	00		542 376 400		19	1	250	75	5.3	2.2	B7G	TH
X109	751 238 480 0000	00		541 237 46*		19	2	100		5	2.2	B9A	TH
X109	751 238 500 0000	00		541 237 46*		19	3	250	75	2.9		B9A	TH
X118	288 475 130 0000	00		276 454 130		28		100		5	4	B9A	TH
X118	280 575 130 0000	00		276 454 130		28	2.5	200	100	3	2.5	B9A	TH
X119	751 238 184 0000	00		541 237 164		19	1	100		13.5	3.7	B9A	TP
X119	751 238 184 0000	00		541 237 164		19	2.2	200	100		2.3	B9A	TP
X142	288 475 130 0000	00		276 454 130		14	2	100		5	2	B8A	TH
X142	280 575 130 0000	00		276 454 130		14	2	200	75	8	2.2	B8A	TH
X143	288 475 130 0000	00		276 454 131		6.3	2	100		6.3	2.4	B8B	TH
X143	280 575 130 0000	00		276 454 131		6.3	2	250	90	5.3	2.2	B8B	TH
X145	288 475 130 0000	00		276 545 130		28	3.3	100		6	2	B8A	TH
X145	280 575 130 0000	00		276 545 130		28	2.5	200	100	8	2.5	B8A	TH
X147	028 748 310 0000	50		027 546 310	G1	6.3	2	100		5.4	2.2	AO8	TH
X147	028 750 310 0000	50		027 546 310	G1	6.3	2	250	100	5	2.4	AO8	TH
X148	288 475 130 0000	00		276 454 130		6.3	1	100		4.8	1.4	B8B	TH
X148	280 575 130 0000	00		276 454 130		6.3	2	250	100	4	2	B8B	TH
X150	288 475 130 0000	00		276 454 130		6.3	2	100		5	2.6	B8A	TH
X150	280 575 130 0000	00		276 454 130		6.3	2	250	100	8	2.2	B8A	TH
X719	751 238 084 0000	00		541 237 164		6.3	3	100		5	2.3	B9A	TH
X719	751 238 084 0000	00		541 237 164		6.3	2	250	100	6.5	2.3	B9A	TH
X727	412 388 100 0000	00		412 366 100		6.3	2	100		11	7	B7G	H
X6030	020 990 330 0000	00		020 880 330		3						B8B	D
XC88	414 234 484 0000	00		414 234 464		2		150		12.5	14	B9A	T
XC95	142 380 100 0000	00		142 360 100		1.8	1.2	200		10	10.5	B7G	T
XCC82	841 228 513 0000	00		641 227 413		6.3	0	100		11.8	3.1	B9A	TT
XCC89	148 235 118 0000	00		146 234 117		3.6	1.2	100		15	12	B9A	TT
XCC189	851 238 410 0000	00		741 236 410		4.5	1.2	90		15	12.5	B9A	TT
XCF80	857 238 114 0000	00		645 237 114		4.5	2	100		14	5	B9A	TP
XCF80	857 238 114 0000	00		645 237 114		4.5		200	150	10	6.2	B9A	TP
XCF82	857 238 114 0000	00		645 237 114		4.8	1	150		18	8.5	B9A	TP
XCF82	857 238 114 0000	00		645 237 114		4.8		200	100	10	5.2	B9A	TP
XCL82	415 238 718 0000	00		414 237 516		8	0	100		3.5	2.5	B9A	TP
XCL82	415 238 718 0000	00		414 237 516		8		200	150	41	7.5	B9A	TP
XCL84	481 238 157 0000	00		461 237 145		7.8	1.7	200		3	4	B9A	TP
XCL84	481 238 157 0000	00		461 237 145		7.8	2.9	200	200	18	10.4	B9A	TP
XCL85	841 238 715 0000	00		641 237 514		8.6	08	100		5	6.5	B9A	TP
XCL85	841 238 715 0000	00		641 237 514		8.6		200	150	41	7.5	B9A	TP
XCL86	417 238 158 0000	00		415 237 146		7.5	1.7	250		1.2	16	B9A	TP
XCL86	417 238 158 0000	00		415 237 146		7.5	7	250	250	36	10	B9A	TP
XD	842 300 000 0000	00		642 300 000		2	1.5	75		0.7	0.8	SM4	T
XD1.5V	842 300 000 0000	00		642 300 000		1.5		50		0.4	0.4	SM4	T
XD2.0V	842 300 000 0000	00		642 300 000		2	1	60		0.5	0.6	SM4	T
XE2	823 000 000 0000	00		623 000 000		1.25	2.9	12		0.1	0.1	B3G	T
XE4	823 000 000 0000	00		623 000 000		1.25	2	12		0.23	0.12	B3G	T
XF80	141 230 871 0000	00		141 230 651		3.4	2	200	175	10	7.2	B9A	P
XF85	141 230 871 0000	00		141 230 651		3.4	2	250	100	10	6	B9A	P
XF86	701 238 014 0000	00		501 236 014		2.5	2	250	150	3	2.3	B9A	P
XF94	412 387 100 0000	00		412 365 100		3.1	1.0	250	150	10.8	5.2	B7G	P
XF183	141 230 871 0000	00		141 230 651		3.6	2	200	90	12	12.5	B9A	P
XF184	141 230 871 0000	00		141 230 651		3.6	2.5	200	200	10	15	B9A	P
XFG1	824 300 000 0000	00		624 300 000		1.5		40		1.5		B5A	T

SPEC.	VALVE TYPE NUMBER	PIN CONNECTIONS				CHARACTERISTICS						BASE	VALVE CLASS
		VCM163 Tester Only		CT160, VT160, VCM Mk 1,2,3,4		Vh	Vg1	Va	Vg2	Ia	gm mA/V		
		SELECTOR SWITCH	TOP CAP	SELECTOR SWITCH	TOP CAP	V	V	V	V	mA	†Ra MΩ		
	XFR1	872 430 000 0000	00	652 430 000		1.2		40	40	3	2	B5A	P
	XFR2	872 430 000 0000	00	652 430 000		1.2		60	60	1.8	1.9	B5A	P
	XFR3	824 300 000 0000	00	624 300 000		1.2	5	150		4	1.7	B5	T
	XFR5	872 430 000 0000	00	652 430 000		1.2		60	60	1.8	1.1	B5A	P
	XFW10	873 420 000 0000	00	653 420 000		0.6		20	20			B5A	P
	XFW20	872 430 000 0000	00	652 430 000		0.6		20	20			B5A	P
	XFW30	873 420 000 0000	00	653 420 000		0.6		20	20			B5A	P
	XFW40	873 420 000 0000	00	653 420 000		0.6		20	20			B5A	P
	XFW50	873 420 000 0000	00	653 420 000		0.6		20	20			B5A	P
	XFY10	873 420 000 0000	00	653 420 000		1.3	1.3	20	20	0.5	0.4	B5A	P
	XFY11	873 420 000 0000	00	653 420 000		1.2		20	20	0.3	0.4	B5A	P
	XFY12	873 420 000 0000	00	653 420 000		1.2	0.5	20	20	0.3	0.4	B5A	P
	XFY14	873 420 000 0000	00	653 420 000		1.2	6.5	60	60	3.1	0.6	B5A	P
	XFY15	873 420 000 0000	00	653 420 000		1.2	6.5	60	60	3	0.6	B5A	P
	XFY20	873 420 000 0000	00	653 420 000		0.6		20	20			B5A	P
	XFY21	873 420 000 0000	00	653 420 000		1.2		20	20	0.4	0.4	B5A	P
	XFY22	873 420 000 0000	00	653 420 000		1.2	1.2	20	20	0.3	0.4	B5A	P
	XFY23	873 420 000 0000	00	653 420 000		1.2	2	20	20	0.4	0.3	B5A	P
	XFY31	873 420 000 0000	00	653 420 000		1.2		20	20	0.4	0.4	B5A	P
	XFY32	873 420 000 0000	00	653 420 000		1.2	1.5	20	20	0.4	0.3	B5A	P
	XFY33	873 420 000 0000	00	653 420 000		1.2	2	20	20	0.4	0.3	B5A	P
	XFY34	873 420 000 0000	00	653 420 000		1.2	4	40	40	1.5	0.6	B5A	P
	XFY35	873 420 000 0000	00	653 420 000		1.2	1.5	40	40	0.7	0.6	B5A	P
	XFY41	873 420 000 0000	00	653 420 000		1.2	1.2	40	30	0.3	0.4	B5A	P
	XFY43	873 420 000 0000	00	653 420 000		1.2	2	20	20	0.4	0.3	B5A	P
	XFY51	873 420 000 0000	00	653 420 000		1.2		20	20	0.2	0.3	B5A	P
	XFY53	873 420 000 0000	00	653 420 000		1.2	3	20	20	0.5	0.3	B5A	P
	XFY53M	873 420 000 0000	00	653 420 000		1.2	3	20	20	0.5	0.3	B5A	P
	XFY54	873 420 000 0000	00	653 420 000		1.2	2	20	20	0.3	0.3	B5A	P
	XH2.0V	842 300 000 0000	00	642 300 000		2	1	60		0.5	0.6	SM4	T
	XHP1.5V	284 830 000 0000	50	264 730 000	G1	1.5	4.5	50		1.7	0.7	SM5	TT
	XHP1.5V	284 830 000 0000	50	264 730 000	G1	1.5	0	50		0.5	0.5	SM5	TT
	XL	842 300 000 0000	00	642 300 000		2	1.5	75		1.5	0.9	SM4	T
	XL01.5	842 300 000 0000	00	642 300 000		1.5	1	60		0.9	0.7	SM4	T
	XL01.5V	041 230 807 0000	00	*41 23* 6*5		8	7.3	250	250	48	11.3	B9A	P
	XL1.5	842 300 000 0000	00	642 300 000		1.5	1	60		0.7	0.6	SM4	T
	XL2.0V	842 300 000 0000	00	642 300 000		2	1	60		1	0.8	SM4	T
	XL36	842 300 000 0000	00	642 300 000		1.5	4.5	50		1.7	0.7	SM4	T
	XL84	802 384 100 0000	00	6*2 364 100		2	1	50		1.1	0.9	B7G	T
	XL86	020 740 310 0000	80	*2* 540 310	A1	12.8	8.3	100	100	77	11	AO8	P
	XP	842 300 000 0000	00	642 300 000		2	4.5	100		9.5	1	SM4	T
	XP1.5V	842 300 000 0000	00	642 300 000		1.5	4	60		1.8	0.8	SM4	T
	XP2	842 300 000 0000	00	642 300 000		2	4.5	75		4	1	SM4	T
	XPH1.5	284 930 000 0000	50	264 730 000	G1	1.5	4.5	50		1.7	0.7	SM5	TT
	XPH1.5	284 930 000 0000	50	264 730 000	G1	1.5	0	50		0.5	0.5	SM5	TT
	XR2	208 037 240 0000	00	206 035 240		1.2	7.5	150	125	7	1.9	B8D	P
	XR4	208 037 240 0000	00	206 035 240		1.2	7.5	150	125	7	1.9	B8D	P
	XR6	412 183 710 0000	00	412 163 510		6.3	1.4	100	100	7	5	B8D	P
	XR7	412 873 180 0000	00	412 653 160		6.3	2	100	100	7.5	5.5	B8D	P
	XR8	482 803 180 0000	00	462 603 160		6.3	2.5	100		8	4.2	B8D	T

SPEC.	VALVE TYPE NUMBER	PIN CONNECTIONS				CHARACTERISTICS						BASE	VALVE CLASS
		VCM163 Tester Only		CT160, VT160, VCM Mk 1,2,3,4		Vh	Vg1	Va	Vg2	la	gm mA/V		
		SELECTOR SWITCH	TOP CAP	SELECTOR SWITCH	TOP CAP	V	V	V	V	mA	†Ra MΩ		
	XR9	852 113 480 0000	00	742 113 460		6.3	1.8	100		8.5	5	B8B	TT
	XSG	742 300 000 0000	80	542 300 000	A1	2	1	150	60	1.4	0.7	Sm4	P
	XSG1.5V	742 300 000 0000	80	542 300 000	A1	1.5	0	50	30	0.5	0.3	Sm4	P
	XSG2.0V	742 300 000 0000	80	542 300 000	A1	2	0	60	30	0.6	0.4	Sm4	P
	XVS2.0V	742 300 000 0000	80	542 300 000	A1	2	0	60	30	0.4	0.3	Sm4	P
	XW1.5	274 830 000 0000	00	254 630 000		1.5	0	60	30	0.7	0.5	Sm5	P
	XW1.5	271 830 000 0000	40	251 630 000	G1	1.5	0	50	50	0.7	0.5	Sm5	P
	XW2.0V	274 830 000 0000	00	254 630 000		2	0	60	50	0.9	0.6	Sm5	P
	XW075A	873 420 000 0000	00	653 420 000		0.6		40	30	0.3	0.2	B5A	P
	XW075B	873 420 000 0000	00	653 420 000		0.6		40	30	0.2	0.2	B5A	P
	XXB	208 458 320 0000	00	206 447 320		1.4		90		4.5	1.3	B8B	TT
	XXD	218 458 130 0000	00	216 447 130		12.5	10	250		9	2.1	B8B	TT
	XXFM	284 19X 130 0000	00	264 189 130		6.3	2	250		1.5	1.5	B8B	DDT
	XXL	280 004 130 0000	00	260 004 130		6.3	8	250		8	2.3	B8B	T
	XY	274 830 000 0000	00	254 630 000		2	3	75	75	4	1.2	SM5	P
	XY1.4A	873 420 000 0000	00	653 420 000		1.4	4.5	40	40	1.8	0.5	B5A	P
	XY1.4B	873 420 000 0000	00	653 420 000		1.2	4.5	40	40	1.6	0.6	B5A	P
	XY1.4C	873 420 000 0000	00	653 420 000		1.2	1.5	40	40	0.5	0.5	B5A	P
	XY1.5	274 830 000 0000	00	254 630 000		1.5	1.5	40	40	1.7	1	SM5	P
	XY2.0V	248 730 000 0000	00	246 530 000		2	2	60	50	1.7	1.4	SM5	P
	XY14B	873 420 000 0000	00	653 420 000		1.2	4.5	40	40	0.3	0.6	B5A	P
	XY14CC	873 420 000 0000	00	653 420 000		1.2	1.5	40	40	0.5	0.5	B5A	P
	XY88	000 230 009 0000	10	*** 23* **8	C	16				120		B9A	R
	Y13	047 231 800 0000	00	045 231 600		13	20	250	250	40	3.9	B7	P
	Y25	400 230 080 0000	00	4*0 320 060		1.4	34	250		0.09	†2.2	B8A	TI
	Y61	028 740 310 0000	00	026 540 310		6.3	22	250	250	0.2	†1.0	AO8	TI
	Y62	028 740 310 0000	00	026 540 310		6.3	22	250	250		†1.0	AO8	TI
	Y63	028 740 310 0000	00	026 540 310		6.3	22	250	250	0.2	†1.0	AO8	TI
	Y64	028 740 310 0000	00	026 540 310		6.3	22	250	250		†1.0	AO8	TI
	Y65	028 740 310 0000	00	026 540 310		6.3	11	250	250		†1.0	AO8	TI
	Y119	410 270 807 0000	00	41* 25* 6*5		19	14	200	200	0.4	†0.5	B9A	-
	Y220	842 300 000 0000	70	642 300 000	G2	2	4.5	150	150	10.5	2.5	B4	P
	Y220	842 370 000 0000	00	642 350 000		2	4.5	150	150	10.5	2.5	B5	P
	Y230	842 370 000 0000	00	642 350 000		2	3	150	150	5		B5	P
	YA1000	230 232 032 0000	80	230 232 032	A1	4				180		B9A	R
	YC88	414 234 484 0000	00	414 234 464		2.6		160		12.5	14	B9A	T
	YC95	142 380 100 0000	00	142 360 100		2.2	1.2	200		10	10.5	B7G	T
	YCC89	148 235 118 0000	00	146 234 117		4.8	1.9	100		15	12	B9A	TT
	YCL82	415 238 718 0000	00	414 237 516		10.8	0	100		3.5	2.5	B9A	TP
	YCL82	415 238 718 0000	00	414 237 516		10.8		200	150	41	7.5	B9A	TP
	YCL84	481 238 157 0000	00	461 237 145		10	1.7	200		3	4	B9A	TP
	YCL84	481 238 157 0000	00	461 237 145		10		200	150	18	11	B9A	TP
	YCL86	417 238 158 0000	00	415 237 146		10	1.7	250		1.2	1.6	B9A	TP
	YCL86	417 238 158 0000	00	415 237 146		10	7	250	250	36	10	B9A	TP
	YD2	842 300 000 0000	00	642 300 000		2	4.5	150		6	3	B4	T
	YF183	141 230 871 0000	00	141 230 651		4.2	2	200	100	12	12.5	B9A	P
	YF184	141 230 871 0000	00	141 230 651		4.2	2.5	200	200	10	15	B9A	P
	YL84	041 230 807 0000	00	*41 23* 6*5		8	7.3	250	250	48	11.3	B9A	P
	YL86	041 230 807 0000	00	041 23* 6*5		8	12.5	200	200	75	10	B9A	P
	YL1000	014 237 188 0000	00	014 235 166		1.1	6.5	100	100	30	4.3	B9A	P
	YL1020	247 105 200 0000	88	245 1*4 200	A1/A2	1.6		300	250	40	4	B7A	PP

SPEC.	VALVE TYPE NUMBER	PIN CONNECTIONS				CHARACTERISTICS						BASE	VALVE CLASS
		VCM163 Tester Only		CT160, VT160, VCM Mk 1,2,3,4		Vh	Vg1	Va	Vg2	la	gm mA/V		
		SELECTOR SWITCH	TOP CAP	SELECTOR SWITCH	TOP CAP	V	V	V	V	mA	†Ra MΩ		
	YL1030	247 305 200 0000	88	245 3*4 200	A1/A2	2.1		200	200	30	4.5	B7A	PP
	YL1060	247 135 200 0000	88	245 134 200	A1/A2	6.3	15	300	250	95	5	B7A	PP
	YL1080	425 238 782 0000	00	424 236 572		1.6		200	200	30	3.3	B9A	PP
	YL1130	423 878 324 0000	00	423 756 324		1.1		200	200	40	7	B9A	PP
	YL1150	701 423 100 0000	80	245 611 300		6.3		400	250	100	35	B7A	P
	YL1190	431 878 235 0000	00	432 756 234		1.5		150	150	45	9.5	B9D	PP
	YL1200	247 811 300 0000	00	245 611 300		12.6	17	100	250	100		B7A	P
	YL1240	415 228 783 0000	00	414 227 563		6.75		400	200	30	3.3	B9A	PP
	YY88	000 230 009 0000	10	*** 23* **8	C	22				180		B9A	R
	Z14	038 700 200 0000	40	036 500 200	G1	1.4	1	100	100	0.5	0.6	AO8	P
	Z21	742 300 000 0000	80	041 230 500	A1	2	1	150	150	1.1	1.2	B7	P
	Z21	041 230 700 0000	80	542 300 000	A1	2	1	150	150	1.1	1.2	B4	P
	Z22	041 230 700 0000	80	041 230 500	A1	2	0	150	150	2.5	1.4	B7	P
	Z22Met	041 230 700 0000	80	041 230 500	A1	2	0	150	150	2.5	1.4	B7	P
	Z26	047 231 800 0000	00	045 231 600		26	5.5	250	250	32	7.5	B7	P
	Z62	028 710 310 0000	40	026 510 310	G1	6.3	2	300	150	10	7.5	AO8	P
	Z63	028 710 310 0000	40	026 510 310	G1	6.3	3	250	100	2	1.2	AO8	P
	Z66	028 710 310 0000	40	026 510 310	G1	6.3	1.5	200	200	10.9	8.5	AO8	P
	Z73	028 710 310 0000	40	026 510 310	G1	6.3	3	250	100	6.5	1.7	AO8	P
	Z77	412 381 700 0000	00	412 361 500		6.3	2	250	250	10	7.5	B7G	P
	Z77	412 381 700 0000	00	412 361 500		6.3	1.5	200	150	4	6.4	B7G	P
	Z90	278 101 403 0000	00	256 101 403		6.3	2	250	250	10	6	B9G	P
	Z142	280 174 130 0000	00	260 154 130		21	2	200	200	10	8.5	B8A	P
	Z145	281 714 130 0000	00	261 514 130		22	1.8	200	200	10	9	B8A	P
	Z150	280 174 130 0000	00	260 154 130		6.3	2	250	250	10	9.5	B8A	P
	Z152	141 230 871 0000	00	141 230 651		6.3	2	200	200	10	7.4	B9A	P
	Z220	842 370 000 0000	00	642 350 000		2	7.5	150	150	15	2	B4	P
	Z220	842 300 000 0000	70	642 300 000	G2	2	7.5	150	150	15	2	B5	P
	Z309	141 223 871 0000	00	141 223 651		6.3	2	250	250	20	15	B9A	P
	Z319	141 231 877 0000	00	141 321 655		6.3	2	350	250	12.5	11.5	B9A	P
	Z329	141 230 871 0000	00	141 230 651		7.3	1.9	200	175	10	8.8	B9A	P
	Z359	141 230 871 0000	00	141 230 651		12	2	250	250	20	15	B9A	P
	Z719	141 230 871 0000	00	141 230 651		6.3	2	200	175	10	7.4	B9A	P
	Z729	701 238 014 0000	00	501 236 014		6.3	1	250	100	2	1.8	B9A	P
	Z749	141 230 871 0000	00	141 230 651		6.3	1.9	200	175	10	9.2	B9A	P
	Z759	141 023 871 0000	00	141 023 651		6.3	2	250	250	15	15	B9A	P
	ZD	9X2 310 000 0000	00	892 310 000		13						B5	DD
	ZD2	842 300 000 0000	00	642 300 000		2	12	150		7	1	B4	T
	ZD17	209 784 300 0000	00	208 564 300		1.4	1	90	90	2.7	0.6	B7G	DP
	ZD25	209 784 300 0000	00	2*8 564 300		1.4	1.5	60	60	0.2	0.2	B7G	DP
	ZD152	741 238 9X1 0000	00	541 236 891		6.3	2	250	90	5	2.2	B9A	DDP

## APPENDIX I

## TEST DATA FOR HIGH VOLTAGE RECTIFIERS

The following procedure should be adopted when testing high voltage rectifiers.

Make insulation checks with valve cold end hot as stated in paragraphs 1 and 2 of the Abbreviated Working Instructions.

Then set Anode and Screen Voltage switches to their minimum value (i.e. 20) and Anode Current Controls to figure shown in Data column. With circuit Selector set to TEST and Anode Selector at A1 increase Anode Volts setting until indicating meter reads in a forward direction.

The setting of the Anode Voltage switch for a good valve should not exceed the figure given in column headed Anode Volts.

When checking full wave or voltage doubler rectifiers, check second Anode with Anode Selector at A2.

NOTE:— The valve should be heated to working temperature before setting Circuit Selector to position TEST and only left at this position for sufficient time to take a reading.

VALVE	SELECTOR SWITCH	TOP CAP	SELECTOR SWITCH	TOP CAP	Vf	Anode Volts (Max.)	Ia mA (Min.)	Valve Holder	Type	Remarks
	VCM 163 only		VCM.s Mk 1-4 incl							
†1B3	020 000 300 0000	80	020 000 300	A1	1.25	200	6	A08	R	
†1Z2	232 232 300 0000	80	232 232 300	A1	1.4			B7G	R	
†2V3	020 000 300 0000	80	020 000 300	A1	2.5(3)			A08	R	
†2V3G	020 000 300 0000	80	020 000 300	A1	2.5(3)			A08	R	
†2X2	200 300 000 0000	80	200 300 000	A1	2.5(3)	100	10	UX4	R	
†2Y2	200 300 000 0000	80	200 300 000	A1	2.5	100	10	UX4	R	
†3B24	320 200 000 0000	80	320 200 000	A1	2.5	60	10	UX4	R	
†6W2	230 000 000 0000	80	230 000 000	A1	6.3	100	9	Nil	R	
†225DU	002 323 800 0000	00	082 323 600		2	40	20	B7	RR	Test A1 & A2
†225DU	082 323 000 0000	00	082 323 600		2	40	20	B7	RR	Test A1 & A2
†405BU	082 300 000 0000	00	672 300 000		4	40	20	84	RR	Test A1 & A2
†405BU	802 300 000 0000	00	672 300 000		4	40	20	84	RR	Test A1 & A2
†732A	230 300 000 0000	80	230 300 000	A1	2.5	60	10	UX4	R	
†879	200 300 000 0000	80	200 300 000	A1	2.5	100	10	UX4	R	
†1876	123 000 800 0000	00	123 000 700		4			8SC	R	
†1877	002 300 000 0000	80	002 300 000	A1	4	100	10	B4	R	
†8016	020 000 300 0000	80	020 000 300	A1	1.25	200	6	A08	R	
†8020	200 300 000 0000	80	200 300 000	A1	5	100	22	B4	R	
†CE230	320 200 000 0000	80	320 200 000	A1	2.5	60	10	UX4	R	
†EY51	230 000 000 0000	80	230 000 000	A1	6.3	100	9	83G	R	
†HVR2	002 300 000 0000	80	002 300 000	A1	4	100	10	B4	R	
†HVR2A	002 300 000 0000	80	002 300 000	A1	2(2.5)	100	10	B4	R	
†R12	230 000 000 0000	80	230 000 000	A1	6.3	100	9	B3G	R	
†SU61	230 000 000 0000	80	230 000 000	A1	6.3	100	9	B3G	R	
†SU2150	002 300 000 0000	80	002 300 000	A1	2(2.5)	60	4	B4	R	
†SU2150A	002 300 000 0000	80	002 300 000	A1	2	200	50	B4	R	
†U17	002 300 000 0000	80	002 300 000	A1	4	40	35	B4	R	
†U19	002 300 000 0000	80	002 300 000	A1	4(5)	40	70	B4	R	
†U21	002 300 000 0000	80	002 300 000	A1	2	60	4	B4	R	
†U22	200 000 030 0000	80	200 000 030	A1	2(3)	60	4	M08	R	
†U23	002 300 000 0000	80	002 300 000	A1	4(5)	40	100	B4	R	
†U24	020 000 300 0000	80	020 000 300	A1	2	20	0.5	A08	R	
†U41	020 300 000 0000	80	020 300 000	A1	1.25	200	6	A08	R	
†U43	230 000 000 0000	80	230 000 000	A1	6.3	100	9	Nil	R	
†U151	230 000 000 0000	80	230 000 000	A1	6.3	100	9	Nil	R	
†V21/7000	002 300 000 0000	80	002 300 000	A1	4	100	10	B4	R	
†V960	002 300 000 0000	80	002 300 000	A1	4	80	90	B4	R	
†V1906	002 300 000 0000	80	002 300 000	A1	4(5)	60	100	84	R	
†V1907	002 300 000 0000	80	002 300 000	A1	4	150	70	84	R	
†V1913	002 300 000 0000	80	002 300 000	A1	4(5)	40	100	B4	R	
†V1920	002 300 000 0000	80	002 300 000	A1	4(5)	100	90	B4	R	
†VL51	002 300 000 0000	80	002 300 000	A1	4	100	10	B4	R	
†CV317	322 322 222 0000	80	322 322 222	A1	4	60	80	B9G	R	
†CV121	002 300 000 0000	80	002 300 000	A1	4(5)	100	90	B4	R	

**INTENTIONALLY LEFT BLANK**



## APPENDIX II

## TEST DATA FOR 'SERVICE' TYPE VALVES

## NOTES REFERRED TO IN THE REMARKS COLUMN

- A The heater/cathode lead identified with red marking should be connected to Pin No. 1.  
 B The grid top cap is situated over Pins No. 7 and 8.  
 C This valve does not fit special valve holders supplied, and roller selector Data will depend on connections made to valve electrodes.  
 D Pin No. 1 on the flat pinch type of base is the lead adjacent to the coloured blob the remaining pins being directly numbered across the base from Pin No. 1.  
 E Alternative test figures are given for use when the value shows signs of back emission from anode to G3. This phenomenon can be recognised by the anode current apparently decreasing as the valve heats.  
 G Valves on the B8D base when leads are cut, should be tested either by insertion in a B8D Adaptor, or leads lengthened and tested in the same way as those with flexible leads, by using the special 9 clip valve holder.  
 H Tests on tuning indicators should not be made until the resistor value (Ra), indicated in the remarks column, has been inserted across the link(s) on valve panel.  
 J Use special 9 clip valve holder fitted to Valve Tester type 160.

VALVE	SELECTOR TOP SWITCH CAP VCM 163 only	Vf	Neg. Grid Volts	Anode Volts	Screen Volts	Ia mA	mAV	Base	Type	Remarks	
CV16	234 000 000	A1	4	1	250	6	4.2	Disc seal	T	Min slope	
CV53	234 000 000	A1	4	1	250	6	4.2	Disc seal	T	See Note A Min slope See Note A	
CV82	234 000 000	A1	4	3	250	20	3.7	Disc seal	T	See Note A slope	
CV88	See Note C		6.3	0	250	4	5	Disc seal	T	Min Slope See Note C	
CV93	See Note C		1.4	0	20		0.7	Disc seal	T	See Note C	
CV105	020 000 030	D1	6.3			30		A08	R		
CV122	632 400 000		1.4	0	100		0.8	Special	T	See Note D	
CV132	412 361 500		6.3	1.8	250	100	6.3	B7G	H		
CV201	021 540 300	A1	(2.5)	10	250	150	25	A08	P		
CV229	623 400 000		1.4	0	100		0.8	Special	T	See Note D	
CV243	042 350 000		(5)	40	75	75	45	B5	P		
CV273	346 000 000	H-	6.3	4	250		28	8.5	Disc seal	T	
CV354	346 000 000	H-	6.3	2	250		10	6.5	Disc seal	T	
CV384	642 300 000		(5)	30	400		62	7.5	B4	T	
CV1155	642 300 000		4	0	75		0.7	0.2	B4	T	
CV1223	642 300 000		(5)	30	400		62	7.5	B4	T	
CV1508	002 300 000	A1	(5)	40	100				B4	R	
CV1584	642 310 000		4	3.5	200		5.4	3.1	B5	T	
CV2000	412 361 500		6.3	2	250 200	250 150	10 4	7.5	B8D	P	See Notes J &
CV2001	412 361 500		6.3	1.5	250 200	250 150	10 4	7.5	B8D	P	See Notes J &
CV2002	412 360 500		6.3	13.5	250	250	16	2.6	Spec	P	See Note J
CV2003	412 360 500		6.3	13.5	250	250	16	2.6	Spec	P	See Note J
CV2004	192 310 800		6.3				5		Spec	RR	See Note J
CV2005	192 310 800		6.3				5		Spec	RR	See Note J
CV2007	741 226 413		6.3	8.5	250		10.5	2.2	Spec	TT	See Note J

VALVE	SELECTOR TOP SWITCH CAP VCM 163 only	Vf	Neg. Grid Volts	Anode Volts	Screen Volts	Ia mA	mA/V	Base	Type	Remarks	
CV2008	412 300 600		6.3	2.2	150		10	8	Spec	TT	See Note J
CV2009	412 314 600		6.3	1.5	250		10	8.5	Spec	T	See Note J
CV2010	762 344 100		6.3	1	100		8.5	5.6	Spec	TT	See Note J
CV2101	741 226 413		6.3	2	250		1.2	1.6	Spec	TT	See Note J
CV2013	041 230 651		6.3	4.5	250	250	40	11	Spec	P	See Note J
CV2014	601 235144		6.3	7.5	250	250	45	7	Spec	P	See Note J
CV2015	256 101 403		6.3	7	250	250	10	6	B9G	P	See Note J
CV2016	741 226 413		6.3	2	250		10.5	5.5	Spec	TT	See Note J
CV2017	412 361 500		6.3	4	200	200	5.8	3.5	Spec	P	See Note J
CV2020	412 365 100		6.3	2	150	125	7.5	5	Spec	P	See Note J
CV2021	902 308 100		6.3				30		Spec	R	See Note J
CV2022	441 230 561		6.3	12.5	250	250	45	4.1	Spec	P	See Note J
CV2023	412 361 500		6.3	2.5	250	200	8	2.5	Spec	P	See Note J
CV2024	412 366 100		6.3	2	100		11	7	Spec	H	See Note J
CV2025	412 361 500		6.3	2	250	250	10	7.5	Spec	P	See Note J
CV2025	412 361 500		6.3	1.5	200	150	4	6.4	Spec	P	See Note J
CV2101	040 230 650		1.25	0	75	75	2	1	B8D	P	See Note J
CV2156	241 657 143		19	14	250	150	30	3.9	B9G	PP	
CV2204	346 000 000	H-	6.3	1	250		20	3	Disc seal	T	min slope
CV2207	346 000 000	H-	6.3	1	250		20	3	Disc seal	T	min slope
CV2231	*41 23* *51	A1	6.3	12.5	150	150	50	8.5	B9A	P	
CV2243	041 230 651		6.3	2	200	125	17	8.4	B9A	P	
CV2267	Not known		6.3				30		Spec	RR	See Note C
CV2268	Not known		6.3	2	250	250	10	7.5	Spec	P	See Note C
CV2277	*41 23* 651		26.5	13	100	100	90	9.5	B9A	P	
CV2838	Not known	A1/	2		60			0.3	Special	T	See Note C
CV4036	001 230 000		6.3				120		B9A(F)	R	
CV4046	241 756 143		6.3	14	150	125	30	3.9	B9G	PP	
VU508	002 300 000	A1	(5)		40		100		B4	R	

# EQUIVALENTS

## COMMERCIAL AND BRITISH SERVICE TYPES

Many of the commercial equivalents listed in the following pages will have different CV numbers, this is due to special service requirements which do not affect the radio engineer, e.g. interelectrode capacitance, bulb size, life test, etc. It should also be noted that test data given in this manual may differ between equivalent valves, due to different sets of potentials having been selected for the test.

The inclusion of any particular , CV number or equivalent in this index does not necessarily imply that it is also included in the data section.

TYPE	CV No.	EQUIVALENTS	TYPE	CV No.	EQUIVALENTS
01A	750		1B41	3550	
02DF	2260	DF64	1B49	508	
09	2725	3209	1B58	3745	
09D	1596	3209	1B63A	2826	
09J	1518	3209	1BC2		
054V		41MXP	1BY2		
0517		PL5557	1C1	782	X17, 1R5, DK91
0A/2	1832	STV150/30, 150C2, G150/4K	1C2		DK92, X18, 1AC6, X20
0A2WA	4020	M8223	1C3		X25, 1AB6, DK96
0A3	3798	VR75/30, QS75/40	1C5	1805	DL35, N14
0Z4	692		1C5G	1803	DL35, N14
0Z4A	517	1003	1C5GT	1805	DL35
1		G160/1C	1C21	762	G1502D
1A		G279/1C	1CP1	2302	DH3-91
1A3	753	DA90, 1D13	1CP11		DB3-91
1A4P	754		1CP31	2302	DH3-91
1A5G	755	DL31	1D5	764	U4020, 405UA, UR1C/S
1A6	757		1D5GP	705	1D5GT
1A7VG		0K32	1D7	765	
1AB6		DK96, 1C3, X25	1D8GT	1811	
1AC6		DK92, X18, 1C2, X20	1D13	753	DA90, 1A3
1AD2			1E3		DC80, 6375
1AD4	2237	DF62, DF652	1E5		KF35
1AD5		1W5	1E5GP	766	1E5GT
1AF4		DF96, 1F1, W25, 1AJ4	1E7	1812	
1AF5	9024	DAF96, N14	1EP1		DF96, 1AJ4, 1AF4, W25
1AH5		DAF96, 1FD1, ZD25, 1AJ5	1F1		DF96, 1AJ4, 1AF4, W25
1AJ4		DF96, W25, 1F1, 1AF4	1F2	1758	DF92, 1L4
1AJ5		ZD25, 1AH5, DAF96, W25, 1F1	1F3	785	DF91, 1T4, W17
1AM4		1T4SF	1F4	767	
1AN5		DF97	1F5	768	KL35
1AQS		1R5SF	1F6	769	
1B1P			1F7GV	770	1F7
1B3/8106	514	U41	1FD1		DAF96, ZD25, 1AH5, 1AJ5
1B3GT	1830	U41, DY30	1FD9	784	DAF91, 1S5, ZD17
1B4P	758		1FP1		DG3-12A
1B5/25S	759		1FP35		DB3-12
1B7GT	760		1G3	1817	1H4G
1B21A	3586	471A	1G5	771	
1B22	761	WE1378X	1G6G	772	
1B23	539	729A	1G6GT	773	
1B24	725		1G8	7026	ZR11
1B24A	3548		1G35	1787	4C35, XH8-100
1B26	576		1G45P	372	3C45, XH3-045
1B27	713	TRC1	1G50	2050	EN32
1B32/532A	2648	532A	1H4G	774	
1B35	369		1H5G	1818	DAC32, HD14
1B35A	3628	6038, BS412	1H5GT	1820	DAC32
1B38	3549		1K1P		
1B40	2914		1L4	1758	DF92, 1F2

TYPE	CV No.	EQUIVALENTS	TYPE	CV No.	EQUIVALENTS
1LA6	775		2B23		2A115D
1LB4	776		2B29	2666	829B, QQV07-40
1LC5	777		2B32	788	832A, QQV04-15
1LC6	778		2B35	1092	601, EA50
1LD5	779		2B36	1078	T4D
1LH4	780		2B46	3523	6146, QV06-20
1LN5	781		2B52	2789	QQV03-20A, 6252, TT20
1LN5E	781		2B94	2797	QQV06-40A, 5894, TT25
1M1	2980	Y25, 1M3, D1771, DM71	2BP1	3678	
1M3	2980	1M3, DM70, Y25	2BU2		
1N3		DM71	2C21	875	RK33, 1642, RK22
1P1		DL96, N25, 3E5, 3C4	2C22	792	
1P5	728	1T6GT	2C26	802	2C26A
1P10	484	DL92, N17, 3S4	2C26A	1759	3B/105D
1P11	2983	DL94, N19, 3V4	2C33	793	RX233, RX233A
1P21	5138	27M1, 931A	2C34	18	4074A
1P23	2680	868, 918, 913	2C39A	2516	TD1-100A, 3H151J
1P28		27M3, MS-9SY	2C40	2643	446A, 446B
1P30	1764	CE2, 71, A3	2C42	2932	TD3-12
1P31	3812	WE, 3A, 3AE	2C43	688	TD3.5-12
1P32	405	CE25, 55CG, 2530	2C45	596	38142
1Q5G	1824	DL36	2C46	2933	TD05-12
1Q22	3555		2C51	2831	
1R4	2709		2C51W	2866	
1R5	782	DK91, X17, 1C1	2C53	3559	
1S2		DY86	2CIM3A		
1S2A		DY87	2CN3B		
1S4	783	DL91	202	794	
1S5	784	DAF91, ZD17, 1FD9	2D4A	795	D41, D400, DDL4, V914
1T2		R16, U37	2D13A		DDT13S
1T4	785	DF91, W17, 1F3	2D13C	796	10D1
1T5GT	1829		2021	797	EN91, 20A3, 5727, 4G/280K
1U4	2507	DF904, 5910	2D21W	2876	M8204
1U5	3912	DAF92	2D21Wa	4018	M8204
1V	1999	6Z3	2DP1	1813	
1V2	3994		2E22	798	2P22
1V3		DCF60	2E26	3990	QV0-10
1V5		1W5, 1AD5	2E30	2517	
1W5		1V5, 1AD5	2E31		
1X2A	5032	DY80, R19	2E32		
1X2B		R19	2E35		
1Z2	2510		2E36		
2		G155	2E41		
2-25A		AZ35	2E42		
2-150D	3878	152RA	2EM5		
2A3	1831		2EN5		
2A5	1834		2G	1842	
2A6	1769		2G8	7027	2R12, 1S001
2A7	787		2G/402A	1835	3B28, ESU103, RR3-250
2A/100A		D/1	2G/472B	2518	4B32, RR3-1250
2A/115D		2B23	2G/473C	2399	GXU3, RR3-1250A
2A1001			2GU5		
2A1004			2H28	1835	3B28, RR3-250
2A1005			2H66	32	866A, RG3, 250A
2AP1	790	DG4-1, 1814P1	2J2		KY80, U26
2AP1A	790	1814P1, D64/1	2J21	2778	2J21A
2ASZA			2J21A	719	
2B4	648	885	2J22	800	
2B7	1837		2J26	1760	
2B21	597	2X2A	2J31	1807	
2B22	2931		2J32	1808	

TYPE	CV No.	EQUIVALENTS
2J33	1809	
2J34	1810	
2J36	514	
2J42	3676	JP9-7, MAG3, M503
2J42A	3997	MAG4, JP9-15, 6027
2J48	1822	
2J49	3687	JP9-50B
2J50	2793	JP9-50C
2J51	3560	JPT9-60, 2J51A
2J51A	5134	JPT9-60, 2J51
2J54	801	
2J56	2852	JP9-50
2J58	997	3092
2J121E	28	ACT9
2K25	1795	KS9-20A
2K26		KS7-85
2K28	1892	
2K33	1786	
2K41	3904	
2K48	3669	
2L2		KY50, U25
2L32		
2L34		
2P1P		
2PJ2		
2PN4A		
2S/140G	469	EA76, 6489
2S/141G	4504	7435
2S/280K	371	19G6
2S/306B	121	19H1
2S/370D	265	19E2
2S/460A		ESU112
2S/460C	2160	ESU77
2S/490C	1504	V1901
2S/550C	490	19H5
2S/570E		PSV13
2S/590E		19H12
2T/240D	277	19G3
2T/270K	261	HR2, R10, 6305
2T/350D	2180	19H4
2T/360B		19G12
2T/450E	3587	705A
2T/460C	74	ESU74
2V2A		
2V3G	804	
2V/301B		ESU101
2V/302B		ESU115
2V/360C	1446	4017B
2V/390C		2V/474C
2V/395C	2943	ESU76
2V/400A	32	886A, DQ2, ESU886, 2H66, RG3-250A
2V/401C	1446	4017B
2V/470C	1355	4049C
2V/471A	1449	872A
2V/474C		2V/390C
2V/500C	5	4049D, RG4-1250, U20/21
2V/520A		DCG6/18
2V/521		ESU107
2V/531E	1420	869B, 4078A
2V/540		ESU111, WL-869B

TYPE	CV No.	EQUIVALENTS
2V/561E		4079
2V/590E		4080A
2W/540E	1601	4222B
2W/541E		4007A
2W/542E		4222B
2X/105G	448	0A71, GEX54
2X/106G	425	0A74, GEX44
2X2	3748	2B21, 143D, 2Y2, 2X2A
2X2A	597	1K22, R612G, 879
2X2/897	3748	2X2A
2X2/8907	3748	
2XM-600M		86BA
2Y2	597	R1626, 2B21, 2X2
3/02AM	2230	965K
3-50AG	419	DET18
3A	3812	1P31, 3AE
3A3A		
3A3B		
3A4	2390	DL93
3A5	808	DCC90
3A/105B	809	
3A/107A	249	
3A/107B	1655	AR11, 425XP
3A/108A	1653	AR12, 4020A
3A/108B	1657	4020B
3A/109A	1671	4021A
3A/109B	1663	AR20, 4021B
3A/110B	1659	4022B
3A/135A	2598	264A, 426A
3A/141A	1639	4101E, 3A/141AY
3A/142A	1641	4102D, 3A/142AY
3A/144A	1694	
3A/145/J	16	525A
3A/146J	53	
3A/147J	82	
3A/148J	88	
3A/167M	5112	437A
3A/204D	24	HL41
3A/205D	1130	HL23
3AB4		PC92
3ACP1		DG7-14
3ACP2		DN7-14
3ACP7		DP7-14
3ACP11		DB7-14
3ACP11		DB7-14
3AE	3812	1P31, 3A
3AFP7		DP7-91
3AFP11		DB7-91
3AFP31	6095	DH7-91
3AJ8		XCH81
3AL5		XAA91
3ALP1	2175	DG7-5
3ALP7	5171	DP7-5
3ALP11		DB7-5
3AMP1	2431	DG7-32
3AMP1A		DG7-32/01
3AP1	602	906P1
3ARP1		DG7-74A
3AT4A		PC93
3AT2A		

TYPE	CV No.	EQUIVALENTS
3AU6		XF94
3AW2A		
3AZP2	5883	DNM9-11
3AZP7		DPM9-11
3AZP11		DBM9-11
3AZP31		DHM9-11
3B4	2240	DL98
3B7	811	
3B21	2959	3B22
3B22	3815	
3B24	812	732A, 428T, CE230
3B24W	2858	1K24, 428T, 732A
3B24WA	4021	732A, 428T, 3B24
3B26	3575	
3B28	1835	RR3/250, ESU130, 2H28, GXU1, 2G/402A
3B29	3689	1K29
3B/100B	1689	PA1
3B/102B	84	
3B/105D	1759	2C26A
3B/151A	1648	4205E
3B/152K		11A1
3B/200B	1047	TZo5-20, T206
3B/240M	2214	
3B/241M	5116	
3B/252B	1688	4033L
3B/254D		6BD4A
3B/251A	1448	4043C
3B/350/A/B	1448	4043C
3B/400A	1452	4300A
3B/401J	127	
3B/402A		ES1101
3B501A	49	
3B/503B		4304CB
3B/504B	1288	4304CB
3B/650A		4094
3B/651A		4242
3B/850A	25	4242A, ES85
3B/851A	1620	DET6, 4094A
3BKP2		DN7-78
3BKP31		DH7-78
3BL2A		
3BLP7		DP7-10
3BLP31		DH7-10
13BM2A		
3BN2A		
3BN4A		
3BNP1		DG7-52A
3BP1	814	3BP1A
3BP1A	2934	
3BVP2		D7-15GL
3BVP7		D7-15GM
3BVP11		D7-15DG
3BVP31		D7-15GH
3BX6		XF80
3BY6		XF85
3BY7		XF85
3BYP31		DH7-11
3C4		DL96, 1P1, N25
3C6		XXB

TYPE	CV No.	EQUIVALENTS
3C22	999	
3C23		PL3C23, TQ1/2
3C24	789	2T24
3C31/C1B	1765	5664
3034	941	HK24, 25T
3C45	372	XH3-045, 1G45P
3C/100E		ES1102
3C/201A		4212E
3C/250A	1034	DET3
3C/270A	1252	4212E, V1505, MY3-275
3C/270E		DET27R
3C/350E	30	4270A
30/351H	27	4357A, 833A, TY4-350
3C/495A	3581	V1501
3C/500E		14D12
3C/750G		EHZ350
3C/751E		14D14
3C/800E		15D12
3CN3A		
3CV3		
3CV3A		
3CZ3		
3D6/1299	815	1299
3D21A	2659	5B/152D
3D22	2851	4G/401A
3D/100A	1422	
3D/102E		ES1001
3D/120E	1422	3D/100A
3D/150G	2735	4015A
3DB3		
3DC3		
3DJ3		
3DL4		YC88
3DP1	816	
3DT6A		
3E29	3599	QQV5-P10
3EG1	1526	701D
3EH7		XF183
3EJ7		XF184
3EP1	817	1806P1
3ER5		YC95
3ER6		PC95
3FP7	1761	
3G10		3G130
3G15		01A
3G/450A		ZT1011, 21B12
3G/501A	2215	TK2/6, XR1-6400, 5545
3G/502A		6807, XR1-6400A
3G/510A		21B13
3GP1	516	
3GRK	442	GEX35, 0A73
3H/151J	2516	2C39A, TD1/100A
3HA5		
3J31	1788	
3J/121E	28	ACT9
3J/122E		BR1138
3J/160E	2245	
3J/162J		BR1129
3J/166E		16J12

TYPE	CV No.	EQUIVALENTS
3J/170E	2905	
3J/195E	5071	
3J/196E	1688	ESA891
3J/197E	904	ESA892
3J/198E	2687	ESA5000
3J/260E	2908	
3JC6		
3JC6A		
3JD6A		
3J06		
3JP1	2935	DG7-14
3JP2		DN7-14
3JP7	2869	DP7-14
3JP11		DB7-14
3JP12	2816	
3KP1	3733	
3KT6		
3LD13		T95, 1W
3NP4	1737	MW6-2
3P/270B	2950	129B, 30/191E
3Q4	818	N18, DL95
3Q5GT	819	DL33, N16, N15
3Q84E		4220C
3Q/120G	1605	4013C
30/150E	1450	4228A
30/167E		ESW1500
3Q/180E	1603	4014A
30/181E	1600	4006A
3Q/183E	2749	4081A
30/184E		4220C
3Q/185E		4220C
30/191E	570	3Q/195E
3Q/195E	570	3Q/191E
3Q/196E	2688	ESW891
3Q/197E	904	ESW892
3Q/198E	2687	ESW5000
30/211E	1604	SS1971
30/212E	1797	4081A
30/213E	1734	
30/214E	1797	4081A
3Q/220E		4009B
3Q/260E	446	
3Q/293E	1447	4030D
30/310E	3873	
3R/167E		16P13
3R/167S		16P12
3R/167W		16P14
3RP1	3941	
3S4	820	N17, DL92, 1P10
3V4	2983	DL94, N19, 1P11
3V/280B		4039A
3V/281B		VLS432A
3V290A		57
3V/390A	5027	PL5559, XG1-2500
3V/390B	5828	FG57
3V/390E	5027	
3V/391A		21N15
3V/420B	2126	
3V/407A		4049GD

TYPE	CV No.	EQUIVALENTS
3V/490A		XG2-6400
3V/490E		4049GD
3V/500A		EST102
3V/530E	477	
3V/531E	477	
3V/540A		21N12
3V/590E		4080GA
3W4		3S4SF
3WP1	3946	DG7-36
3WP11		DB7-36
3Z/252E		ESV4002
4-65A	1905	QY3-65, 3F65
4/100BU	1264	FW4500, U18/20
4-125A	2963	4F21, 4D21, Q160-1, RS685
4-240A	2131	
4-250A	2964	QY4-250, 0400/1, 5F22, 5D22
4-400A	3879	QY4-400B, 5F23
4-1000	3880	7F25
4A1	821	
4A/137B	243	4045A
4B13	26	813, QY2-100, 5C/100A
4B22	2936	
4B24	822	EL3L
4B25		WL670A
4B26	1836	1163
4B28	2777	
4B30	934	15R, 8022
4B31	3510	
4B32	2518	RR3-1250, DQ4, GXU2, 2G/472B
4B35	926	12X825, WE327A
4B36	2779	20X672
4B/602E		C1149/1
4B/700A		4282B
4B/700E		4282B
4BL8		XCF80
4C1A		4C1
4C4		4C3
4C21	2576	211, 211W
4C22	2987	HF100
4C27	92	E1232
4C30	933	15E, 8023
4C35	1787	XH8-100
4C/100A	2756	4260A
4C/800E		4278A
4CF8		PCF86
4CM4		PC86
4CSUA	1267	1DS, U4020
4CX1000A		RS4, 791
4CX5000A	2895	ACS5, RS2793
4D1	1109	HL132D
4D21	2963	Q160/14-125A, RS685
4D32	3543	C1123
4DL4		PC88
4DT6A		4DT6
4E27	824	HK257B
4EH7		YF183
4EJ7		YF184
4EP1		DH10-94
4EP7		DP-10-94

TYPE	CV No.	EQUIVALENTS	TYPE	CV No.	EQUIVALENTS
4EP11		DB10-94	4MK8		
4EP31		DH10-94	4PR60A	2752	QV20-P18, C1133
4ER5		PC95	4Q025	1625	RG3-250
4ES8		XCC189	4R-HH8		4KN8
4F21	2130	6155, QY3-125	4SH	1126	
4FR1SR	2519	4X150A, QV1-150A	4SHA	825	
4FC7		XCC89	4T16		100TL
4FP7		5087	4T17	1924	100TH
4FY5		PC97	4T100		813
4G8	7028	2R14, 1S003	4THA	826	A36C, TH4, AC/TH1
4G23		3C23	4TP2		DN10-18
4G63		5563	4TP7		DP10-18
4G93		393A	4TP11		DB10-18
4G/280K	797	2D21, 20A3, EN91	4TP31		DG10-18
4G/281D	1848	20A2	4TPB(CLEAR)	828	
4G/320D	1424	21A1	4TPB(MET)	829	
4G/401A		3D22	4TSP	830	TSP4
4H07N		4H07	4X150A	2519	QV1-150A, 4F15R
4H32	2518	4B32, 3B22, RR3-1250, GXU-2	4X150D	3991	4F20R, QV1-150D
4H72		872A	4X150G	3893	QV1-150G
4H73		673	4X250B	2487	4H/160M, QV2-250B
4H88		8008	4X500A		QBL4/800, QY4/500A
4H/135M	2519	4X150A, QV1-150A, 4CX250B	4XP	1168	AC044, PP3/250, PX4
4H/136M	3991	4X150D, QV1-150D	5/03HM	5282	AL13-36
4H/160M	2487	4X250B	5/04HM	1868	CV3959, SFP7A, MF13-1
4H/182E	1883		5/04TM		SFP4A, MW13-35
4HA5		PC900	5/62CM		5BHP1
4HC/160M	6137	4CX250B	5/62PM		5BHP11
4J26	3779		5A6	2360	
4J27	3780		5A102A	3784	
4J28	3781		5A/102D	1724	329A
4J29	3782		5A/105A	1726	
4J30	3783		5A/128B	244	4046A
4J31	1914	M518A	5A/136A	2619	4328A
4J33	1916		5A/136D	245	4328D
4J34	1897	M518A	5A/150A		QV05-25, 807, 4310A
4J35	1898	M518A	5A/156M	1136	EF54
4J50	2284	JP9-250	5A/157D	358	EF37A, 0M5B
4J52	3569	JP9-80	5A/159G		6AM6
4J52A	5018	IP9-80A	5A/159N	2000	EF91, HP6, 6AM6, Z77
4J53	513	M518	5A/160H		6F11, 6AM6, 6064
4J54	3947		5A/160K		6F11, 6AM6, 6064
4J55	3948		5A/163K	1635	
4J56	3949		5A/164K	3536	LS408A
4J57	3950		5A/170K	3998	E180F, 6688, EF861
4J58	3951		5A/172G	4501	7432
4J78	3953	JP9-250A	5A/173G	4502	7433
4JC6			5A/174G	4503	7434
4JC6A			5A/175G	4506	
4JC/201E		7007	5A/185K		D3A
4JD6			5A/189K	4014	6064, M8083
4JD6A			5A/200D	1116	6F32
4JL6			5A/201K	2209	6F33
4KE8			5A/204D	276	11E2
4KM100LA		K376	5A/206K	2243	SP41
4KM100LF		K377	5A/207D		V453
4LJ8			5A/208D		V453
4LP7		DPM10-93	5A/210K	416	6F17
4LP11		DBM10-93	5ADP1	5035	DG13-34
4LP31	5369	DHM10-93	5ADP2	5793	DN13-58, DG13-78



TYPE	CV No.	EQUIVALENTS
5ADP11		DB13-34
5AL5	1377	GZ34
5AP1	832	1805P1
5AQ4	1864	GZ32, 5V4G, 5T4
5AR4	1377	U52, GZ34
5AZ4	1268	U50, R52, 5Y3
5B1	1018	Z21, PM12, S215
5B21		1164
5B/100A	1369	4061A
5B/102D		11E14
5B/103B	73	11E3
5B/104D		ZAA
5B/151A	1080	4307A, 307A
5B/152D	2659	3D21A
5B/250A	124	QV05-25, 807, QE06/50
5B/251M	428	5B/254M
5B/252M	391	LS650, 5B/255M
5B/253M	499	5B/256M
5B/254M	428	5B/251M
5B/255M	391	LS650
5B/256M	499	5B/253M
5B/257M	2220	
5B/258M	2347	
5B/300B	834	
5B/351D	345	12E1
5B/352D		12E1A
5B/353D		12E1B
5B/354D		12E14
5B/355D		12E1C
5B/362D		12E13
5B/502A	1095	828
5B/600A	1081	4052A
5B/700A	631	828
5B/900A	6045	13E1
5B/901A		13E12
5BC3A		
5BHP1		DG13-58, DG13-78
5BHP2		DN13-78, DN13-58
5BHP11		DB13-58
5BHP31		DH13-78
5BKP1	5168	DH13-97
5BKP7	5760	DP13-97
5BKP/31	5168	DH13-97
5BP1	601	5HP1
5BP4/1802P4	836	5BZ7
5BX7		5BZ7
5C22	2520	XH16-200, HT415
5C/100A	26	813, QY2-100
5C/101A	1372	4669A
5C/450A	1506	ESP450
5C/500		P300-1
5CBP2		DN13-76
5CBP31		DH13-76
5CL8A		
5CLP7		DP13-10
5CLP11		DB13-10
5CLP31	5811	DH13-10
5CP1	600	DG13-2
5CP1A	2191	DG13-2
5CP7	838	5CP7A
5D21	2814	P552/1E, Q160-1, 4-250A, 4B/602E
5D22	2964	Q400-1, RS686

TYPE	CV No.	EQUIVALENTS
5D/100A	1627	
5DHP1		MG13-10
5DHP32		MM13-10
5DMP2		DN13-38
5DMP7		DP13-38
5DMP11		DB13-38
5DMP31		DG13-38
5DSP2		DN13-18
5DSP11		DB13-18
5DSP31		DG13-38
5DZP31		DBM13-10, E13-10GH
5EGP1		5ADP1
5ES8		YCC189
5F22A	2131	6156, QY4-250
5F23A	3897	5727, QY4-40
5FC7		YCC89
5FP4A		MW13-35
5FP7	718	MF13-1, MP13-39
5FP7(Special)	1789	5FP14
5FP7A	3959	MF13-1
5FP11	5070	MB13-1
5FP14	1789	
5FP19		MF13-39
5GH	2247	
5GH8A		
5H4	840	
5H26		
5H28		
5H69A		869B
5HP1	3583	5BP1
5HP1A	3583	5BP1
5J23	542	
5J26	3602	JNT1-500W
5J29	3842	
5J30	3843	
5J31	5844	
5J32	1538	
5J59	3952	
5J/180E	445	
5JP1	1791	5JP1A
5JP2A	3918	
5L/444	311	
5LP1	741	2511A5
5MP1	740	2505A5
5MQ8		
5P29		
5R4GY	717	5R4WGA
5R4WGY	2835	
5T01A	1868	MF13-1, 5FP7A, MF13-39
5T03A		MF13-39
5T4	1846	U52, GZ34, 5U4
5T21		250TH
5T33	635	833A, TY4-350, 3C/402E
5U4G	575	U52, GZ31, 5V4G
5U4GA		
5U4GT	841	U52
5U8		XCF82
5UP1	5223	DG13-22
5V4G	729	GZ32, 5AQ4, 52KU
5W4	1849	U50

TYPE	CV No.	EQUIVALENTS
5W4G	842	
5W4GT	503	
5X4	1852	
5X4G	1851	
5Y3G	1854	U50, R52, 5AZ4
5Y3GT	1856	U50, R52, 5AZ4
5Y3WGTA	4027	
5Y4GT	1857	
5Y49		
5YP1		DG13-54
5YP2		DN13-54
5YP7		DP13-54
5YP11		DB13-54
5Z3	1861	U50, 4274A, 22S/200A
5Z4	1864	GZ30, R52U50
5Z4G	1863	GZ30
5Z4GT	2748	GZ30
6/02K		1652M
6/30L2	5264	B729, 6GA8, ECC804
6A3	730	
6A6	1867	HLA2, 41MTL, 354V, ACHL, B63
6A7E	1870	6A7
6A7S		6A7
6A8	579	X63
6A8G	578	X63
6A8GT	580	
6A/203K	132	6H1
6AB4		EC92
6AB5	843	6N5
6AB7	1873	1853
6AB8		ECL80, LN152, 63TP
6AC5G	844	
6AC5GT	845	
6AC7	660	1852, 6AJ7
6AD7	1878	
6AD8		EBF81
6AE8	5115	X79
6AF4	5036	EC93
6AF4A	5074	
6AF6G	847	
6AG5	848	EF96, 6BC5
6AG6	1438	EL33, KT61, 6M6
6AG7	1882	EL821
6AH6	2521	
6AH9		
6AJ4	5126	EC84
6AJ5	995	
6AJ7	849	6AC7, 1852
6AJ8	2128	ECH81, 6C12, X17
6AK5	850	EF95, 5654, E94F, EF905, 5591, 6096
6AK5W	2877	M8100
6AK6	1762	EL91
6AK7	1784	6AG7
6AK8		EABC80, 6LD12, DH719, 6T8, 6GX8
6AL3		EY88
6AL5	283	EB91, 6D2, D77, EAA91, M8079
6AL5W	2882	M8212, 5726
6AL7	3708	
6AM4	5073	
6AM5	136	EL91, N144, 7D9, 6P17, N77
6AM6	138	EF91, 6F12, Z77, SP6, 8D3, 6064

TYPE	CV No.	EQUIVALENTS
6AN4	3989	
6AN5	2854	
6AN7		ECH80, 6AN8
6AN8A		
6AQ4	417	EC91, 6L34
6AQ5A	1862	EL90, N727, 6AQ5
6AQ5W	2883	M8245, 6005
6AQ6	2937	EBC91, 6AV6, 6066
6AQ8		ECC85, 6L12, B719, 6463
6AR6	3613	EL34
6AS6	2522	
6AS6W	2884	M8196, 5725
6AS7G	2523	A1834, 6080
6AT6	452	EBC90, DH77
6AT8A		6AT8
6AU6A	2524	EF96, 6AU6
6AU6WA	4023	
6AU7	5052	ECC82
6AU8A		6AU8
6AV3		EY89
6AV4	135	EZ91
6AV6	2526	EBC91, DH77
6AX8	5065	6V8
6B2P		
6B4		6A3
6B4G	851	
6B5	1885	
6B6	1887	DH63
6B7	1891	
6B7E	1891	6B7
6B7S		6B7
6B8	1893	EBF32
6B8G	1893	EBF32
6BA6	454	EF93, W727
6BA8A		6BA8
6BAW	5037	5749
6BA7	2527	
6BC4	5038	
6BC5	848	6AG5, EF96
6BD7		EBC80
6BD7A		EBC81, 6LD13, 6BD7
6BE6	453	EK90, X77, X727, 5750
6BE7		EQ80
6BG6	1887	
6BH3A		
6BH5		EF81
6BH6	3908	E90F, 6265, 7693
6BJ3		
6BJ5		N78
6BJ6	3909	
6BK4B		
6BK4C		
6BK6		
6BK7B		
6BK8	2901	EF86, 6267
6BL6	3614	
6BL7	5039	
6BL8	5215	ECF80, 6C/6
6BM6	3616	
6BM6A	3939	

TYPE	CV No.	EQUIVALENTS	TYPE	CV No.	EQUIVALENTS
6BM8		ECL82, 6PL12	6CN5	862	N66, EL35
6BN3			6CN6	450	EL38
6BN4A			6CQ6	2937	9D6, EF92, W77, 6F21, QA2400
6BN5	3526	EL85	6CQ65		
6BQ5	2975	EL84, N709, 6P15	6CQ8		6CQ8
6BQ6	5040		6CQ8A		
6BQ7A	5365	ECC180, 6BQ7	6CR4	A2521	
6BR5	1352	EM8065ME	6CS6	453	EH90
6BR7	2135	8D5, 6059	6CT3		
6BR8A			6CT4	5242	A2599
6BS3A			6CT7	3883	EAF42, WD150
6BS4		EC93	6CU7	3888	ECH42, 6C9, X150
6BS7	5086	EF86, 8D7	6CV7	3882	EBC41, LD3, 3C10, DH150
6BT4	3891	EZ40, UU9, 66KU, U150	6CW5	5094	EL86
6BT6	452	EBC90, DH77, 6AT6, 6066	6CW7	5281	ECC84, 6L16, B319
6BW4	5072	EZ81, UU12, U709	6D1	1092	EA50, 6DR4, SB35
6BW6	2136		6D2	383	6AL5, EB91, D77, D152, DD6
6BW7	5817	EF80, 8D6, 2152	6D4	1949	EN93
6BX6	1376	EF80, Z719, Z152, 64SPT	6D6	1900	
6BY7	1375	EF85, W719, 6F19	6D7	1776	
6C4	133	ECH90, L77, EC90, QA2401	6D8	1902	X73M
6C4W	2842	EC90	6DA5	5055	EM81
6C4WA	4058	M8080	6DA6	5156	EF89
6C5	582	L63, 6J5	6DC8		EBF89, 6FD12
6C5G	581		6DG7		EM85
6CFG7	583		6DJ8	5358	ECC88
6C6	585		6DL4		EC88
6C7	854		6DL5		EL95
6C8G	1896		6DN3		
6C9	3888	ECH42, X150, ECH113	6DR8		EBF83
6C10	3888	ECH42, X150, 62TH, 6CU7	6DS8		ECH83
6C12	2128	ECH81, X719, 6AJ8	6DT6A		
6C16	5215	ECF80, 6BL8	6DU6		EF89F
6C21	855	ZP527, 1000SP	6DW4B		
6C31	1581	ECH35, X65, 6K8, 600000000	6DX8		ECL84
6C56		EH90	6DY5		EL82
6CA4	5072	EZ81, UU12, U709	6E5	1906	
6CA7	1741	EL34, KT77	6E8		X61, 6K8
6CB5A			6EC7		6F18
6CB6	3995	EF190, 6CF6	6EH7	5831	EF183, 6F29
6CD6GA			6EJ7	5810	EF184, 6F30
6CD7	394	EM34	6EL7		EF812
6CF6	3995	EF190, 6CB6	6ER5		EC95
6CF8	2901	EF86, EF806S, Z729, 6F22	6ES6		EF97
6CH6	2127	EL821, 6132, 7D10	6ES8	5331	ECC189
6CG3			6ET6		EF98
6CG8A			6F1	3841	
6CH6			6F4	2939	
6CJ3		6CG8	6F5	1909	H63
6CJ5	3886	EL821, 6132, 7D10	6F5G	1908	H63, N63
6CJ6	2721	EL81	6F5GT	1910	N63, KT63
6CK3			6F6	1912	
6CK5	3889	EL41	6F6G	1911	KT63
6CK6	2726	EL83	6F6GT	731	KT63
6CL3			6F7	1915	6F7E, 6F7B
6CL6	5041		6F7E		6F7B
6CL8			6F8	1819	
6CL8A		6CL8	6F8G	1917	
6CM4		EC86	6F11	1901	6AM6, 8D3, EF91, Z77, SP6
6CM5	2940	EL36	6F12	138	

TYPE	CV No.	EQUIVALENTS
6F13	1839	1T5GT
6F14	1919	
6F15	3886	EF41
6F16	3886	EF41, W150, 62VP, 6CJ5
6F17	416	5A/210K
SF18		W739, 6EC7
6F19	1375	6BY7, EF85, W719
6F20		N79, W729
6F21	131	EF92, VP6, W77, 6CQ6, 9D6
6F22	2901	EF86, Z729, 6267
6F23		EF812, 6EL7
6F24		EF814
6F26		EF85
6F28		EF80
6F29		EF183, 6EH7
6F30		EF184, 6EJ7
6F32	1116	5A/200D
6F33	329	5A/201K
6F33Special	2209	6AS6
6F50R		4X500A, QY4-500A
6FC7		ECC89
6FD12		EBF89
6FG6		EM84
6FH8		
6FQ5A		
6FV8A		
6FW8		
6G5		6U5, 6M1
6G5G		6M1, Y61, EM35
6G6G	1926	
6G8	7029	1S004
6G8G	856	
6G10		FG105, XGQ2-6400
6G45	2215	5545, XR1-6400
6GA8		ECC804
6GE7		
6GF7A		
6GH8A		
6GJ5A		
6GL7		
6GM8		ECC86
6GT5A		
6GW8		ECL86
6GX6		
6GX8		EAM86
6GY6		6GX6
6H1	132	V885, 6A/203K
6H5		6U5, 6M1, 6G5
6H6	1930	D63, EB34
6H6G	1929	D63
6H6GT	1931	D63
6HA5		
6HB5		
6HG5		6AQ5
6HG8		
6HU6		
6HV6		EM87
6J4	1763	M8248
6J4WA	5029	M8232
6J5	1933	L63
6J5G	1932	L63

TYPE	CV No.	EQUIVALENTS
6J5GT	1934	
6J6	858	ECC91, M8081
6J6A		
6J6W	2843	
6J6WA	4031	M8081, M8212, 6101
6J7	1936	Z63, KTZ63
6J7G	1935	Z63
6J7GT	1937	
6J8G	859	6C31, 6K8
6JB6A		
6JD5		
6JD6		
6JF6		
6JG6A		
6JKM6		
6JR6		
6JT6A		
6JU8A		
6JW8		ECF802
6JX8		ECH84
6KIP		
6K4	468	EC706778
6K4P		
6K5G	860	
6K5GT	861	
6K6G	1938	
6K6GT	1940	
6K7	1942	W63, W61, KTW63
6K7G	1941	KTW63
6K7GT	1943	
6K8	1945	X61, 6C31
6K8G	1944	X65, ECH35
6K8GT	1946	
6K25	2217	
6KD6		
6KH2P		
6KX8		
6L5G	862	
6L6	1948	KT66
6L6G	1947	EL37
6L6GA	2817	
6L6WGA	3618	5932
6L6WGB	2796	5881
6L7	1951	X64
6L6G	1950	KT66
6L10		6AG7
6L12		ECC85, 6AQ8, B719
6L13	492	12AX7, ECC83, B339
6L16	5281	ECC84, 6CW7
6L18	1899	
6L19	1850	
6L34	417	EC91, 6AQ4
6LB6		
6LD3	3882	EBC41, DH150, DH718, 6CV7, 62DDT
6LD12		EABC80, 6AK8, 6T8, DH719
6LD13		EBC81, 6BD7A
6LD20	1920	
6LM8		
6LQ8		
6LR6		

TYPE	CV No.	EQUIVALENTS
6LY1	1530	1652M
6LY8		
6M1	2747	6U5, EM35, Y61, 63ME, 6G5G
6M2	394	EM34, 6CD7
6M5		EL80
6M6		EL33, 6AG6, 6P25, KT61
6N030T		530/2K
6MB8		
6MD8		
6ME8		
6MF8		
6MJ		
6MK		
6MN		
6MV		
6N1P		
6N2P		
6N3		EY82
6N5	843	6AB5
6N6	1954	
6N6G	1953	
6N6P		
6N7	1957	
6N7G	1956	
6N7GT	1958	
6N8		EBF80, WD709, ZD152
6N15P		
6NK8		6R-HH8
6P1P		
6P2P		
6P4P		
6P5	1819	
6P7	864	
6P8		OM10
6P9		
6P15	2975	EL84, 6BQ5, N709
6P17	136	EL91, 6AM5, 7D9
6P25	1853	KT61, 6AG6, EL33, 6P26
6PX6		6P25, EL33, KT61
6Q4	1886	EC80
6Q5	1815	884
6Q6		DH73
6Q7	588	DL163
6Q7GT	587	DH63
6R3	5905	EY81
6R4	1865	EC81
6R6G	1960	
6R7	1963	DL63
6R7GT	1964	
6R-HH8		6NK8
6R-HH9		6R-HH8
6RR8C		6RR8
6S1P		
6S2	2966	EY86
6S2A		EY87
6S4A		
6S7	1975	KTW61
6S7G	1974	
6SA7	1966	6SA7GT
6SA7GT	1967	
6SC7	1969	

TYPE	CV No.	EQUIVALENTS
6SC7GT	1970	
6SD7GT	865	
6SF5	1972	
6SF5GT	1973	
6SG7	1978	
6SH7	594	
6SH7GT	595	
6SH7L	5067	
6SJ7	591	
6SJ7G	590	
6SJ7GT	592	
6SJ7WGT	3619	
6SJ7Y	866	
6SK7	1981	6SL7
6SK7GT	1982	
6SL7GT	1985	ECC35
6SN7	278	B65, QA2408
6SN7GT	1988	B65, ECC32
6SN7WGT	3627	QA2408
6SQ7	1990	
6SQ7GT	1991	
6SR7	867	
6SS7	1993	
6ST7	1996	
6ST7G	1995	
6SU7		ECC35
6T4	3808	
6T7		DH73
6T7G	500	
6T8A		EABC80, DH719, 6AK8, 6T8
6T35		15D12
6TD34		6TD33
6TH8		6P8
6U3		EY80
6U4GT	5287	
6U5/6G5	504	6M1
6U5G	2747	Y61, Y63, EM35
6U7G	706	W63, KTW63
6U8A	5065	ECF82, 6678, 6U8
6V3A	5021	
6V4	1535	EZ80
6V6	510	
6V6G	509	
6V6GT	511	
6V7G	870	
6W2		6X2, EY51, R12, R12A
6W5		U70, EZ35
6W7		8D4
6W7G	512	
6W50		W5/1G
6X2	426	EY51, R12, R12A, 6W2, U43, U151
6X4	493	EZ90, U78, QA2407
6X4W	4005	6063
6X5	573	U70, 6ZY5, EZ35
6X5G	572	
6X5GT	574	U70, EZ35, U147
6X5WGT	3734	
6X8A		6X8
6Y3	1816	
6Y6G	515	

TYPE	CV No.	EQUIVALENTS
6Y6GA		
6Z4	619	84
6Z5	871	1225
6Z7G	872	
6ZH1P		
6ZH2P		
6ZH3P		
3ZH4P		
3ZH5A		6X5, EZ35, U70
6ZY5	873	
6ZY5G	872	
7	874	
7A	823	WE7A
7A2	1174	Pen4VA, AC/Pen, MKT4, PT4
7A3	1181	PenA4, AC2/Pen, KT41
7A4	1770	
7A6	876	
7A7	877	W81
7A7LM	877	W81
7A8	878	
7AH7		PCC84
7AHP1	2352	DG16-22
7AHP7	2498	DP16-22
7AHP11		DB16-22
7AN7	5192	PCC84, B319, 30L1
7AU7		XCC82
7B	824	HK257B
7B4	879	
7B5	880	EL22, KT81, N148
7B5E	880	
7B5LT	881	
7B6	882	DH81, DL82
7B6LM	822	DH81
7B7	522	W149
7B8	883	
7B8LM	883	
7BP7	884	1813P7, 7B4
7BP7A	3637	1813P7
7C4/1203A	2706	7C4
7C5	885	N148
7C5LT	886	7C5
7C6	887	DH149
7C7	1777	
7C23	3926	5924, TY6-5000A
7C24	5762	
7D5	1425	N30
7D6	1672	Pen3520, Pen36C, Pen383
7D8	889	Pen13C, Pen1340
7D8S	1328	
7D9	136	EL91, 6AM5, N144, 6P17, N77
7D10	2127	EL821, 6CH6, EF82
7DJ8		PCC88
7E5/1201	2704	1201
7E6	891	
7E7	892	
7E58		PCC189
7ED7		30F5
7EK7		PCC805, 30L15
7ES8		PCC189
7F7	893	

TYPE	CV No.	EQUIVALENTS
7F8	2968	
7F16	3886	EF41, 6CJ5
7F25A		4-1000A
7FC7		PCC89
7G7	894	EF22
7GU7		PCF805
7H7	895	W148, W81
7H57		857B
7HG8		PCF86
7J7	897	
7K7	896	
7K26		
7KY6		
7MB1A	1880	
7N7	898	
7Q7	899	
7R7	900	
7S7		X81, X148
7UP7	3639	
7W7	902	1282, 7V7
7Y4	901	U82, U149
7YP2	5061	U82
7Z4	1790	T951W
8/03TB		T951T
8/032M		SP4, MSP4, 4046A, 5A128B
8A1	1124	DG7-36, AC/5G
8A1	1282	WE8A
8A3	3813	30C1, PCF80, LZ319, LZ329, 9A8
8A8		8AU8
8AU8A		T954S
8B/08L2M		T969S
8B/08LB		T954Y
8B/08LM		T969Y
8B/082B		T954T
8B/082ZM		T969T
8B/087B		T954T
8D2	1108	SP13C
8D3	138	DF91, 6AM6, 6F12, SP6, Z77
8D4		6W7
8D5	2135	6BR7
8D6		6BW7
8D7		6BS7
8D/03L3M	6143	
8F66R		6166
8G7	7030	1S007
8GJ7		PCF801
8HG8		PCF86
8NP12		8NP12
8T21		9C21
8T21R		9C22
8T71R		5671
8T92		892
8T92R		892-R, ESA892, 3J, 197E
9/01	254	30D5
9/02HM		T921Z
9/03HB		T938Z
9/03LB	5300	T938Y, 2273P
9/0N	262	
9-3	368	
9A1	1172	VMP4G, AC/UP1, MVS/Pen

TYPE	CV No.	EQUIVALENTS
9A8		PCF80, LZ319, 30C1, LZ329, 8A8
9AB4		UC92
9AK8		PABC80
9AQ8		PCC85
9BR8		9U8A
9C25		
9D2	1106	VP1322, 13VP8
9D5	1053	OM5, EF39
9D6	131	EF92, 6F21, W77, 6CQ6, VP6
9D1387		S102/3K
9EN7		PCF800, 30C15
9E4D		PD500
9FG6		PCE800, 30FL1
9GB8		
9HP7		905
9JP1	1783	
9KC6		PCF802
9LA6		
9LD1	254	
9L01A	464	T921Z
9LP7	2789	2P455
9MD6	262	
9M06A	2108	
9MN8		
9MW5AX	2192	
9P9		9BM5
9PK5	109	
9RP33	5300	2273P, AL22-10
9T71		5770
9U8A		PCF82, 9U8
10	603	2C23
10Special	906	GL1602
10C1		X145, X118
10C14		UCH81, X119, 19D8
10D1	1300	DD620, 2D13C
10D2		UAA91
10D3	1419	HAD1320, 13DHA
10F1		Z145
10F9		W118, W145, 12AC5
10F18		UF89, W119, 13EC7
10FD12		UBF89, WD119, 19FL8
10GF7A		
10KP7	3693	
10L14		B109, UCC85
10LD3		DH118, DH142, UBC41, 14L7
10LD11		DL145
10LD12		UABC80, DH109
10LD13		DH119, UBC81
10M2		UM4, UM35
10P13	1977	N118, N145, UL41
10P18		N119, UL84, 45B5
10PL12		UCL82, 50BM8, LN119
10Y	603	
11A1		3B/152K
11A2	2813	AC/HL/DD, MHD4, DDT
11D3	1419	HLDD1320, TDD13C
11D5	1695	DH30
11D12		ECC230, A4535, 33B/160D
11E1	2798	QQV03-10
11E2	276	5A/204D
11E3	73	V1120B, 5B/103B

TYPE	CV No.	EQUIVALENTS
11E13		55B/100K
11E14	5830	EL360
11E15	2799	QQV03-20A, 6252
11E16	2797	5894, QQV06-40A
11HM7		
11K7		11J7
12/02HM		T922Z
12/03HB		T939Z, 3073Q
12/03LB		T939Y
12/04HM	429	MF31-55
12/04LK		MF31-22
12/04MH		3069M
12/10HB		T9572
12/10LB		T957Y
12/44HM		T9532
12/44L2M		T953S
12/44L3M		T953S
12/44NM	2328	MF31-95
12A	5080	EF37A
12A/112A	1774	EF9
12A5		908
12A6		525
12A6GT		526
12A7		909
12A8GT		910
12AC5		UF41, W142, 10F9
12AEP6	429	MF31-55, C12R
12AH7GT		529
12AH8		5317
12AJ8		HCH81
12AL5		UAA91
12AL6		UAA91
12AT6		HBC90
12AT7	455	B309, ECC81, B152
12AT7WA	4024	M8162, ECC801S
12AU6		1961, HF94
12AU7	491	B329, ECC82, 6067
12AU7A		ECC802S
12AU7WA	4003	6189, M8136
12AV6		HBC91
12AW7		12AW6
12AX7	492	ECC83, 6L13, B339, 6057
12AX7A		
12AY3A		
12AY7	3650	
12AZ7A		
12B4A		
12B8GT	911	
12BA6	1928	HF93
12BE6		HK90
12BF11		
12BH7	5042	
12BH7A		
12BK6		HBC91, 12AV6
12BY7A		
12C8	531	
12C8GT	3827	
12CK3		
12CL3		
12CY6		12CX6

TYPE	CV No.	EQUIVALENTS	TYPE	CV No.	EQUIVALENTS
12DA6		UF89	12SY7	3668	
12DP7	913		12T01A	1869	
12DP8	914	12DP7	12T03A	2328	MF31-95
12E1	345	5B/351D	12X825		68510
12E1A		5B/352D	12XP4		MW31-74
12E1B		5B/353D	12XP4A		MW31-74
12E1C		5B/355D	12XPR4A		MW31-74
12E12	398	715B, P535/1E, 4B/603E	12Y4	523	
12E13		5B/362D	12Z3	927	14Z3
12E14		5B/354D	13CM5		XL36
12FB5		30P12	13D1	423	25SN7GT
12FG6			13D2	1988	6SN7GT
12FP7	915		13D3	2212	6158
12FX5			13DHA	1419	11D3, HLDD320, TDD13C
12FX8			13E1	2377	C1158, 5B/900A
12FX8A		12FX8	13E12		5B/901A
12GC6			13EC7		10F18
12GH			13GBS		
12H6	916		13GC8		30PL1
12HG7			13GF7A		
12HL7			13PGA		15D1, FC13C
12J5	534		13SPA	929	8D2, SP13C
12J5GT	535		13VPA		9D2, VP1322, VP13C
12J7GT	917		13Z10		
12JB6A			14/03TB		T935W
12JQ6			14/03ZB		T935T
12J126A			14/04TB		MW36-67
12K7		W76	14A7	3935	12B7
12K7GT	918	W76	14ABP4		AW36-20
12K8	703	X76M	14ABP4A		AW36-20
12K8GT	3927	X76M	14AF7		XXD, 14AF4
12L01A	2162	T922Z	14AHP4A		AW36-80
12L03A		T922Z	14AKP4A		MW36-24
12MD8			14C7		1280
12MW3		C12D	14D12		3C/751E
12MW3A		C12B	14D13	1252	CV1619, 212E, MY3-275
12Q7		DH76	14F7	930	
12Q7GT	547	DH76	14K7		UCH42, X142, 141TH
12S7		UAF42, WD147	14KP4A		MW36-24
12SA7	537		14L	1087	
12SA7GT	538		14L7		UBC41, DH142, 10LD3
12SC7	540	1634	14LP4		MW36-24
12SF5	919		14R7	3937	
12SF5GT	920		14S7	3936	
12SF7	921		15	931	
12SG7	694	6SG7	15A	986	
12SH7	922		15A2	3576	MX40, 41MPG, A80A, FC4, X42
12SH7GT	3651		15A6		PL83, N309, N153
12SJ7	697		15B	326	
12SJ7GT	698		15BD7A		UBC81
12SK7	543		15CW5		PL84, N379, 30P18
12SK7GT	544		15D1	2956	FC13C, 15D2
12SL7GT	924		15D2	1107	15D1
12SN7GT	925	B36	15D12		3C/800E
12SP7	3655		15DQ8		PCL84
12SQ7	546	DH76	15E	933	8023, 4C30
12SQ7GT	547		15L01A	1744	
12SR7	700		15MW3A		C15B
12SW7	3666		15R	934	4B30, 8022
12SX7	3697	B36	16A	136	6AM6, EL91, 6P17



TYPE	CV No.	EQUIVALENTS	TYPE	CV No.	EQUIVALENTS
16A8		PCL82, 30PL12	20A1	1424	TH4B, AC/TH1, TH4, X41, 41STH
16AQ3		XY88	20A2	1848	EN32, 6574, 4G/281D
16J12		3J/166E, ESA2500	20A3	797	2D21, EN91, PL21
16P12		3R/167S	20CV	5120	
16P13		3R/167E	20D2		X31
16P14		3R/167W	20D3		12AH8
16STE		L102/2K	20K	1379	
16TP8		16TP6	21/03TB		T952N
17AX4			21/03ZB		T952T
17AX4GTA		17AX4	21/2	3584	
17AY3A			21A6	5077	PL81, N339, N359
17BH3A			21B6		PL81, N339
17BS3A			21B12		3G/450A, ZT1011, XR1-1600
17BQP4		MW43-69	21B13		3G/510E
17BTP4		AW43-80	21CJP4		MW53-20
17C8		UBF80, 171, DDP	21CLP4		AW53-80
17CK3			21DKP4		AW53-88
17CT3			21DKP4A		AW53-88
17CVP4		C17AA, CME1706, AW43-88	21ENP4		AW53-80
17DM4A			21ESB		21DJ8
17GJ5A			21N12		3V/540A
17GT5A			21N13	612	57
17JQ6			21N14	5828	3V/390B
17JR6			22A	5080	EF37A
17KV6			22BM3A		
17KW6		PL508	22JF6		
17Z3		PY81, V253, PY83	22JG6A		
18FW6A		18FW6	22JRC		
18FX6A			22KM6		
18FY6A			22M1		1B59
18GD6A			23AJP4		AW59-90
18GVB		PCL85	23AMP4		AW59-90
19AJ8		19D8, UCH81	23AQP4		AW59-90
19ALP4		AW47-91	23BCP4		AW59-90
19AQ5		HL9D	23DFP4		
19AQP4		AN47-91	24A	936	24E
19BD		PY80, U152, 19U3, 19X3	24B1	6008	V2023, GIT/180E
19BEP4		AN47-91	24B2	339	
19BR5		UM80	24C3	125	V2024, GIT/350E
19BX6		UF80	24E		24A
19BY7		UF85	24G		3C24
19CL8A			25A6	549	KT33
19C84		U191	25A6GT	550	
19D3		UCH81, 19D8	25A7GT	937	
19D8		UCH81, X119, 10C14, 19D3	25B6G	939	
19DC8		UBF89	25B8GT	940	
19E2	265	2S/370D	25CG3		
19FL8		UBF89, WD119, 10FD12	25CK3		
19G3	277	2T/240D	25CM3		
19G6	371	SU45, 2S/280K	25E5		PL36, 30P4
19G12		2T/360B	25F5A		
19H1	121	V1920, 2S/306B	25GF6		30P4
19H4	2180	2T/350D	25JQ6		
19H5	490	2S/550C	25L6	552	KT32
19H12		2S/590E	25L6GT	553	KT32
19SU		PY82, U154, U319, U192, 19Y3	25RE	942	25Y5
19T8		PY82, U319	25SN7GT	423	13D1
19U3		PY80, U152, 19X3	25T	941	HK24, 3C34
19X3		PY80, U309, U152, 19W3, 19Y3	25TG	789	HK24G, 3C24
19Y3		19W3	25U4		25D4

TYPE	CV No.	EQUIVALENTS	TYPE	CV No.	EQUIVALENTS
25W4			33A/100A	1750	
25W9			33A/138A	18	7074A
25X5		25X4	33A/158IV	1884	
25Y4		PY31, U31, 25Z4	33B/152M	1540	
25Y5	942		33B/160D		11D12
25Z4		U31, PY31, 25Y4	33JR6		
25Z5	555		34	1751	32
25Z6	558		34CM3		
25Z6GT	559		34E	1751	
26	943		34GD5A		
26A7GT	3577		35/51	1752	
26AE6		PY86	35A5LT	1753	
26AQ8		UCC85	35L6	561	
26B6			35L6GT	562	
26D	2727	3226D	35T	668	DET18
26J	2786		35TG	1754	
27S	944	27	35W4		HY90
27BL8		UCF80	35Y5		35Y4
27GB5		PL500	35Z3	564	
27M1	337	931A, 1P21	35Z3LT	726	35Z23
28AK8		UABC80	35Z4GT	2500	U76
28D7	945		35Z5	568	
28D7GT	946		35Z5GT	568	
28GB5		PL500	36	1775	
29C1	430	2A/230D	36AM3B		
29D	2728	3229D	37	606	
30	604		38	712	
30A	988	G	38A	712	
30A5		HL94	38A3		UY85, U119, U381
30AE3		PY88	39/44	1771	329
30C1		PCF80, 9A8, LZ319, 8A8, LZ329	39A	491	ECC82, 12AU7
30CA	987	V1040	40	2501	
30C12P1	1746		40PPA		7D3
30D5	1860		40SUA	1267	1D5, U4020, UR1C
30E7	400	V1063P1	40Z5	2530	
30E7/P1	400	V1063P1	40Z5GT	2530	
30EBP1	2216		41A	820	354, DL92
30F5		2329	41E	608	41
30FL2			41DS	1131	
30HM/HD	1140	PX25, 420XP, D024	41FP	2502	ML4, AC/P
30L1	5192	PCC84, B319, 7AN7	41MH	2503	MH41, 484V, HLA2, AC/2HL
30PL15			41MHF	1037	354V, AC/L, MH4
30P4		25GF6, PL36	41MHL	2504	354V, MH4, 244V, AC/HL
30P12		12BF5	41MLF	1038	41MHL, 244V
30P16		PL82, 16A5, N329, N154	41MP	1458	ML4, TT4, AC/P
30P18		PL84, 15CW8, N379, 15CW5	41MPG	2505	MX40, FC4, 15A2, X42, VHT4
30TWIN	1780		41MPT	2506	
31	947		41MRC		AC/2HL
31A3		UY41, U142, U404, 311SU	41MSG		MS4B, SP4, AC/SG, MS/Pen, SPT4A
31C2	2965	RL7076-2B	41MTL	1117	354V, AC/HL
31D14		T938Z	41MVSG		SP4
31E14		T939Z	41MXP	1122	PA1, AC/P1, 354V
32	711	32E, 34	41PGD	3576	15A2, FC4, MX40
32A	951	32G, 32E	41STH	2508	AC/TH1, X41, 20A1, TH4
32E	957	32G, 32A	42	609	42E
32ETSA			42E	609	42
32G	953	32A, 32E	42EC4		PY500
32J	958	26J	42MP/Pen	1181	PenA4, 7A3, PT4, KT41, AC2Pen
32L7GT	984	32A	42MPT	1325	
33	949		42/OT	2511	PenA4, 7A3, PT4, AC2Pen, KTA

TYPE	CV No.	EQUIVALENTS	TYPE	CV No.	EQUIVALENTS
41/OTDD	2512	PenDD, DDPP4B, DN41, AC/2	63DS	2731	3263DS
42/SPT	1444		63ME	2747	6M1, 6U5G, EM35, Y63
43	2514		63SPT	1091	EF50, Z90
43E	2514		63T1		ECL80, LN152, 6AB8
43IU	1039	R2, UU5, MU14, IW4/350	63TP		ECL80, 6AB8
44A/160M	415	TT15	64A		64
44IU	1039	R3, UU5, IW4/500	64ME	394	EM34, 6CD7
45	610		64SPT		EF80, Z719, 6BW7, 6BX67, Z152
45A5	1977	UL41, N142	64SU	135	EY91
45B5		UL84, N119, 10P18	65ME		EM80, 6BR5
45BQS	2634	367	66KU	3891	EZ40, 6BT4, V150, UU9
45DS	2528		67PT	3889	EL41, 6CK5, N150
45IU	2529		70B1	470	
45SP	596	38412, 2C45	71A	2541	12A
45Z5GT	2530		71A3	1764	CE2, 1P30
46	2531		71B		71
47	1772		72	709	RX232, 3B24
49	2532		72R	709	RX332, 3B24
50	2533		73	2543	RK73, RKR73
50BM		UCL82, 10PL12	73R	2543	RK73, RKR73
50BM8		UCL82	75		614
50C5	1959	HL92	75B1	284	QS75-20
50L6G	2534	KT71	75C1	4080	6065, M8161
50L6GT	571	KT71	76	615	37
50L66GT			77	616	
50Y6GT	805		78	2544	
51	487		78DS	1328	Pen, 1340, Pen13C
51A3		WL927	79	2545	4274A, 22S/200A
52CG	2896	203A, CMG22	80	617	
52KU	1863	5V4, GZ32	80A		80
53	2535		81	2546	
53A	2536	3-50J4	81M		81
53KU	378	U54, GZ37	82	1773	
54KU	729	GZ32, 5AQ4, 53KU	82AV4		
54NCP11	2885	54NCP11	82V	388	WL919
55	2537		83	618	82
55B/100K		11E13	83V	2547	22V/310A
55B/200K		C1134	84	2548	84, 6Z4
55CG	405	927, CMG25, CMG34X	84/6Z4	619	84
55N3		UY82	84A3		WL923
56	611		85	2549	
57	612	XG1-2500, 5559, BT5, 3V/390A	85A1	431	OE3
58	613		85A2	449	QS83/3, OG3, QS1209/5651
59	2538		85A4		WL928
59A3	2962	1N38A	86BA		2XM-600
59A4	2692	918	88D	2185	
59D		WL928	89	833	89Y
59TAV3		WL917	89D	2193	
60A3		WL920	89J	2750	
61A3		WL930	89Y	833	89
61BC	1979		90AG	2270	FZ9011G, CAG29
61BT	1979		90AV	2132	VA50, FZ9011V, CAV29
61DV3		WL929	90CG	2133	FZ9012G, CMG29
61P	2539		90C1	5173	QS1215
61SV		7634	90CV	2134	FZ9012V, CMV29
62BT	1745		90EG4	1587	901A
62DDT	3882	EBC41, 6LD3, 6CV7, DH150	95A1	286	SM95, QS95/10
62TH	3888	ECH42, 6C10, X150, 6CU7	100B1	1199	
62VP		EF41, 6F16, 6CJ5, W150	100R	2967	8020
63D	2540		100TH	2552	

TYPE	CV No.	EQUIVALENTS	TYPE	CV No.	EQUIVALENTS
101D	1778	3A/141A	210SPT	1049	Z22, Z21, SP2
101F	2553		210VPA	2574	W21, VP210
102D	1779	3A/142A	210VPT	1083	W21, VP210, VP2
104D		3A/144A	210VPT	171	
104V	1161	ML4, PA1, 45P, AC/P	211	620	4C21
105		PL105, XGQ2-6400	211(Special)	2576	4C21
108C1	1833	0B2, STV108/30, G108/1K, QS1208	211H		T100-1
111A	2554		212E	2577	4212E, MY3-275, 3C/270A
112	1774		212K		MW53-80, C21, KM
116Pen	1337		213Pen	5077	PL81, N339, 21A6
117L7GT	2556		215P	1019	PL15
117M7		117L7	215SG	1018	PM12M, Z21, S23
117N7GT	2557		218	2579	
117Z6GT	2558		220B	1032	PM2B, PD220
120A		4120A, B4B/1A	220C	2580	
121A	2560	4121A, B8B/1A	220DD	794	2D2
121K		C12FM, MW53-80, MW31-74	220HPT	1118	PM22A, 2200T, KT2
121VP		UF41, 12AC5	2201PT	1333	Z22
122A	2561		220LF	1313	
129B	2950	3P/270B, 3Q/191, E	220LPT	1195	KTW63
141DDT		UBC41, 10LD3, 14L7	220/OT	1118	PM22A, KT2, Pen220, PT2
141K		MW36-24	220P	1020	PL2, PM2
141TH		UCH42, 14K7, X142	220PA	1022	LP2, L2, P220, PB1
143D	557	D42	220PT	1051	Pen220A, PT240
150B2	2225	6354, QS1200	220RC	1312	
150B3	287	QS150/15	220SG	1018	Z21, 215SG, PM12, 5B1
150C2	1832	0A2, STV150/30, G150/45, QS1207	220TH	1082	Z24, TH2
150C3	216	0D3, VR150/30, G150/3D	220VS	2582	PM12M, V522, W21
150C4	1832	0A2, QS1207, G150/4K	220VSG	1028	PM12M
152RA	3878	2-150D	225DU	1454	
154V	1037	MHL4	228A	734	4228A, 3Q/150E
161	1708		230XP	1023	P2, PM202, P220A
163Pen		PL82, N329, 16A5	231D	2584	6AN5
164V	2562	MHL4	238B		5555
171DDP		UBF80, 17C8	239	1771	39/44
172K		MW43-69, 17BQP4	240B	2586	B21, PM2BA, PD220
173K		MW43-69, 17BQP4	240QP	1035	QP230, QP21
180C1		0B2	242A		ES85, 4242A, 3B/850A
182A		182	242B		4242A, ES85, 3B/850A
185BTA	1980	185BT	242C	2587	4242A, ES85, 3B/850A
200	2988	HV18	244A	2588	
202	1200		244V	1038	354V, MH4, HLA2
202DDT	1419	11D3, HLDD1320, TDD13C	249A		2V/400A
202STH		TH2321, TH21C	250TH	2589	RK63
203A		4242A	250TL		WL806
203B	2986		256B	2592	
204A	2563	UV204A	257A	2593	
205D	1749	3B/151A	258B	2594	
205E	2566	3B/151A	259A	2595	
205F	2567		262A	2597	
210DDT	1044	TDD2A, H207	264A	2598	
210DET	2569	HL2, 210HF, PM2HL	264C	2599	
210HF	2570	PM2HL, HL2, HLB1	267B	2600	F267B
210HL	2571	PM2HL, 210HF, HL210	270A	30	4270A, 3C/350E
210HPT		KTS, Pen220	271A	2601	
210LF	1021	HLB1, L2	272	2957	5557, XG5-500
210PG	1043	FC2, X22	272A	2602	
210PGA	1043	FC2A, X21, 210PG	274A	2603	424A
210RC	2977	HL2, HLB1, PM2HL	274B	684	5U4G, 274A
210SPG		210PG	275A	2604	

TYPE	CV No.	EQUIVALENTS
276A		4242A
278A		4278A, 4C/800E
279A	669	4279A
282A	2605	4282B, 4B/700A
293A	3829	
296A		WL849
300A	2608	4300A
300B	2609	9300A
302THA		TH2321, 302
303	2610	
303A	2986	
304	1202	
304TH	2611	HK304H, WL535
304TL	3580	
305D		WL801A
307A	2612	4307A
310A	2613	
310B	1781	310A
311		4242A, 242B, 203A
311A	2614	
311B		4311B
311CH		T100-1, 211H
311SU		UY41, 31A3, U142, U404
313C	2615	4313C, G150/1A
314A	2616	
316A	683	CL316A
322A	623	RK28A, 38803
323A	2617	
327A	2618	5637, 3-10063/327A, 4B35, 12X825
328A	2619	3B28A
329A	2620	
329L		329A
330B	2621	
331A	2622	
332A	2623	WE322A
332Pen	1401	CL33
337A	2624	WE337A
338A	2625	
340A	1782	
343A		4009B, 3Q/220E
346A	2626	
349A	2627	EL83, 6CK6
349B	2628	
350A	2629	
350B	621	38101, L801
350D	621	38101, L801
351A	2630	
351B	2630	
352A	2631	
354A	2632	
354B	1173	244V, A30D, AC/HL
354V	1173	244V, A30D, AC/HLMH4
357A	691	4357A, 3C/351H
362A	2633	
367	2634	
368A	710	
371B	3511	
375A	2636	
388A	2637	
393A	2638	

TYPE	CV No.	EQUIVALENTS
394A	2639	
400TDD	2521	6AH6
401A	967	E4103-B-4
401CAHA	389	
402Pen	1672	Pen36C
405BU	2640	
408A	2205	E4103-E-14, 5A/164K
408BU		DW2, 506BU, 7821, R1
408C	2111	408CAHA
408CAHA	2211	408CAHA
410LF	1152	L410
41OPT	1167	PM24A
415XP	1154	PM254
417A	2642	2K41
420T	2511	
420XP	1040	PX25, D024
428T	812	CE230, EB24
431U	1039	R3, IW4-500, MU14
436A		A2674
437A		3A/167M
441U		R3, UU5, IW4/50C
442BU	1796	R2, DW4-340, UU5, U14, 441U
446	3725	GL446
446A	932	1656
446B	687	2C40
446C	2272	
450TH	2572	
451PT	1977	UL41, 45A5, N142
451U	1264	FW4-500
460BU	2644	R3, DW4-500, U14, UU5
464A	688	2C43
471A	3586	1B21A
484V	1678	HLA2, AC2/HL, MH41
510AX		501
506BU	2645	DW2, U10, 1821, R1, UU5
506KB		506BU
517	2957	5557, XG5-500
522	999	3C22
531DX		529AX
532	2647	
532A	2648	1B32
536AX		533DX
541U		UL41
543B		543A
552	999	3C22
560BU	2645	U10, DW2
575A		ESU575, 2V/510A
576	3749	
578	2967	8020, 10CR
579B		
604	1154	PM254
610XP	3506	HY615
615		KT66
625P	1208	PM256
631	5027	5559, X61-2500
635		
635P	1208	PM256
644	670	HK645
648P1	746	
651		5552A, 656

TYPE	CV No.	EQUIVALENTS
652		5551A, 657
653B	666	9004
657		5551A, 652
672		3V/390A
673		ESU673, 2V/511A
676		3V/490A, XG2-6400
700A	689	4J42
700B	695	4J42
700C	696	4J42
700D	699	4J42
701A	677	WE, 701A
702A	678	702B
702D	2184	
703A	679	368AS
705A	3587	8021, 2T/450E
706A	3588	
707A	3589	K307
707B	1768	2K28
708A	3590	
709A	2652	
710	5234	8063, 2T1011, XR1, 1600A
710A	62	E1046
713A	3593	
714AY	2653	
715	2957	5557, X65-500
715A	2654	
715B	2655	P535/1E, 715C
715C	598	4B601E, P535/1E
717A	2594	GS1630, 713A
719A	3956	
720C	3907	
721A	3595	
722A	3596	CE302
723A	720	
723A/B	1795	KS9-20
724A	2656	
724B	1793	
725A	722	JP9-250D
726A	676	
726B	3597	
726C	3644	
729A	539	1B23
731A	850	EF95, 6AK5
732A	812	3B24
746D	2280	
800	2657	RK30
801	621	38101, WE350D
801A	621	VE310
802	622	GL802
803	623	RK28A, 38802
804	624	4052A, 5B/600A
805	625	T100-1
806	2658	GL806
807	124	QV05-25, 5B/250A, QE06/50
807W	3809	QV05-25, 5B/250A
808	626	
809	2660	NU302, HY302
810	627	WL810
811	628	GL811
811A		

TYPE	CV No.	EQUIVALENTS
812	2661	
812A		
813	26	QY2-100, C143, 5C/100A
814	629	RK47
815	2663	QQV04-20
816	724	
822	264	
825	2665	
826	630	5B/700A
828	631	3E19
829B	2666	QQV07-40
830B	702	HY513, CB30B
832	1088	832A
832A	788	QQV04-15
833	635	TY4-350
833A	635	TY4-350, ES833, 3C/402E
835	636	
837	637	RK44
838	638	HF130
841	906	1602
843	639	
845	735	T100-1
845W	3646	
846	2668	
849	2669	
849H	2670	
851	2671	
852	2672	
857		DQ7
857B	2673	DQ7
859	2779	2B26
860	640	
861	641	
863	2674	ESW872, 2V/471A
864	2675	
865	2676	
866	32	2V/400A, GU12, 3B28, AH201
866A	32	RG3-250A, 3B28, AH201, GU12
866JR	2679	2B26
868	2680	1P23, 918, CMG32
869		ESU111, 2V/540
869B	2723	DQ6, ESU111
872	642	F353, 4B32, AH217, 2V/471A
872A	1449	DQ4, 2V/471A
872AX		DGC5/5000GB
873		TQ4
874	643	3918
875A	644	
876	645	
878	2683	
879	597	2X2
880	2685	5658
884	647	
885	648	2B4
889	2686	ESW5000, 3Q/198E
889R-A	2687	ESA5000, 3J198E
891R	2688	ESW891, 3Q198E
892R	904	BR175, ESA892, 3J197E
893R	2689	
901A	1587	ECR35, 90EG4

TYPE	CV No.	EQUIVALENTS
902A	2301	
902M	2244	
902P1	3600	902P1A
904V	2690	MH41, HLA2, AC/2HL
905	736	
906	737	3AP1
906P1	602	3AP1
908A	1529	
913	2691	
918	2692	1P23
919M	420	
927	405	55CG, CMG34X
929	2693	59, 61DV3
930	2694	GS1650
930B	702	HY51B
931	2695	1P21, 27M1
931A	2696	27M1, 1P21
935	2697	
946A	1521	E4412/M9
953	738	
954	1095	ZA2, 4672
955	1039	HA2
956	649	
957	2700	
958	650	
958A	3E+06	958
959	1794	
965K	2230	
966	32	DCG4/1000G, RG3-250A, 866A
966A		DQ2
967	2957	5557, TQ2, XG5-500
972	642	TQ4
972A		DQ4
973		TQ4, 873
991	651	NE16, CD2005
994V	1037	154V
1000UHF		WL1000T
1005	2874	
1024	2634	367
1038		328
1043	1097	E4504/B/16
1048		68530
1089		1788
1139		1129
1163	2775	68506
1164		68508
1201	2704	7E5
1201A	2704	7E5
1203A	2705	1203
1229	711	32E
1231	2707	
1232	303	EF22
1240/54HM		T955Z
1240/54LM		T955Y
1240/54L2M		T955S
1252W	2464	
1257	5027	5559, XG1-2500
1267	1992	Z300T
1280		14C7
1282	902	7W7

TYPE	CV No.	EQUIVALENTS
1291	811	3B7
1294	2709	1R4, 3B7
1295		WL632B, 57, 3V/390A
1299	815	3D6
1325		1725A
1325F	8513	
1326		1010
1349		1010
1378X	761	1B22
1500T	2711	
1547	3789	IW4, R3
1561	1064	DW4-500, U14, R3, UU5
1601A	1385	E4504/B/16
1601ABC	440	
1601E	440	
1601G	6027	
1602M	1530	
1603	652	6C6
1608A	1391	E4504/E/16
1608D	1526	
1609	2712	
1610	2713	
1611	653	6F6
1612	654	
1613	655	
1614	2714	QV06-20
1616	656	
1619	723	
1620	657	6J7GT
1622	658	6L6G, 1614
1625	659	
1626	1755	
1629	1756	
1630	2715	
1637	1052	0M9, EL32
1638'	1054	EB34
1639	1055	DL36, EBC33
1642	875	2C21, RK33
1646A	966	E4504/M/16
1646G	6109	
1650/03HB		T958Z
1650/10HB		T958Z
1652M	1530	6LY1
1655	2716	6SC7
1656	932	446A/B
1658M	307	6LY1
1659	1769	2A6
1672		WL172
1701		PL5557
1708		367
1709		367
1729	2717	
1754	3518	5948
1789		1788
1805P1	832	5AP1
1806P1	817	3EP1
1807		1805
1813P7	884	7BP7, ZP468
1814P1	790	2AP1, 1814P1
1821	1443	DW2, V10, UU5, R1

TYPE	CV No.	EQUIVALENTS
18		
1823		1805
1831		1805
1851	599	GL1851
1851GT		1851
1852	660	6AC7
1853	1873	6AB7
1861	1039	IW4-500, MU14, R3
1867		IW4-350, R2, MU14, R42, UU5
1868	3759	R2, UU4, IW4/350, MU12
1876	2718	
1877	1290	HVR2
1881	3759	R2, UU4, IW4/350, MU12
1883		1882
1904		3V/390A
1907	3521	XH25-500
1908P1	1783	9JP1
1909		1909H
1909A	2291	
1924	2719	
1960	1792	5836
1971		WL207
2000	1836	68506, 1163
2000T	998	
2050	2565	EN32, 20A2, 4G/281D
2051	1798	20A2
2054		
2100A	2967	WL8020, RV12-100, 8020
2183		1164
2211BRA	439	22/11BXA
2218B	439	22/11BXA
2269Y	2463	
2273P		T938Y
2329		
2501A3	602	906P1
2505A5	740	5MP1
2511A5	741	5LP1
2529A5	1791	5JP1A
2634		4074A
3017A		4017B
3025	2722	
3041A		3041
3069		866A, DCG4/1000G, 2V/400A
3069A		4069A, 5C/101A
3069M	429	
3069Q		T939Z
3069QMM		T939Z
3070		872A, DCG5/5000GB, 2V/471A
3071	2723	869B
3072		WL857B
3073Q		T939Y
3078		DCG9/20, 6508
3209	2725	09J
3220K	954	20K
3226D	2727	26D
3226J	2786	26J
3229D	2728	29D
3263DS	2731	63DS
3530	405	55GG, CMG34X
3554		56CG
3572		866A, DCG4/1000G, 2V/400A

TYPE	CV No.	EQUIVALENTS
3861B	2519	QEL150, 4X150A, QV1-150A, 4H135M
3874A	26	QB2-250, 813, QY2-100, 5C/100A
3885		DC, X4/1000
3900A		G500/1G
3901A		G1500/1G
3903A		G1800/1G
3904A		G100/1G
3945		845
3951	2733	
3982	2680	1P23
4001AM		T4A/9AA
4001C		T4A/75AA
4001F		T4A/15AB
4001N		T4A/15AD
4003A	2743	B1C/1C
4004B	2329	B2B/2C
4005N		T4A/15DA
4006A	1600	CAT1, BW173, 3Q/181E
4006AS		B1B/1EW
4006B		B1B/2E
4007A		2W/541E
4008A	1601	AW223, CAR1, 422B, 2W/450E
4011A	1415	
4012A	1445	4094A, 3B/851A
4013C	1605	3Q/120G
4014A	1603	3Q/180E
4015A	2735	3D/150G
4017		866A
4017B	1446	2V/401C
4018G	1733	
4019A	249	3A/107A
4019B	1655	AR11, 425XD, 3A/107B
4020A	1653	AR12, 3A/108A
4020B	1657	3A/108B
4021A	1671	3A/109A
4021B	1663	AR20, 3A/1C9B
4022AR	1664	3A/110A
4022B	1659	3A/110B
4028A		
4030A	1447	4030D, 3Q/293E
4030D	1447	3Q/293E
4033A	1220	3B/252B, 61P
4033AF	2743	
4033L	1688	3B/252B, 61P
4040B	1657	3A/108B
4041		
4043C	1448	3B/351A
4045A	243	4A/137B
4046A	244	5A/128B
4047B	1600	CAT1, BW173, 4006
4049A		E1197
4049C	1355	RG3-1250, GU18, 2V/470C
4049D	5	AH221, RG4-1250, GU21
4049GD		3V/470A, 3V/490E
4050AG	2745	C16GS/2G
4052A	1081	5B/600A
4053	950	
4053A	967	
4054		
4055		



TYPE	CV No.	EQUIVALENTS
4056A	1025	DET25
4058		
4059A	1611	MR4
4060A	1030	T250, ET30
4061A	1369	5B/100A
4062A	1568	
4064A	2746	DQ4A, 872A, 2V/471A
4064B	1449	872A, DQ4, 2V/471A
4065	495	CV2269, ME, 1401
4066	2370	ME, 1402
4066A	1181	KT41, 7A3, APP4B
4068		
4069		ME, 1404
4069A	1372	RK28
4074A	18	DET19, 2C34, RK34
4074B	1573	
4077A	33	4077D, 2V/490C
4078A	1420	869B, 2V/531E
4078GA	447	
4079A		2V/561E
4080A		2V/590E
4080GA		3V/590E
4081	2749	
4081A	1797	3Q/212E
4094		3B/650A
4096AB		C1, OSS/1B
4096AG	2794	C1OSS/2G
4121A		B8B/1A
4121AA		B8B/2C
4121AB		B8B/1C
4212E		3C/201A
4220C		3Q/184E
4222B		2W/540E
4242		3B/651A
4242A	25	ES85, UE311, 3B/850A
4261	2957	5557, XG5, 500
4282		4B/70UA
4304CB		3B/503B
4304CD	1252	V1505
4311B		311B
4313C	75	313C, G150/1A
4316A	683	316A
4317	1201	317
4328A	2619	328A, 5A/136A
4328D	245	5A/136D, 328D
4357A	27	357A, ES351, 3C/357H
4378	1453	
4407	1084	
4409	995	6AJ5
4410	1087	
4412E		V1505
4502	1086	
4602	956	
4604		
4605	1085	
4606	2764	
4607	690	RK48A
4608	1511	
4671	1059	HA2, 955, ES0111
4672	1095	
4673	2765	

TYPE	CV No.	EQUIVALENTS
4690	2767	
4701A	677	701A
4702A	678	702A
4703A	679	703A
4705A	3587	705A
4706A	3588	706A
4707A	3589	707A
4708A	3590	708A
4713A	3593	713A
4717A	3594	717A
4721A	3595	721A
4722A	3596	722A
4726	676	726A
5031		872A
5121	797	2D21
5215A	1081	
5221	1835	3B28
5517	3609	CK1013
5544	2210	XR1-3200
5545	2215	XR1-6400, 5686, 3G/502A, 6807/G
5556	3640	405BU
5557	2957	XG5-500
5558		
5559	5027	XG1-2500, 571, 57, BT5
5583	405	927, 55CG
5586	3611	
5610	4058	M8080
5620		4004B
5626	298	FA15
5628	2952	FA13
5629	2662	
5632	5234	PL5632, C3J, ZT1011, 8063, XR1-1600A
5636	3928	EF730
5641	473	EY70, SN954
5642	2241	DY70
5643	474	EN70
5647	3916	
5651WA	4048	M8098, OS, 1212
5654	4010	6AK5WA, M8100
5656	2970	
5657	3958	
5663	3610	
5664	1765	3C31/C1B
5667	2687	889R
5670	4013	
5672	2238	DL620
5675	2971	
5676	2239	XFR3
5678	2254	DF60
5679	876	7A6
5684		21B12
5684/C3J/A	2753	6011
5685/C3JA	2754	CV8287
5686	3612	
5687	2578	
5691	3705	6SL7
5692	3942	6SN7, ECC33, B65
5693	3699	
5696	3512	EN92
5702	3895	5702WA

TYPE	CV No.	EQUIVALENTS	TYPE	CV No.	EQUIVALENTS
5704	2874	EA76, 6489	5962	2383	BR191
5718	3930		5963	3900	
5719	4008		5965	5843	
5725	4011	M8196	5976	5900	KS7-85A, TK61
5726	4007	EAA901S, 6AL5W, M8212	6002	3902	QK221
5727	4018	M8104	6005	4019	M8245, 6AQ5W
5734			6007		DL67
5749	4009	6BA6W	6008		DF67
5750	4012	6BE6W, EK90	6021	3986	ECC70
5751	4017	ECC, 803S, 6057	6024	3539	ATR387, TRW7
5755	3755		6027	3997	JP9-15, 2J42A
5763	2129	QV03-12, 6062	6029		CK573XA
5771		BW165	6031	5027	575559, HG1-2500
5783	3933	85A3, M8190	6038	3628	1B35A
5783WA	4066	M8190	6052	2698	5896
5784	3896	ECC70	6053		5903
5787	3897	5787WA	6056		5907
5794A			6057	4004	M8137, ECC803S
5796	3706	XR1-1600	6058	4025	QA2404, M8079, EAA901S
5799	2678		6059	4006	6BR7
5800	2730	ME1402	6060	4024	M8162, ECC801S
5814			6061	4043	6BW6, M8162
5814A	4016	5814WA, ECC802S	6062	4039	M8091, S763
5914WA	4032	5814	6063	4005	6X4WA, QA2407, M8096
5829	3898	E180F	6064	4014	S6F12, QA2403, M8083
5840	3929	EF732, 5901	6065	4015	M8161, QA2400
5842	3789	1547, 417A	6067	4003	M8136, ECC802S, 12AU7WA
5846	2859	WL5846	6073	2903	OA2WA, STU150/30, M8223
5847	3905		6074	4028	OB2WA, STU, 108/30, M8224
5852	3943		6075		KPW5/3500, CW1100, QY5-3000W
5855	5957	XR1-12A	6076	5129	KS7-85A, QB15/3500, CR1100, QY5-3001
5861	273	TD03-10G, DET22G	6077		TBW12/100, TY12-50
5866	1924	TB2.5-300, TY2-125	6079	3522	QY5-500, RS687
5867	1350	TB-3750, TY3-250	6080	2984	11D12, ECC230, 33B/160D
5868	1351	TB4-1250, TY4-500, RS631	6080WA	5008	
5870		DCG, 42003	6083		PE1/100
5876A			6084	2729	E80F
5877	2210	5544, XR1-3200	6085	5989	E80CC
5878	2215	5545, XR1-6400	6088	2699	
5886	495	ME, 1401, DF703	6095	4019	6AQ5W, M8245, 6005
5894	2797	QQV06-40A, 5894A, QQE, 06-40	6096	4010	5654, 6AK5W, 6096, M8100
5894A	424	QQV06-40A, 5894, QQZ04-50	6097	4007	M8212, 5726, 6097, 6AL5W, EAA901S
5895	1835	QQC04-15, QQZ04-15	6100	4022	6C4WA, M8080
5896	2698	6052	6101	4031	6J6WA, M8081
5899	475/7	5900	6106	2996	HL41DD
5900		5899	6111	3961	
5901	3929	5840	6117	3906	
5902	4029	EL71	6125	4022	QA2401, 6135
5903		6053	6130	3629	3C45, XH3-045
5907		6056	6131	3632	
5910		DF904	6132	4055	6CH6
5915		EH900	6135	4022	M8080, 6C4WA, QA2401
5920	5214	E90CC	6137	1993	6SS7
5923		TBW6/6000, TY6-5000W	6146	3523	QV06-20, QE03/40
5924		TBL6/6000, TY6-5000A	6155	2130	QY3-125, RS685
5932	3899		6156	2131	QY4-250, RS686
5933	3517	5B/254A	6157	2218	R17
5939	3545	WL5939	6158	4068	13D3
5948	3518	1754	6159		QV06-20C, QE05/40H
5949	3521	XH25-500	6161	3901	5580, 5946

TYPE	CV No.	EQUIVALENTS
6174		CK1027
6180	278	6SN7, QA2408
6187	4011	M8196, 5725, 6AS6W
6189	4003	12AU7WA, M8136, ECC802S
6198		P810
6199		150AVP, 6291
6201	3508	ECC801S, M8162, 12AT7WA
6202	4005	QA2407, 6063, 6203
6203	5009	QA2407, 6063, 6202
6205	2432	
6218	5724	E80T
6227		E80L
6252	2799	QQV03-20A, TT20, 55B/200A
6267	2901	EF86, Z729, 6F22
6268	1787	4C35, XH8-100
6279	2520	5C22, XH16-200
6291		150AVP, 6199, XP1060
6292		XP1090, CAV50
6305		2T/270K, R10, HR1
6308	4054	M8142
6326		P813
6346		5551A, BK42A
6347		5552A, BK24A
6348		5553B, BK146A
6354	2225	150B2, QS1200
6360	2798	QQV03-10, 11E13, TT24, 55B/100A
6363		XP1070
6370	5106	E1T
6373	2105	DL70
6374	2235	EY84, R18
6375	2275	DC70
6391	476	EF74
6410	3903	QK338
6435	372	3C45, XH3-045
6488	446	EF73
6489	469	EA76
6516	4063	M8082
6538	2236	Z800U
6539	2255	X801U
6574	2253	EN32, 21A1, 4G3200
6617		TBW12/25, TY12-25W
6618		TBL12/25, TY12-25A
6626	4020	M8223
6627	4028	OB2WA, M8224
6661		E90F
6662		E99F
6663		EAA901S
6679		ECC801S
6680		ECC802S
6681	4004	12AX7WA, M8137, ECC803S
6686		E81L
6687		E91H, EH900S
6688	3998	E180F, 5A/170K
6688WA		E186F
6689		E83F
6693		DCG6/18, RG4-3000, 2V/520A
6700	5277	ET51
6778	468	EC70
6779	2434	Z803U
6786	XG15-10	XG15-10

TYPE	CV No.	EQUIVALENTS
6807		3G/502A, XR1-6400
6844	5278	2510M
6844A		GN-4A
6850	2799	6252, QQU03-20A, TT20
6861		
6866		E702
6870	5121	
6883		QV06-20B
6883B		
6893		6883
6922	2492	E88CC
6923	5140	EA52
6939	2466	QQE02-5, QQV02-6, TT23
6960		QBW7/800, TY7-6000W
6961	5239	QBL7/800, TY7-6000A
6972		JP9-75
6975	5249	K59-30
6977	6094	DM160
7001	4067	M8167
7004		TBL2/300, TD2-300A
7007		4JC/201E
7021		5551A
7027		EL34
7028		JP9-2.5
7031		
7034	2519	QV1-150A, 4X-150A
7035	3991	4X150D, QV1-150D
7036		5915A, EH900S
7041		5553B
7062	5766	E180CC
7090		JP2-0.2
7091		JP2-2.5A
7092		TB5/2500, TY6-800, 15D12
7093		JP35-30
7118		E181CC
7119	5766	E182CC
7125		EBF89
7136		DCG6/18GB
7203		4CX, 250B
7204		4CX, 250F
7292		JP2-2.5W
7363	3706	5796, XR1-1600
7377		QQU04-16
7378		QQU08-100
7386	2215	5545.X, R1-6400
7432	4501	EF72
7433	4502	EF73
7434	4503	EF731
7435	4504	EA76
7436	4505	EF71
7437	4507	S1966
7438	4508	EF70
7475	1070	GD100B, QS92/10
7527	5959	QY, 4-400
7534		E130L
7580	2487	4X250B
7623		TT21
7632		ORP10
7633		ORP11
7634		61SV

TYPE	CV No.	EQUIVALENTS	TYPE	CV No.	EQUIVALENTS
7636		BA16-10	8269		TY8-6000A
7639		LA16-20	8270		2T1000
7641		TW59	8334		
7700	585	6C6	8348		YL1080
7709		2700W	8380		
7710	5820	2700U	8382		
7711		2701U	8408		YL1130
7713		2804U	8415		YD1110
7721		5A/185K, D34	8417		
7722		E280F	8429		YL1120
7730			8433		Z504S, ZM1070
7737		E186F	8436		EC158
7751		E235L	8437		
7753		TY6-1250A	8438		C1136
7788	5809	E810F	8441		
7804		TY8-15A	8456		
7805		TY8-15W	8532		
7806		TY12-20A	8556		EC8010
7807		TY12-20W	8628		
7854		YL1060	8808		
7870			8828		
7905			9001	1757	
7971		S11E12, L5B/280D	9002	664	GL9002
7972		13E1, 5B/900A	9003	665	
7973		S2P20, L5A/220K	9004	666	653B
7974		16P12, 3R/153S	9005	667	GL9005
7980		83A1	9006	2769	100R, WL578
7981		XR1-3200A	9549		5820
7983		QQ203-10	9901		5867
8001	824		9903		5894, B1135
8003	2768	T100-1	10667F		P813
8008		DCG5/5000GS, ESU8000	10667G		P810
8011	62	E1046	13077	2770	
8012	662	GL8012	18042		6086
8013A	716	8013	18046		IL861
8016	541	1B3GT, R6158A	38116		1163
8019		4304CB	38166		DCG4/1000G, 866A, 2V/400A
8021	3587	378A	38217	2957	5557, XG5-500
8022	934	27	38807	124	807, QU05-25
8023	933	4C3015A	55008		8153, JP35-80
8025	663	3E29	55029	2284	4J50, JP9-25
8025A	3915		55030	2284	4J50, JP9-250
8026	92	4C27	55032	3953	4J78, JP9-250A
8042		Q206-20	55125		JP2-5W
8063		2T1011, XR1-1600A, 21B12	55370		KS70-40
8078		14D12, 3C/500E	55390		2K25
8108	5397	EC157	55391		723A/B
8117		YL1070	56000	2967	8020, RY12-100
8118		QQ203-20, YL1020	56010		ME1260
8153		JP35-80	56074		VMF-4
8168		4CX1000A	56075		RMP-1
8170		4CX5000A	56150		106-12
8171		4CX10000D	56151		106-13
8177		QY3-1000A	56199		WPS-3
8179		QY5-800	68503	2773	68510
8223		E288CC	68504	2774	
8228		221000	68506	2775	1163
8233	508	E55L	68508		1164
8254		EC1000	68510	2776	
8268		TY8-6000W	68530		1048

TYPE	CV No.	EQUIVALENTS	TYPE	CV No.	EQUIVALENTS
68530/U600	3756	1048	A2293	4079	11A1, 3B/152K
178148		1163, 68506, 38116	A2327	2204	TD03-10F
180238		1164, 68508	A2426	4082	
189048	2777	1163	A2521	2453	6CR4
189049		1163, 68506	A2599	5242	
217283		1164, 180238, 68508	A2674		436A
289414		1163, 189049, 38116	A2688	4081	
289416		1163, 289414, 189049, 38116	A2744		A2521
766766		1164, 217283, 180238, 68508	A2792	6097	
859483	2779	4B36, 20X672	A2900	6091	
A11B		UU5, R2, 1W4-350, A11A	A2975	4120	
A11C		1W4-500, R3, UU5, A11A	A3065		
A11D		1W4-350, R2, UU5	A4051	124	QE06-50, QV05-25, 807
A20B		2D4A, D41, V914	A4110		A4090
A23A		TDD4, 11A1, MHD4, AC/HLDD	A4229	824	HK257A
A27D		Pen4DD	A4501		QE06-50
A30B	2806	AC/2HL, 484V, MH41	A4535		11D12
A30D		354V, MH4, HLA2, AC/HL	AA61	3884	ECC40
A36A	1424	20A1, AC/TH1, TH4, X41	ABC1		DDT2A
A36B		TH4B, 20A1, X41, AC/TH1	ABC91	452	DH77, 6AV6, EBC91
A36C		TH4B, AC/TH1	AC042	1732	PA20
A39A	1412	TV4	AC044	1168	P12/250, LP4, PP3/250, PX4
A40	2800	HA1	AC054	1168	PP3/250, PX4
A40M	1165	AC/SGVM	AC064	1168	PP3/250, PX4
A40/N3	2801		AC084	1168	PP3/250, PX4
A41	1175	ZA1, AP4	ACIS	2819	
A47-13W		CME1906	AC2/HL	2806	MH41, 904V, HLA2, 484V
A50A		SP48A1, SPT4A, AC/S2Pen	AC2/HLMet	2807	HLA2, 904V
A50B		SP4B, M5/PenB	AC2/Pen	2808	PenA4, 7A3, KT41, 42MP/Pen
A50M		9A1, VP4, VMP4G, AC/VP1	AC2PenDD	519	PT4D, DN41
A50N	1172	9A1, VP4, AC/VP1	AC4/Pen	1326	Pen4B
A50P		VP4B, W42, AC/VP2	AC5/Pen	2809	PT1, DN41
A70B		Pen4VA, 7A2, AC/Pen, N40	AC5/PenDD	1196	
A70C		PenA4, 7A3, AC2/Pen, KT41	AC6/Pen	1189	
A70D		PenA4, KT41, N41, 7A3-A70C	AC7	1683	MKT4
A70E		PenB4, AC/4, Pen	AC54	5219	QY5-3000A, 6076
A80A		FC4, 15A2, MX40	AC104	1161	104V, PP3/250
A80M	3576	15A2, FC4, MX20, X42	AC/DD	1170	SD41
A207	2160	ESU77, 25/460C	AC/DDT	2813	TDD4
A232	3587	705A	AC/HL	2811	MH4, 41MHL, HLA2, 244V
A239		3B24W	AC/HLMet	2812	354V
A373	1184		AC/HL/DD	2813	TDD4, DDT4, HD4, 11A1
A800	412		AC/HL/DDDD	2813	11A2, DDT4
A819	1698		AC/HP	1282	SP4
A901	1722		AC/L	1732	TT4, LF441FP
A915	1462		ACM3		
A915Met	2803		ACP	2815	PA1, 4MXP, 054, TT4
A915AMet	2804		AC/P	1179	ML4, 41FPTT4, 104V
A924	2805		AC/P1	1689	PA1, 054V
A1065M	1343		AC/P4	207	
A1320	51	Y65	AC/Pen	1174	7A2, Pen4VA, MKT4, MP/Pen
A1714	408		ACPT	2818	
A1744			ACPT8	2818	
A1820	409		AC/Q	1326	B4, Pen428
A1834	2523	RV12-100, 6080, 11D12, 33B/160D	AC/S	2819	
A2087	2171		AC/S2	1677	SP4, MS4B, SPT4A
A2134	2179	E2134	AC/S2Pen	1282	HP4101/7, MS/Pen, 8A1, AC5G
A2226	2231		ACS4	5219	QY5-3000A, 6076
A2244	2204		ACS5	2985	RS2793, 4CX5000A
A2272	2318		AC/SG	2822	8A1, MSP4, S4VB

TYPE	CV No.	EQUIVALENTS	TYPE	CV No.	EQUIVALENTS
AC/SG	1190	E1046	AH200	1628	
AC/SGVM	1165	AS5124, 9A1	AH201	32	ESU866, RG3-250A, 866A
ACSH	1677	S4VB, MS4B, SP4, SPT4A	AH205	2673	857B
AC/SL		SP4, SPT4A	AH211A	532	GU24
AC/SP1	2820	AC/S2Pen	AH213	2723	869B
AC/SP3	2923	TSP4	AH217	642	DCG5/5000GB, 872A, 2V/471A
AC/SP3RH	1430		AH221	5	RG4-1250, 4049D, GU21, 2V/500C
AC/S1VM	1165	VPT4	AH238	1629	RG3-1250, GU18, 2V/474C
AC/TP	1718	TP4	AHC	1039	R3, UU5, IW4/500, MUM
ACT6	2825		AK1	3576	15A2, FC4, MX40, X42
ACT9	28	BR152B, 3J/121E	AL1	159	
ACT9B	1994		AL2	375	AL2
ACT10	2827	5762, YD1120, TY6-5000B	AL13-36	5282	
ACT14		BR140	AL21-12		F21-10LD, T964Y
ACT16	1431		AL22-10	5300	2273P, 9RP33, T938Y, T956Y
ACT17	225		AL31-10		T939Y, 3073Q
ACT19	379		AL31-12		T956Y
ACT22	257		AL60	9	
ACT23	288		AL1610		F16-10LD
ACT24	240		AN1	1128	ME1502, GT1C
ACT25	436		AP4	175	XSG1.5
ACT27	2163		APP4A	1683	7A2, AC/Pen, N40, KT42
ACT28	2163		APP4B	1181	7A3, PenA4, AC2Pen, KT41
ACT28A	5326		APP4C	1684	
ACT29	6057	BR1138	APP4E		PenB4
ACT30	2383	5762	APP4G	2836	
ACT70		BR1166	APV4	1039	1W4-350, R3, UU5, MU12
AC/TH1	2830	TH4B, X41, 20A1	APV4100		1561, U12/14, DW4/500-APV4
AC/TH1A		TH41	AR10		5552A
AC/VH	3788	VP4	ARM		5551A
AC/VP	1169	ME, 1401, 5802	AR63	3710	
AC/VP1	518	VP4A/5, 9A1	AR300	2839	4212E, 3C/270A
AC/VP2	2832	VP4B, MVSPenB, W42	AS4120	1677	SP4A, MS4B, AC/SG
AC/VPB	2832	VP4B	AS4125		AC/SG/VM
AC/VS	1165		ASG04A		BL1267, Z300T
AC/Y	1174	KT427A2	ASG5017		PL5557, TQ2
AC/YY	1326	APP4E(B4)	ASG5023		PL3C23
AC/Z	1181	PenA4, PT4(F)	ASG5025		PL3C23
AD/P4	1198	ACP4	ASG5121	789	PL2D21, EN91, 2D21, 4G/280K
AF2	1169	9A1, UP4, VMP4G	ASG5696		5696
AF3	2833		ASG5823A		5823A
AF21-12		T964Z	ASG6011		PL5684, C3JA
AF22-10		T938Z, 2269P	AT4	1171	HA1, A40
AF31-10		T939Z, 3069Q	ATL1-1	2245	3J/160E
AF31-12		T965Z	ATL2-1	2905	3J/170E
AF350	1252	4212E, 14D13, 3C/270K	ATS25	124	807, QV05-25
AFH202	12	E1191	AW17-20		T943N
AFX203	2868	C1A	AW21-10		M21-10W
AFX212	1949	EN93, 6D4	AW21-80		T951W
AFX234	5023	EN93, 6D4	AW36-20		14ABP4A, C14PM
AG3B28		3B28	AW36-21		14AB4A
AG8	1057	EK32	AW36-48		T935W
AG5209	449	85A2, 0G3	AW36-80		14AMP4
AG5210	1833	108C1, 0B2	AW43-80		17BTP4
AG5211	1832	OA2, 150C2, 50C2	AW43-88		17CVP4, CME1706, C17AA
AG866A	32	DCG4/1000G, RG3-250A, GU12	AW53-80		21CLP4
AG872A	642	DCG5/5000GB	AX4/125A		6155, QB3/300
AG8008		DCG5/5000GS	AX105		PL105
AGR9950		5869	AX224	1835	DCX4/1000, 3B28, GXU1, RR3-250, 2G/402
AGR9951		5870, DCG12/30	AX228	2399	2G/473C

TYPE	CV No.	EQUIVALENTS
AX230	2518	DCX4/5000, 4B32, GXU2, RR3-1250, 2G/472B
AX9900	1924	5866, TB25/300, T350-1, TY2-125
AX9901		5867, TY4-400
AX9902	1351	5868, TB4/1250, TY4-500
AX9903	2797	5894, QQE06-40, QQV06-40A, TT25
AX9904	3926	5923, TBW6/6000, TY6/5000W
AX9904R		5924, TBL/6000, TY6/5000A
AX9905	1838	5895, QQC04/15, QQZ04-15
AX9906		6077, TBW12/100, TY12-50W
AX9906R		6078, TBL12/100, TY12-50A
AX9907		6075, QBW5/3500, QY5-3000W
AX9907R	5219	6076, QBL5/3500, QY5-3000A, ACS4
AX9908	3522	6079, QB5/1750, QY5-500
AX9909		6083, PE1/100
AX9910	2799	6252, QQE3/20, QQV03-20A, TT20
AX9911	1787	6268, 4C35, XH8-100
AX9912	2520	6269, 5C22, XH16-200
AZ1	2860	A231
AZ2	2861	
AZ12		AZ11
AZ31	2862	U143
AZ32	2861	
AZ41	3892	
B1B/1E	1600	4006A
B1B/1EW		4006AS
B1B/2E		4006B
BIC/1C	2734	4003A, 5A
BIC/1E	433	
B2A	2565	2050, 2051
B2B/1C	2743	4004A
B2B/2C	2329	4004B
B4B/1C	536	4120/AA
B6	2140	
B6E	2141	
B8B/1A		4121A
B8B/1C		4121AB
B8B/2C		4121AA
B12	494	
B12E	2142	
B21	2864	240B, PM2BA, PD220A
B24	2143	
B24E	2144	
B30	2865	
B36	925	12SN7GT
B63	1867	6A6
B65	278	6SN7GT
B109		UCC85, 10L14
B142	1927	ES833, 3C/402E
B152	455	12AT7, B309, ECC81
B217	1021	HLB1, D210
B228	1673	PM2HL
B230	1032	PD220
B240	1032	PM2B
B262	1018	Z21, S6215, S23-B255
B309	455	ECC81, B152, 12AT7
B319	5192	PCC84, 7AN7, 30L1
B329	491	ECC82, 12AU7
B339	492	12AX7, ECC83, 7025, 6L13
B442M		B442

TYPE	CV No.	EQUIVALENTS
B442S		
B719		ECC85, 6AQ8, 6L14, 6L12
B1109	2736	3C24
B1135	8479	5867, 9901, TY4-400, RS630
B1152		
B1153		
B2048		X2818
B2049		X2918
B2052T		B2047
BA9-20	2393	7635, N1010
BA16-10		7636
SAC/32		
BD78	2125	
BD302	5278	Z510M, 6844
BF61	3889	EL41, 6CK5
BF62	3890	EL42
BK24	2124	5552A
BK24B		5552A
BK34		5553B
BK42		5551A
BK44	1742	5554
BK46		5555
BK146		5553B
BK168B		5822A
BL63	1102	
BLC/1C	433	
BOL014	984	S2A
BPM04		6AQ5, EL90, N727
BR1	692	0Z4
BR29	2687	ML5667, 889
BR129	2687	ESA5000
BR140		ACT14
BR152	28	ACT9
BR152B	28	ACT9, 3J/121E
BR153	2159	ACT14
BR161	2322	
BR175	904	ESA892
BR179	2323	
BR191	383	
BR191B	5289	5762, TY6-5000B, YD1120
BR1129		3J/162J
BR1130		5736
BR1138		3J/122E
BR1160	8730	TY6, 5000B
BS4	189	
BS4A	1859	
BS5	233	
BS48	460	
BS52	1841	
BS60	527	DA60
BS62	1858	
BS64	1743	
BS82	463	
BS84	462	
BS92	461	
BS100	1219	DA100
BS1100		ES1102
BT	892	
BT5	5027	5559, XG1-2500, 57, 3V/390A
BT9	1145	

TYPE	CV No.	EQUIVALENTS	TYPE	CV No.	EQUIVALENTS
BT9A	1146		BW140	2871	CAT6
BT9B	13		BW153	2872	CAT9
BT19	1144	XG2-500	BW173	1600	3Q/181E
BT25	1147	21N13	BW175		ESW892
BT29		XG2-12	BWS1	2470	
BT35	1147	21N13	BWS2	2471	
BT45	22		BWX3	6056	
BT69		6786, DCG7/100B, XG15-12	C1A	2868	AFX203
BT75	489		C1B	1765	5664
BT77	2215	XR1-6400, 5545	C1C	1400	
BT77A		XR1-6400A, 5545	C1K	2790	
BT79	372	3C45, FX227	C3J	5234	5632, 8063, ZT1011, XR1-1600A
BT83	1120	5622, XH16-3200	C3JA	5234	5684, 8063, XR1-1600A, 2/B12
BT85	1787	XH8-100, 4C35	C6A	714	
BT91	2210	5544, XR1-3200	C6L		XR1-6400A, 6807
BT91A		XR1-3200A, 7981	C6SS/1B		VLS492AB
BT111		XR1-1600A, 8063	C6SS/1G	1527	VLS492AG
BTR32	458		C9A		CRM92
BTR34	459		C10A		BTY34
BTY27		C11F	C10B	764	UR1C, V20, 1D5, BTY36
BTY28		C11A	C10C		BTY38
BTY30		C11H	C10D		BTY39
BTY31		C11C	C10F		BTY33
BTY33		C10F	C10G		BTY35
BTY34		C10A	C10H		BTY37
BTY35		C10G	C10/SS/1B		4096AB
BTY36		C10B	C10/SS/2G	2794	
BTY37		C10H	C11A		BTY28
BTY38		C10C	C11B		BTZ18
BTY39		C10D	C11C		BTY31
BTY41		C36F	C11D		BTZ19
BTY42		C36A	C11F		BTY27
BTY43		C36G	C11G		BTY29
BTY44		C36B	C11H		BTY30
BTY47		C36D	C12/1		MW31-74
BTY50		C35F	C12A		CRM121
BTY51		C35A	C12B	2315	
BTY52		C35G	C12FM		MW31-74
BTY53		C35H	C12R	429	12AEP26
BTY54		C35C	C14/3A		AW36-20
BTY57		C40F	C14HM	3535	
BTY58		C40A	C14LM/1		T935W
BTY59		C40G	C16GS/2G	2745	4050AG
BTY60		C40B	C17-1A		MW43-69
BTY61		C40H	C17-2A		MW43-69
BTY62		C40C	C17-4A		MW43-80
BTY64		C50F	C17-5A		AW43-80
BTY65		C50A	C17-7A		AW43-88
BTY66		C50G	C17AA		AW43-88, CME1706
BTY67		C50B	C19-AK		AW47-90
BTY68		C50H	C19-7A		AW47-90
BTY69		C50C	C19-10A		AW47-91
BTY70		C50D	C19-10AP		A47-13W
BTZ18		C11B	C20C		10D1, 2D13C
BTZ19		C11D	C21AA		AW53-88
BTZ20		C35B	C21-1A		MW53-80
BTZ21		C35D	C21-7A		AW53-88
BU100/6	2867		C21KM		MW53-80
BW	1600	CAT1, 4006A	C21NM		MW53-20
BW129	2686	ESW5000, 3Q/198E	C23AK		AW59-90



TYPE	CV No.	EQUIVALENTS	TYPE	CV No.	EQUIVALENTS
C23B	3503	11D3, HLDD1320, TDD13C	CAG29	2270	90, AG
C23-7A		AW59-90	CAR1	1601	4222B, AW223
C23-10A		AW59-91	CAR4	1602	
C27D		Pen40DD	CAS1		4W20000A
C30B		HL13C, 4D1, HL1320	CAT1	1600	4006A, BW173
C35A		BTY51	CAT2	1605	
C35B		BTZ20	CAT3		BW173
C35C		BTY54	CAT6	2871	TX12-12W, BW140
C35D		BTZ21	CAT9	2872	BW153
C35F		BTY50	CAT17	533	
C35G		BTY52	CAT20C	421	BW187
C35H		BTY53	CAT29		BW1139
C36-24		MW36-24	CAV29	2132	90AV
C36A		TH21C, TH2321, 202CTH	CB215	1032	PD220, PM2B
C36A		BTY42	CB220	1696	PD220A, PM2BA, B21
C36B		TH2321, TH30C	CBC1		TDD13
C36C		TH2321, TH30C	CBL6		CBL1
C36D		BTY47	CBL31	1463	
C36F		BTY41	CC2		HL13, 4D1
C36G		BTY43	CC3D	2870	
C36H		BTY45	CC3L	2266	
C39A	2942	EM1	CC81E		6201
C40A		BTY58	CC82E		6067
C40B		BTY60	CCA	2492	E88CC, 6922
C40C		BTY62	CCE305		3V/340B
C40F		BTY57	CCT6	6016	
C50B		SP13C, 8D2, BTY67	CE1		CMG32
C50C		BTY69	CE1C	2692	918
C50D		BTY70	CE1D	2680	1P23
C50F		BTY64	CE1E		918
C50G		BTY66	CE2	1764	1P30
C50H		BTY68	CE3		1P31
C50N		9D2, VP1322, 13VPA	CE4		1P36
C70D		7D6, Pen383, Pen36C	CE5		1P35
C70E	1672	7D6, Pen3520, Pen36C	CE11V		917
C80B		FC13C, 15D1	CE20	1474	CE25, NU20
C143	26	813, QZ2-100, 5C/100A	CE21		920
C144	2666	QQV07-40, 829B	CE23		923
C178A	2797	5894, QQV06-40A, TT25	CE25	405	1P32, 927, CMG34X
C180	788	832A, QQV04-15	CE26		1P33
C200	2988	HV18, NU200, 3C/150A	CE29		1P39, 929
C203A	2986	203A, HD203A	CE31V		919
C243N	1118	KT2, PT2, 22A	CE34		934
C833		833A	CE59		5581
C866		DCG4/1000G	CE72	709	72R, 3B24
C866C		DCG4/1000G	CE91		1P37
C872		DCG5/5000G	CE225		1163
C932		P810	CE226		1163
C933		7038	CE230	819	PL33, N16
C960		5820	CE235		1164
C962		7294	CE306	2215	51CG
C1108	2130	6155, QY3-125, RS685	CE309	2957	PL5557, TQ2, XG5-500
C1111	427	5D21, 7156	CE311		PL3C23, TQ1/2
C1112	2131	6156, QY4-250, RS686	CE866		DCG4/1000G
C1123	3543	4D32	CE872A		DCG5/5000GB
C1133	2416	4PR60	CE927		3546PW/02
C1134	2799	QQV03-20A, 6252, 55B/200A	CF1		SP13, 8D2
C1136	5959	QY4-400, 7527	CF2		VP13A
C7501	2869	3JP7	CF7		SP13, 8D2
CAA322	1904		CF61		ECH41

TYPE	CV No.	EQUIVALENTS	TYPE	CV No.	EQUIVALENTS
CF141		UCH41	CR1100	5219	6076, QBL5/3500, QY5-3000A
CG1-C	425	0A74	CR1101		6181
CG1-E	425	CEX44	CRM91		C9A
CG4E		2X105G, GD5	CRM92		C9A
CG5		51CG	CRM121		C12A
CG6	405	55CG, CMG25	CRT4/1		2880
CG6-E		GD4	CRT5/1	487	
CG12-E		GD3	CTR139		872R
CG14	496		CS2-A	103	
CK1		FC13	CS2-C	1907	
CK502AX	385	DL71, 2E35	CS3-A	253	
CK505AX	443	PF70	CS3-B	1844	
CK506AX	387	DL72	CS4B	2258	
CK512AX	2107	DF66	CT1-500	1144	3V/340B, XG2-500
CK515BX		CK509A	CT1/2500		PL5559, 57, 3V/390A
CK522AX	2699	6088	CW1100		QY5-3000W, 6075
CK523AX	2106	DL66	CWS24A	1968	
CK525AX		CK523AX	CX25	1766	
CK533AX		CK532AX	CX1113	2851	3D22
CK536AX		CK535AX	CX1119	7384	
CK537AX		CK526AX	CX1120	2520	XH16-200, 5C22
CK542DX		DL650	CXT1	2389	
CK546DX		DL651	CXT2	2400	
CK556AX	2239	5676	CY1		G2080, UR1, CY2
CK549DX		DF651	CY1C		UR1C, V20, 1D5, U4020
CK707	2848		CY3		UR3
CK1003	517	0Z4A	CY30		U301
CK1005	2874	1005	CY31	1402	0M1, U201
CK1027		6174	D1	1078	T4D
CK5074WA		CK5704	D2	2778	2J21
CK5672	2238	DL620	D2M9	283	6AL5, 6D2, EB92, D77
CK5678	2254	DF60	D3A		5A/185K
CK5704	2847	5704	D4	1037	354V, AC/HL, MH4, HLA2
CK5726		5726	D41	1187	2D4A, DDL4, V914
CK5793WA		CK5703, CK5703WB	D42	557	
CK5744WA		CK5744, CK5744WB	D61	1092	EA50
CK5784WA		CK5784, CK5784WB	D63	554	6H6G, EB34
CK5886		DF703	D77	140	EB91, 6AL5, D152, 6D2
CK6135		CK6100	D143		12
CL4	2875	Pen26	D152	283	EB91, 6AL5, 6D2, D77
CL30			D210	1021	LK31
CL33	1401	332Pen	D400	1170	SD4A
CME1706		AW43-88, C17AM, 17CVP4	D418	1686	
CME1902		AW47-90, C19AK, C19/7A	DA	1109	4D1, HL1320, HL13C
CME1903		A47-91, C19/10A	DA30	563	D026, 440XP, V505, PX24A
CME1906		A47-13W	DA41	1076	TZ40
CME2302		AW59-90, C23AK, C23/7A	DA42	2394	1D13, ES1101, 3B/402A
CME2303		AW59-91, C23/10A	DA60	527	
CME2306		A59-13W	DA90	753	1A3, 1FD13
CMG8	1432	GS26	DA100	1219	ES1102, MZ-1-100, 3C/100E
CMG22	1473	52CG	DAC1	2887	
CMG25	242	5566, 927	DAC32	1818	1H5GT, HD14
CMG25	250	55CG	DAF41		DAF40
CMG25	1472		DAF70	2104	
CMG29	2133	90CG	DAF91	784	1FD9, 1S5, ZD17
CMG32	584	56CG	DAF92	3912	1U5
CMG33X	1913		DAF96	9024	1AH5, 1FD1, ZD25
CMG34X	405	55CG.927	DAG1	2	
CMV29	2134		DB3-91		1CP11
CR176	2324		DB7-5		3ALP11

TYPE	CV No.	EQUIVALENTS	TYPE	CV No.	EQUIVALENTS
DB7-18		D7-15BG	DDT4S		ABC1
DB7-36		3WP11	DDT6S	1428	EBC3
DB7-91		3AFP11	DDT13	3503	11D3, HLDD1320, TDD13C
DB10-94		4EP11	DDT13S		2D13A
DB13-10		5CLP11	DDT220		TDD2A, H2D
DB13/14		5ADP11	DDT527	6136	
DB13/34		5ADP11	DDX52	2232	
DB13-78		5BHP11	DE5	2891	
DB13-79		D13-21BG	DEQ	1156	
DB13-97		5BXP11	DER	1642	
DB13/134		5ADP11	DET1SW	2895	
DB16-22		7AHP11	DET3	1034	
DBM9-11		3AZP11	DET5	1223	
DBM10-93		4LP11	DET5B	2892	
DC2P	1735		DET6	1620	4094A
DC51	1		DET9	2899	
DC70	2275		DET10	2900	
DC80		6375	DET12	1288	4304CB, 3B/5048
DCC90	808	1E3	DET16	1363	B150
DCF60		3A5	DET18	419	35T
DCG1-250		1V6	DET19	18	RK34, 2C34, 4074A, 33A/138A
DCG1-5-250	2738	RG1-250	DET20	6	E1148
DCG4/1000ED	1625	CV1072, CV1626, GU50	DET22	273	TD03-10
DCG4/1000G	82	DQ2A, RG3-250, GU12A	DET23	354	TD03-5
DCG5-5000EG	3670	DQ2, RG3-250A, 866A, GU12	DET24	397	TD04-20
DCG5-5000GB	642	R64-1000	DET25	1025	
DCG6/18		872A, DQ4, 2V/471A	DET27R		3C/270E
DCG7-100B		2V/520A	DET28		
DCG9/20		XG15-10	DET29	2397	
DCX4-1000	1835	DQ6	DET29M	5400	
DCX4-5000	2518	3B28, DX2, RR3-250, 2G/402A, GXU1	DF1	2907	
DD4	1170	3B28, DX2, RR3-250, 2G/402A, GXU1	DF21		DF22
DD4D		4B32, RR3-1250, 2G/472B, GXU2	DF31		DF32
DD6	140	2/538	DF33	1823	1N5GT, Z14
DD6G	140	EB91, 6AL5, D77, D152, 6D2, 6AL5	DF60	2254	5678, DF61
DD13	1300	6AL5, 6D2, EB91, D77, D152	DF61	2371	6611
DD41	1403	10D1, 2D13C	DF62	2237	1AD4
DD465			DF63	2433	
DD260	2889	2D4	DF64	2260	02DF
DDA1		2D4A	DF66	2107	CK12AX
DDA41	795	V914, 2D4A, D41	DF67		6008
DDL4	1691	2D4A, D41, V914, DDA41	DF70	433	BIC/1E, CK505AX
DDL13	1695	DH30	DF72	2101	
DDPP4B		AC2PenDD, DN41, PT4D	DF73	2103	
DDPP4BM	519	27D, Pen4DD, DN41, AC/2	DF91	785	1T4, 1F3, W17
DDPP4BS		ABL1	DF92	1758	1L41F2
DDPP4M		Pen4DD	DF96	9025	1AJ4, 1F1, W25
DDPP6BS		EBL1	DF97		1AN5
DDPP6S		EBL1-0, DPP6BS	DF650		CK549DX
DDPP39		PenDD-4020	DF904		1U4
DDPP39S		CBL1	DG4-1	5131	
DDR2	173	EF55	DG7-5	2175	3ALP1
DDR3	135	EY91	DG7-6	5269	
DDR7	136	6AM5, EL91, N77	DG7-18		D7-15GH
DDT	2813	H4D, NA2, 11A1, AC/HLDD	DG7-31	5418	
DDT	2890	TDD4, H4D	DG7-32	2431	3AMP1, 5WP1
DDT2		TDD2A, H2D	DG7-32/01		3AMP1A
DDT2A		HD21	DG7-36	3946	3WP1
DDT2B	1044	HL21/DD, TDD2, HD23	DG13-2	2191	5CP1A
DDT4	2813	TDD4, AC/HLDD, MHD4, 11A1/2	DG13-34	5035	5ADP1

TYPE	CV No.	EQUIVALENTS	TYPE	CV No.	EQUIVALENTS
DG13-78		5BHP1	DL73	2299	
DG16-22	2352	7AHP1	DL74M		12Q7GT, DH76
DG736		8A1	DL75	2102	
DGP	1141	GDT4C	DL82		7B6, DH81
DH	1665		DL91	783	1S4
DH3-91	2302	1CP31	DL92	2370	3S4, 1P10, N17
DH7-11		3BYP31	DL93	2390	3A4
DH7-91	6095	AFP31	DL94	2983	3B4, 1P11, N19, 3V4
DH10-94		4EP1	DL95	818	N18, 3Q4
DH13-10	5811	5CLP31	DL96	2361	3C4, 1P1
DH13-76		5CBP31	DL98	2240	3B4
DH13-78		5BHP31	DL145		10LD11
DH13-78		DG, 13-58	DL620	2238	XFR3, 5672
DH13-79		D13-21GH	DL650		CK542DX
DH13-97	5168	5BKP31	DL651		DL650
DH30	1695	DDL13, 11D5	DLS	190	Z530331
DH42		TDD4, AC/HLDD	DLS10	979	Z530331, S60/1B
DH63	587	6Q7G	DLS15		S61/1B
DH63M	587	6Q7GT	DLS16		S62/1D
DH73		6T7, 6Q6	DLS19	342	Z530333, VLS631, S102/3K
DH73M	2909		DLS21		S62/3D
DH76		12Q7, DL74M, DH74	DLS23		S75/3D
DH77	452	EBC90, 6AT6	DLS24		S55B/1K
DH81	882	7B6	DM6	2146	
DH109		UABC80, 10LD12	DM70	2980	1M3, Y251M1
DH118		DH142, UBC41, 14L7	DM71		1M1, 1M3
DH119		10LD13	DM160	6094	6977
DH142		UBC41, 14L7, 10LD3, DH118	DN7-18		D7-15GL
DH147	1055	EBC33, 6R7G, DL63	DN7-78	5418	3BKP2
DH149	887	7C6	DN13-34	5793	5ADP2
DH150	3882	EBC41, 6CV7, 6LD3, 62DDT	DN13-76		5CBP2
DH719		EABC80, 6AK8, 6T8A, 6LD12	DN13-78		5BHP2, DN13-58
DH791		3AFP1	DN41	519	AC/2PenDD
DH817		DH150	DN143		EBL21
DHM9-11		3AZP31	DNM9-11	5883	3AZP2
DHM10-10		E10-11GH, 4UP31	D024	1040	PX25, PP5/400
DHM13-10		E13-10GH, 5DZP31	D026	1178	440XP, D026, PX25
DK1	2910		D030	1178	DA30, PA40
DK2		1AC61C2	D042		Pen4DD
DK20		GC10D	D060	1206	BS60, M205-60
DK32	1802	1X7, X14	DP4-1	5940	
DK91	782	1R5, 1C1, X17	DP7-5	5171	3ALP7
DK92	5172	1AC6, 1C2, X18	DP7-18		D7-15GM
DK96	9026	1AB6, 1C3, X25	DP7-36		3WP7
DK97		1C3, X25, 1AB6	DP7-91		3APF7
DL	1661		DP10-94		4EP7
DL2	2911		DP13-2	5157	
DL29		3D6	DP13-10		5CLP7
DL31		1A5G	DP13-34	5125	3ADP7, 5ADP7
DL33	819	3Q5GT, 3Q5, N15	DP13-38		5BHP7
DL35	1805	1C5, N14	DP13-97	5760	5BKP7
DL36	1055	1Q5GT	DP16-22	2498	3AHP7, 7AHP7
DL63	2912	6R7, DH147	DP61	850	EF95, 6AK5, PM05
DL64	2331		DP495/6		Pen4DD
DL66	2106	CK523AX	DPM9-11		3AZP7
DL68	2259		DPMIO-93		4LP7
DL69	2361		DQ5		ESU575
DL70	2105	6373	DQ2	32	GU12, 866A, 2V/400A
DL71	385	CK502AX	DQ2A	1625	DCG4/100ED, 3B28, AW201, RG3/250, GU12A
DL72	387	CK506AX			

TYPE	CV No.	EQUIVALENTS
DQ4	642	DCG5/5000GB, 872A, ZV/471A
DQ4A	3670	DCG5/5000EG, RG4-1000, 4064A, 2V/471C
DQ6		DCG9/20, 6508, 869B
DQ7		AN205
DQP	1121	T41
DQZ		DCG4/1000G
DR715C		P535/1E, 4B/603E, 4B/601E
DR813		813, 5C/100A
DR869B		ESU111
DS	2979	H30
DS103	94	
DT70	798	2E22
DT436		TDD4, AC/HLDD
DU4		DU2
DU5		DU2
DV32	88	3A/148J
DV34	127	3B/401J
DV40B	228	V246A/1K
DV55	230	V230C/1D
DV56	234	V230A/1K
DW1		DU3
DW2	1443	RV120/350, 506BU, 1821, R1, UU5
DW3		DW4-350, R2, R4, U9
DW4		DW4-500, R3, R43, U14, 1561
DW4/350	1796	RV120/350, R1, R4, R2, UU5
DW4/500	1064	RV120/500, U14, 1561
DX2	1835	3B28, ZG/402A, GXU1
DX144		EC56
DX145		EC57
DY30		1B3GT, U4-1
DY70	2241	5642, SN956B
DY80		1X2A-B, R19
DY86		1S2
DY87		1S2A, DY86
E1C	1059	HA2, 955
E1F	1095	ZA2, 954
E1T	5106	6370
E2D111		AL4
E2F	649	956
E10-11GH		DHM10-10, 4UP31
E13-10GH		DHM13-10, 5DZP31
E55L	5808	
E80CC	5989	6085
E80F	2729	6084
E80L		6227
E80T	5724	6218
E81CC	4024	6201, ECC801S, 12AT7WA, M8162
E81L		6686
E82CC		6189, ECC802S
E83CC		ECC803S
E83F		6689
E86C		EC806S
E88C		6922, 8255
E88CC	2492	6922, ECC803S
E90CC	5214	5920
E90F		6BH6

TYPE	CV No.	EQUIVALENTS
E91AA	4007	5726, EAA901S, 6ALSW
E91H	8697	6687, EH900S
E91N	4018	PL5727, 2D21W, M8204
E95F	4010	5654, 6AK5W, 6096, M8100
E99F		6662, 6BJ6
E125A		6155, Q83/300
E130L		7534
E132	1643	
E133	1645	
E180CC	8431	7062
E180F	3998	5A/170K, 6688
E181CC		7118
E182CC	5766	7119
E186F	3998	6688WA
E188CC	5354	7308, CV4110, CV4111
E250	2131	6156, QB35/750, QY4-250
E255		PM202
E280F		77225A/185K
E288CR		8223
E406N	1168	PP3/250, PX4, AC044, E406
E409N		E409
E438M		E438
E440	1282	SP4
E445M		E445
E462		E452T
E707		LK7110
E810F	5809	7788
E900		TB4/100
E902		6X4
E960	1058	VT58A
E960T	1098	E1235
E1024	1114	A373
E1046	1090	8011
E1097	1111	U27, R11, V1907
E1132	1111	V1907, U27
E1143	1577	KT44
E1148	6	DET20
E1155	44	
E1161	1253	
E1164	1091	EF50
E1180	1077	EM31
E1189	1255	
E1190	55	
E1191	12	AFH202
E1192	1501	TT11
E1197		4049A
E1198	38	
E1199	1405	
E1200		TB3/1000G
E1209	7	
E1226	15	
E1228	2	
E1229	4	
E1231	52	
E1232	92	4C27
E1235	29	
E1236	69	
E1242	1510	QV04-7, E1331
E1248	8	E1356
E1255	40	
E1267	41	
E1271	57	

TYPE	CV No.	EQUIVALENTS
E1273	58	
E1287	23	
E1289	1148	AFH202
E1297	5	AH221, GU21
E1320	51	Y65
E1323	63	
E1325	56	
E1331	1510	QV04-7, EI242
E1335	61	
E1337	78	
E1342	64	
E1355	1433	EC31
E1356	8	1248
E1359	76	
E1362	126	
E1365	114	
E1371	105	
E1373	99	
E1379	79	
E1411	153	
E1415	115	
E1416	281	X61M
E1417	117	
E1419	154	TD04-20
E1423	406	
E1429	79	
E1436	188	7475
E1453	1646	
E1457	257	ACT22
E1458	178	XD60
E1459	174	
E1465	236	
E1468	172	
E1474	78	
E1481	192	
E1485	807	3A4, DL93, 3V4
E1487	208	
E1494	191	
E1495	259	
E1496	240	ACT24
E1497	215	
E1511	355	
E1516	221	TTR31
E1524	338	
E1527	290	
E1531	214	
E1532	1644	
E1541	1716	
E1563	1863	5Z46, R52
E1591	181	ECC32
E1599	272	KR6/4
E1606	278	B65
E1633	456	
E1647	288	ACT23
E1648	135	EY91
E1659	543	12SK7
E1706	437	KT67
E1714	408	A1714
E1769	397	DET24
E1860	240	ACT24

TYPE	CV No.	EQUIVALENTS
E1935	415	TT15
E1938	493	6X4, U78
E1954	25	ES85, 4242A, 3B/850A
E1955	797	2D21, EN91, 4G/280K, PL2D21
E1956	261	2T/270K
E1959	495	ME1401, VX32
E1996	436	ACT25
E2004	2115	1B3GT
E2016	1758	EF92, 6CQ6, 9D6, W77
E2018	454	6BA6
E2095	471	EL70
E2133	2276	2319
E2134	2179	
E2157	455	ECC81, 12AT7, B309
E2163	491	ECC82, 12AU7, B329
E2164	492	12AX7, ECC83, 6L13, B339
E2221	2277	
E4103/B/4	1522	
E4103/E/4	2205	
E4205/B/7	1588	ECR30
E4025/C/7	1525	
E4412/B/9	1587	ECR35
E4412/C/9	2301	902A
E4412/E/9	1529	
E4412/M/9	1521	
E4504/B/16	1385	
E4504/C/16	1517	09D
E4504/E/16	1391	90E64
E4504/M/16	966	
EA50	1092	6D1
EA52	5140	6923
EA53		
EA76	469	6489
EAA91	283	6AL5, EB91, D77, 6D2
EAA901S		5726, M8212, EAA90
EABC80		6AK8, 6LD12, 6T8, DH719
EAC91	137	
EAF41	3883	EAF42
EAF42	3883	6CT7, WD150
EB1		
EB34	1054	6H6, D63
EB41	3881	
EB91	140	6D2, D77, D152, DD6
EBC3	1428	
EBC21	347	
EBC33	1055	OM4, DL63, 1639
EBC41	3882	6CV7, 6LD3, DH150, 62DDT
EBC80		6BD7
EBC81		6LD13, 6B07A, EBC80
EBC90	452	6AT6, DH77
EBC91	2526	6AV6, DH77
EBF2	2925	
EBF32	501	3CV01
EBF80		6N8, ZD152, WD709
EBF81		6AD8
EBF83		6DR8
EBF89		6DC8, 6FD12
EBL31	2926	
EBL181	2926	3A/167M
EC20	5112	
EC31	1433	

TYPE	CV No.	EQUIVALENTS
EC50	2927	
EC52	1137	RL16
EC53	1197	RL18
EC54	66	RL37
EC55	273	5861, TD03-10G, DET22G
EC57		EC56
EC70	468	6778, 6K4
EC71		5718
EC80	1886	6Q4
EC81	1868	6R4
EC86		6CM4
EC90	133	6C4, L77
EC91	417	6AQ4, 6L34
EC92		6AB4
EC94		6AF4
EC95		6ER4
EC97		6FY5
EC157	5397	8108
EC158		8436
EC1000		8254
EC1031		EC1030
ECC31	1285	6N7G
ECC32	181	6SN7GT, 13D2
ECC33	2821	6SN7
ECC35	569	
ECC40	3884	
ECC81	455	12AT7, B152, B309
ECC82	491	12AU7, B329
ECC83	492	12AX7, 6U3, 7025, B339
ECC84	5281	6CW7, 6L16
ECC85		6L12, 6AQ8, B719
ECC86		6GM8
ECC88	5358	6DJ8
ECC89		6FC7
ECC91	858	6J6, 6101
ECC180	5365	6BQ7A
ECC189	5331	6ES8
ECC230	2984	6080, 11D12
ECC801S	4024	6201, M8162, 12AT7WA, ECC801
ECC802S	4003	6067, M8136, 12AV7WA, ECC802
ECC803S	4004	6057, M8137, 5751, ECC803
ECC804	5264	6GA8, 6/30L2
ECC960		E90CC
ECC962		E92CC
ECF80	5215	6BL8, 6C16
ECF82	5065	6U8
ECF86		6HG8
ECF804	5948	
ECF805		6GV7
ECH3	2929	
ECH22	302	
ECH33	2930	
ECH35	1347	6K8, X61M
ECH41		CF61
ECH42	2888	6CU7, 6C9/X150, 6C10, 62TH, ECH42
ECH43		ECH42
ECH71		ECH21
ECH80		6AN7
ECH81	2128	6AJ8, X719, 6C12
ECH83		6DS8
ECH84		6JX8
ECH113		ECH42

TYPE	CV No.	EQUIVALENTS
ECL80		6AB8, LN152, 63TP
ECL82	9167	6BM8, 6PL12
ECL84		6DX8
ECL85		6GV8
ECL86	8297	6GW8
ECR30	1588	701A
ECR35	1587	901A, 90EG4, E4412/B/9
ECR57	1587	
ECR60	1097	1601A
ECR75	1787	4C35
ED2		6AL5
EE17	2957	5557, XG5-500
EE866		DCG4/1000G
EE8020	2967	
EF1		EF6
EF2	1427	EF9
EF5		EF9, EF8
EF8	1713	EF9, EF5
EF9	1427	EF8, EF5
EF9N		EF9
EF22	303	7B7, W143, 7G7
EF36	1056	0M5, EF37A
EF37	358	5A/157D, 0M5B, EF36
EF37A	5080	0M5, EF36
EF39	1053	6K7GT
EF40	3885	
EF41	3886	6CJ5, W150, 6F16, 7F16, 6ZVP
EF42	3887	Z150, 6F13
EF50	1578	Z90
EF51	1035	QP, QTT2
EF53	1136	
EF54	1136	
EF55	173	
EF70	467	6487
EF71	475	5899
EF72	465	5840
EF73	466	6488
EF74	476	6391
EF80	1376	6BX6, Z152, Z719, 64SPT
EF81		6BH5
EF82	2127	6CH6
EF85	1375	6BY7, 6F19, W719, 6F26
EF86	2901	6267, 6F22, 6CF8, Z729
EF89	5156	6DA6
EF89F		6DG7
EF91	138	6AM6, 6F12, SP6, Z77, 8D3
EF92	131	6CQ6, 6F12, 9D6, VP6, W77, 6F21
EF93	454	6BA6, W727
EF94	2524	6AU6
EF95	850	6AK5, DP61
EF96		6AG5
EF97		6ES6
EF98	8694	6ET6
EF183	5831	6EH7, 6F29
EF184	5810	6EJ7
EF730	3928	5636
EF731	477	5899
EF732	3929	5840
EF734	2432	6205
EF762		EF734

TYPE	CV No.	EQUIVALENTS
EF804S		EF800
EF861	3998	E180F, 6688, 5A/170K
EF905	4010	M8100, 5654
EFF51		EFF50
EFP60	5108	
EH90		6CS6
EH900S	8697	E91H
EHA5000	2687	889R, 5667
EHM2	2139	
EHT1	19	V1901
EHT7		
EHT15		ESU15
EHW3000	2686	889, ESW5000
EHZ350		3C/750G
EK2	1426	
EK32	1057	
EK90	453	6BE6, X77, X727, 5750
EL1-1C		3B22
EL1C		3B22
EL2	1429	EL1
EL3		EL3N
EL3/375		EL3
EL3C		
EL3N	822	EB24
EL3NS		EL3
EL5B	2936	4B22
EL11N		EL11
EL22	304	7B5, KT81
EL31	2888	
EL32	1052	0M9, 1637
EL33	2938	6AG6G, KT61, 6P25
EL33A		EL33
EL34	1741	6CA7, KT77
EL35	1269	6L6G, KT66, 5881, 5932
EL36	2940	6CM5
EL37	586	6L6, KT66
EL38N	450	6CN6, EL38
EL41	3889	6CK5, N150, 67PT
EL42	3890	N151
EL50	2941	
EL70	471	5902, SN947D
EL71		5902
EL80		6MS
EL81P	2721	6CJ6, EL820, EL81
EL82		6DY5
EL83	2726	6CK6
EL84	2975	6BQ5, N709, 6P15
EL85	3526	6BN5
EL86	5094	6CW5
EL90	1862	6AQ5, N727
EL91	136	6AM5, 7D9, N77
EL95	8458	6DL5
EL360	5830	EL36, 11E14, 5B/102D
EL820	2721	6CJ6, EL81
EL821	2127	6CH6, 7D10
EL822	2382	
EL861		E81L, 6686
ELC3J	5234	TX2/3, 5632, 8063, ZT1011, XR1-1600A
ELC6J		5632
ELC6J/A		TX2/6, 5684, XR1-6400A, 6087
ELL8		6HU8
ELP73		

TYPE	CV No.	EQUIVALENTS
EM1	2942	
EM2		
EM4	1434	
EM31	1077	
EM34	394	6CD7
EM35	1103	6U5G, Y61, 6M1
EM72		
EM80	1352	6BR5, 65ME
EM81	5055	6DA5
EM84	5434	EM840, 6FG6
EM87		6HU6
EM91	797	2D21, 20A3
EM840		EM84
EN30	2349	
EN32	2253	6574
EN70	474	5643, ME1500, SN949
EN91	797	2D21, 20A3, 4G280K
EN92	3512	5696
EN93	1949	6D4
EQ80		6BE7
ES15	3853	RS15
ES40A	2563	204A
ES85	25	4242A, 242C, UE311, 211, 3B/850A
ES204A	2563	204A
ES207	3850	RS207
ES250M	1618	TZZ-250
ES253	3851	RS253
ES357	27	357A, 4357A
ES450	1207	
ES833	635	833A, TY4-350, 3C/402A
ES1001		3D/162E
ES1101		3B/402A
ES1102		3C/100E, BS1100
ES1500	1614	MT13
ES1500A	1614	MT13
ESA891	2688	891R, 3J/196E
ESA892	701	892R, 3J/197E
ESA892C	904	892R, BR175
ESA1500		3J/167E
ESA2500		16J12
ESA5000	2687	889R, 5667, 3J/198
ESG250	1031	SG250, 4C/252G
ESP450	1506	5C/450A
ESU15		EHT15
ESU74	74	V1922, 2T/460C
ESU75	2945	
ESU76	2943	2V395C
ESU77	2160	A207, 2S/460C
ESU101		2V301B
ESU103	1835	3B28, 2G/402A, GXU1
ESU107		2V/521A
ESU111		F369B, WL-869B
ESU112		2S/460A
ESU115		2V/302B
ESU150	2946	2V/461C
ESU200	5	4049D, GU20/21, RG4/1250
ESU208	1260	
ESU300	2947	AH221, GU21
ESU450	1259	
ESU575		F375A, DQ5



TYPE	CV No.	EQUIVALENTS	TYPE	CV No.	EQUIVALENTS
ESU866	32	DQ2, 866A, RG3-250A, GU12, 2V/400A	F/6063	4001	6X4WA
ESU866ES	1625	RG3-250	F/6064	4002	M8140
ESU872	642	DQ4, 872A, 2V/471A	F/6067	4034	M8144
ESU1500	2944		F/6132	4056	6CH6, 6132
ESU8008		DCG5/5000S, 2V/471B	F/6158	4069	13D3, 6158
ESV4002		3Z/252E	FA13	2952	5628
ESW501	1621		FA14	2953	5629
ESW1500		3Q/167E	FA15	298	5626
ESW5000	2686	889, 3Q/198E	FC2	1043	210PG, X22
ET3	451	1B3GT, R6158A	FC2A	2954	VHT2A, X22, FV2A
ET30	1030	T250	FC4	2955	15A2, V04, MX40, VHT4, 41MPG
ET51	5277	6700	FC13C	2956	V013, 15D1
ET1000		TB4/800	FG17	2957	5557, TQ2, XG5-500
EW2A	2139		FG27A	2958	873, BT5
EY51	426	6X2, R12, SU61, U43, U151	FG57	5027	57, 5559, XG1-2500, BT5
EY70	473	SN954, 5641	FG67	742	1267, 5728
EY80		6U3	FG105		105, XGQ2-6400
EY81	5905	6R3	FG154		3V/390B
EY82		6N3	FG235A		PL5552A
EY84	2235	6374, R18	FG238A		PL5553B
EY86	2966	6S2	FG271		PL5551A, BK42C
EY87		6S2A	FP54	2960	5740
EY88		6AL3	FVD7	404	HR7
EY91	135		FW4/600	1264	RV200/600, U18/20
EZ2		EZ1	FW4/800	31	U20
EZ4		EZ3	FX42		XL611
EZ22	346	7Z4	FX215	2203	GHT1
EZ35	574	6X5GT, U147, GW5, U70	FX219	2520	5C22, XH16-200
EZ40	3891	6BT4, U150, UU9, 88KU	FX225	1787	4C35, XH8-100
EZ41		EZ40	FX227	372	3C45, XH3-045
EZ80	1535	6V4	FX229	3521	6949, XH25-500
EZ81	5072	6CA4, U709, UU12	FX231	2993	XH16-200, 5C22
EZ90	493	6X4, U78	FX290		8503
EZ91	135	6AV4, EZ90	FY		PM24M
EZ9000			FZ9011G	2270	90AG, CAG29
F2	2338	1923	FZ9011V	2132	90AV, CAV29
F21-106C		T964Z	FZ9012G	2133	90CG, CMG29
F21-10LD		T964Y	FZ9012V	2134	90CV, CMV29
F31-10LC		T965Z	G	988	
F31-20LD		T965Y	G1/235G	3524	
F60		1163	G1/371K	2224	
F123A	2949	T100-1	G5A-1200		QS1218/1200
F129B	2950	129B, 3P/270B, 3Q/191E	G5A-1600		QS1218/1600
F228	734	228A	G5A-2000		QS1218/2000
F353	642	872A, A4217	G5H	2247	
F353A	642	872A, DQ4, 2V/471A	G/6C4	4058	M8080
F366A	32	866A	G-9		WL868, 918
F369B		ESU111	G10H	2173	MX103
F375A		ESU575	G10HE	2287	
F443N		F443	G10/241E	2223	
F869B	2723	869B	G12H	2287	
F872A	642	DQ4, 2V/471A, 872A, F353A	G14		WL920
F872B	642	4B32, 4064B	G15F	1913	WL927, CMG-33X
F892R	904	892R	G20/5D		DQ6
F/5726	4049	M8180	G24	411	
F/5654	4050	M8180	G24E	2148	GM5B
F/5750	4037	5750	G24H	2147	
F/6057	4035	M8214	G48		1163
F/6060	4033	M8144	G49		1163
F/6061	4045	6BW6, 6061	G50/1G	2208	

TYPE	CV No.	EQUIVALENTS	TYPE	CV No.	EQUIVALENTS
G60E	2149	G60E	GD120A/S	1110	S130
G75/2D	3798	VR75/30	GD120A/S	45	S130P
G75/3G	4030	QS75/60	GD120A/S	110	MN3
G105/1D	686	VR105/30	GD120M		MN5
G108/1K	1833	0B2, QS1208	GD120T		MN6
G120/1B	438		GD150A/S	216	0D3, 150C3, 0B3, G150/3D
G150/1A	75	4313C, 313C	GD150M		150C4
G150/2D	216	0D3, QS150-40	GD150M/R		ST7
G150/4K	1832	0A2, 150C2, QS1207	GD150M/S	1832	150C2, 0A1, QS1207
G155/1C		2	GD150P	2225	ST9
G160/1C		1	GD150P/S	2225	QS1200, 150B2
G180/2D	2029		GD340W		CS1
G180/2G			GD350X		CS2
G180/2M	395	QS150/45	GD350Y		CS2
G210/1C	212		GDT4B	1141	
G240/2D	2174		GET2	743	V611, NE2
G279/1C		1A	GEX36	2279	
G400/1K	2194		GEX45/1	425	2X106G, GD4
G400/2G	4047		GEX54	448	OA71, GD5
G409		G407	GEX64	2310	
G431		DW2, 1821	GEX66	2290	
G445B	1651		GEX402	2902	
G470		DW2, 1821	GEX541	5104	
G500/1G		3900A	GHT1	2203	FX215
G837			GHT2	2418	
G1000/1G		3904A	GHT4	6026	
G1054		G470	GHT5	6118	
G1064		G470	GHU4	5405	
G1500/1G		3901A	GL1		
G1800/1G		3903A	GL-75/30	3798	VR75/30
G2080		CY1, UR1C	GL446	3725	GL446A
G4120		DW4-500	GL446A	932	
G4120N		IW4-500	GL446B	687	
G4150		G2004	GL455	2789	9LP7
G4300		G4180	GL464	3604	2C43, 464A
GA5A	2647	532	GL464A	688	464A
GC10A	2199		GL471A	3586	1B21A
GC10/2P		MN2	GL532	2647	532
GC10B		DK-1	GL572	2516	2C39A, 3H/151J
GC10B/S	2271	Z303C, 6482	GL592	1903	592
GC10/4B	1739		GL806	2658	806
GC10B/4B/L	6100		GL868	2680	868, 1P23, 918
GC10B/L	6044		GL869B	1420	2V/531E
GC10D	5143	DK20	GL889R	2687	889R
GCA10G		DK-10	GL892R	904	892R, BR175
GC12/4B		DK3	GL918	2692	918
GD2V		SP1	GL927		3546PW
GD83M		83A1, 7980	GL2050	2565	2050, B2A
GD85M/R		RF2	GL5720	5027	XG1-2500, 5559
GD85IV1/S	449	QS1209, 85A2, QS83/3	GL8020	2967	8020, 8023
GD85PR/S	4048	QS1212, M8098	GL8023	933	15E, 8023
GD85WR		RF4	GLE10000/025/1	1625	DCG4/100ED, RG3-250
GD86E/S	2321	RF1	GLE1000/3/12		RG4, 3000, 6693
GD86W	2321		GLE1300/1.5/05	642	872A, CV1449
GD86W/S	2321		GLE20000/2.5/10		6508, DCG9/2
GD87M	2573	5651	GLY1		1652M
GD90M	5173	QS1215, 90C1	GM1B	2149	G60E
GD100A/S	188	7475, QS90/10, ST11	GM4	2138	
GD100B/S	1070	7475, QS92/10	GM5	411	
GD108M	1833	0B2, QS1208, 108C1	GM5B	2148	G24E

TYPE	CV No.	EQUIVALENTS
GM255/1D		22M1
GN-4		Z520M
GN-6		XN3
GN24		DW2, 1821
GPE175M		
GR1		TV801
GR2G		MN7
GR2H		MN8
GR4G		MN9
GR10A		Z503M
GR10H		MN11
GR10K	5842	RG8
GR10W		MN12
GR12G		MN13
GR12H		MN13
GS-4		Z521M
GS10C/S	2325	Z502S, 6476
GS10D		DK13
GS10E		MN14
GS12D		DK12
GS16S0(80-110)	2694	930
GS16/160	248	CMG22/160
GS16(80-110)	1473	CMG22, (80-110)
CS18	242	CMG25
GS26	1432	CMG8
GS46	584	PE7B
GS47X	405	3546PW, 927, 55CG, CMG34X
GS50	2133	90CG
GS118	1801	
GS146	2692	918, CMG32
GS544X	1913	
GSA10G		DK10
GT1	2969	849
GT1A	1143	ME1502
GT1C	1128	ME1502, AN1
GT1E	530	
GT3		
GT11	435	
GTE120Y		TR7
GTE130T	2434	Z803U, 6779
GTE175M		TR1
GTE20000/2.5/10		6508, DCG9/2
GTP-1		NE1000
GTP-2		NE1004
GTRY5M/S	284	75P1
GTR75M	284	ST11
GTR83W		RF-8
GTR83X		RF-7
GTR95M/S	286	SM95, QSP5/10, 95A1
GTR120A/S	45	S130P, QS150/15, 150B3
GTR150M/S	287	SM150
GTR150W		RF-9
GU1	1262	RG1-250
GU5	1072	MU4250
GU7	2973	
GU8	1628	
GU11	532	AW205
GU12	32	DQ2, 866A, ESU866, RG3-250A

TYPE	CV No.	EQUIVALENTS
GU18	1629	RG3-1250, AH238
GU20	1435	AH211
GU20/21	5	RG4-1250
GU21	5	4049D, ESU200
GU23		2V/474C
GU50	1072	RG1-240A, ESU101, 2V/307A
GWP-1	498	NE14
GWP-2	395	NE17
GWP-3	360	NE18
GWP-4	263	NE19
GX4W	4005	6063
GX402	2902	
GXU1	1835	3B28, RR3-250, 2G/402A
GXU2	2518	4B32, RR3-1250, 2G/472B
GXU3	2399	AX228, 2G/473C, RR3-1250A
GXU4		RR3-1250B
GXU4/1000		DCX4/5000
GXU5		
GXU6	5968	
GXU50		
GXU52	338	
GZ30	2748	5Z4GT
GZ31		5U4G
GZ32	593	5V4, 54KU, 5AQ4
GZ33	5745	53KU
GZ34	1377	5AR4, 5U4, GZ33
GZ37	378	53KU
GZ41		GZ40
H2	2977	PM2HL
H2D	1044	TDD2A, 210DDT, HD24
H4D	2813	11A1, AC/HLDD, TDD4, MHD4
HMD		
H12	2978	
H20		R2018
H30	2979	D5
H42	1182	HL4G
H45	372	BT79, 3C45
H63	1073	6F5G
H210	1673	PM2HL
H410	2981	
H610	2982	
H2018D		H1918D
H4115D		H4111D
H4128D		H4111D
HA1	1171	A40, AT4
HA2	1059	955, 4671
HAA91		12AL5
HABC80		19T8
HAD	1419	11D3, HL/DD/1320
HBC80		19T8
HBC90		12AT6
HBC91		12AV6, 12BK6
HCC85		17EW8
HCH81		12AJ8
HD14	1818	1H5G, DAC32
HD21		DDT2A
HD22		TDD2A, H2D
HD23		TDD2A
HD24	2985	TDD2A, H2D, 210DDT
HD30		3B4

TYPE	CV No.	EQUIVALENTS	TYPE	CV No.	EQUIVALENTS
HD51		0A2	HP210C	1322	SP210, HP210
HD52		0B2	HP211C		HP211
HD93		1X2	HP215	1322	SP210, Z21
HD94		6BQ6GTB, 6CU6	HP415	1169	9A1, VMP4G
HD203A	2986	203A	HP4101	1124	
HF61	3886	6F15, EF41, 6CJ5	HP4101C	1282	SP4, 8A1, SPT4A, AC/SG
HF62	1839	6F13, EF42	HP4105	1169	VP4
HF93	1928	12BA6	HP4106	1169	VMP4G, 9A1
HF94	1961	12AU6	HP4115	1169	MV5Pen, 9A1
HF100	2987	4C22	HP4115C		HP4105
HF121		10F9, UF41	HR1		R106305
HF130	638	838, RK58	HR2	261	R10, 2T/270K, 6304
HF150		T100-1	HR5		HR4
HF175		T100-1	HR7	404	FVD7
HF200	2988	3C/150A	HR21	1673	HL210, PM2HL, HL2
HF300	693		HR210	1673	PM2HL
HG2		DQ2A	HSD	1695	11D5, DH30
HG25	32	866A	HT7		XG5-500
HK24	941	25T, 3C34	HT415	3540	5C22
HK24G	789	3C24, 25TG	HV18	2988	HF200, NU200
HK54	707	4C25	HV951	1420	2V/531E
HK90		12BE6	HVR1	1290	U16, 1877
HK254E	2989		HVR2	1134	SU2150A
HK257	824	4E27	HY51B	702	830B, UE930B
HL2	1673	PM2HL, 210HF	HY61	124	807
HL2Met	2991		HY75	751	
HL2K	1050	PM2HL	HY90		35W4
HL4	1173	354V	HY114B	3505	
HL4G	1182	H42	HY615	3506	615, Det20
HL4X	1037	41MTL, ACHL	IFW1	1039	1W4, 431U
HL13	1109	4D1, HL1320, HL13C	IL861		18046
HL13C	1109	4D1, HL1320	IW2		R21881
HL21	1303	PM1HL	IW2A		
HL21DD	1044	TDD2A, H2D, 210DDT	IW3	1039	IW4-350, R2, 1867, UU5
HL23	1130	3A/205D	IW3-350	1039	APV4, R1, UU4, MU12
HL23DD	2995		IW4	1039	R3, UU5
HL41	24	3A/204D	IW4/350		IW3
HL41DD	2996		IW4/500	1039	APV4, R3, UU5, MU14
HL90		19AQ5	J231AAA		1163
HL92	1959	50C5	JN2-2.5A.5A		7091
HL94		30A5	JN2-2.5W		7292
HL133	2998		JNT1-500	3602	5J26
HL133DD	2999		JP2-0.2		7090
HL135		HL135	JP2-2		7091
HL210	3500	PM2HL, HL21	JP2-2-5W		7292
HL210A	1303		JP2-5		7028
HL610	3501		JP8-02B	6072	
HL1320	3502	HL13C, 4D1	JP9-2.5		7028
HLA1	2806	AC/2HL	JP9-7	3676	MAG3, 2J42
HLA2	1678	354V, AC2HL, 41MHL	JP9-7A	370	M508
HLB1	1021	210LF, DZ10, HL2	JP9-7D	1866	M503A
HLDD/1320	3503	DDT13, 11D3, 13DHA	JP9-15	3997	MAG4, 2J42A, M513B
HM04		6BE6, EK90, X77	JP9-15D	5123	
HM71			JP9-50	2852	2J56
HM85			JP9-50B		2J49
HN309		PCL82	JP9-50C		2J50
HP2	1032	220B, PM2B, PD220	JP9-75		6972, M575
HP6	138	EF91, 6AM6, 8D3Z77	JP9-80	3569	4J52A
HP13	1106	9D2, VP1322	JP9-80A	5018	4J52A
HP13S		VP13A	JP9-180	2373	

TYPE	CV No.	EQUIVALENTS	TYPE	CV No.	EQUIVALENTS
JP9-250	2284	4J50A	K1678		K1658
JP9-250A	3953	4J78	K3103	8793	
JP9-250B	2426		K814024	3514	
JP9-250C	2427		KB2	3515	
JP9-250D	2425		KD21	3789	0A3, VR75/30, G75/2D, QS75/40
JP9-250E	2424		KD24	686	0C3, VR105/30, G105/1D, QS1206
JP9-250F	2473		KD25	216	0D3, VR150/30, G150/3D, QS150/40
JP28-20.2		7090	KK2	3516	
JP35-30		7093	KL35	768	1F5
JP35-80		8153	KM84		
JPG9-02C	5443		KR3	218	
JPT9-01	2420		KR6/1	116	
JPT9-02	2421		KR6/2	237	
JPT9-02E	6114		KR6/3	238	
JPT9-60	3560	2J51A	KR6/4	272	
K2		DCG4/1000ED	KRN2	87	
K3A	410		KRN3	217	
K30K		K30C	KS7-85		2K26
K7RF4	1808	2J32	KS7-85A	5900	5976
K23B		TD2A, H2D, 210DDT	KS9-20	1795	723, A/B
K30A		PM2HL, HL21	KS9-20A	2792	2K25
K30B	3531	L2, PM2DX, L21	KS9-20D		723A/B
K30C		PM2HL, 210HF	KT2	1118	PM22A, Pen220, 220DT
K30D		PM2HL	KT8	1079	
K30E	3532	L2, PM2DX, L21	KT8C	1079	KT8
K30G	3620	PB1, P220, PM2A, PL2	KT9-150W		55395
K30K		PM2HL, HL21	KT24	1334	PM22A, PT2, Pen21
K33A	1032	PD220, PM2B	KT30	3519	
K33B	1696	PD220A	KT31	3520	N31
K40B	1018	SG215, PM12A, S21-24	KT32	1287	25L6
K50M	3787	VP210, VP2, VP21	KT33		25A6G
K40N		PM12M, V52	KT33C	1503	
K50N		VP2B, VP210	KT38	1576	VT75A
K70B		PM22A, Pen220, PT2, 2200T	KT41	1181	7A3, AC2Pen, 42MP/Pen
K70D	3578	PM22D	KT42	1174	7A2, AC/Pen
K77A		QP240	KT44	1577	VT75A
K77B		PQ22B, QP21	KT44T	1576	VT75A
K80A		FC2, 210PG, VHT2A, X22	KT45	1825	KT44
K80B		FC2A	KT61	1438	6AG6, EL33, N147, 6P25
K301	2161	RX3-120	KT63	1186	6F6G, N63
K302	2164		KT66	1075	EL37, 6L6G
K305	2263		KT67	437	
K307	1871	707B	KT71		50L6GT
K308	2283		KT81	885	7C5, EL22
K312	2273		KT88	5220	12E13, 6550, 7D11
K322	2791		KTW61	1100	6S7
K324	2304		KTW62	1100	
K329		Z211/1G	KTW63	1195	6K7, 6U7, W63
K335	2343		KTW73	1056	0M5, EF36
K345D		KS6-1000D	KTW73M	3527	
K345E		KS6-1000E	KTW74M	918	12K7, W76
K345F		KS6-1000F	KTZ21	1320	SP210, Z21, SP2
K345Z		KS7-1000Z	KTZ41	3529	
K376		4KM100LA	KTZ63	1074	6J7G, Z63
K377		4KM100LF	KTZ73M	3530	
K435-10		LP4	KU25	2993	5C22, FX219, FX231
K931/A	6142		KU45	3875	
K1051	2849		KY50		U25
K1105P2	3736		KY80		U26
K1668		K1658	L2	3531	PM2HL, 270LF

TYPE	CV No.	EQUIVALENTS	TYPE	CV No.	EQUIVALENTS
L2/B		PM2HL	M503D	1866	2J42, JP9-70
L3A/167M			M505	1747	
L4	2815	AC/P, TT4, SP2	M506A	3982	MAG11
L5A/170K			M507	69	
L5A/201K	4064	S6F33	M508	370	JP9-7A, MAG3
L5A/202F	4083	S6F33F	M509	3976	
L5A/210K	4040	S6F17	M510	1827	2J32
L5A/210F	4041	S6F17F	M511	3953	4J78, JP9-250A
L5A/220K	4097	S2P20	M512	1828	2J36
L5B/280D	4060	S11E2	M513	3528	
L21	3532	PM2HL, 21OLF	M513B	3997	JP9-15, 2J42A
L21DD	1308	TDD2A, H2D	M518A	1997	
L22DD	3533		M519	1484	CV1483, CV5, CV6
L30	3534		M521	2376	
L63	1067	6J5G	M523	2412	
L77	133	EC90, 6C4	M525	2365	
L102/2K		16STE	M526	3676	2J42, JP9-7
L210	1021	PM2HL	M528	1497	CV1495toCV1500incl.
L410	1152	L410, PM4DX	M529	2426	
L600	3537	L600N, 6C22	M536		4J43, 4J44
L610	3538		M537	2281	K308
L3168		M5003	M538A	2473	JP9-250F
LA9-3B	6087		M539	2425	
LA16-2C		7639	M541		5J26
LD210	502	21OLF, D210	M542	3611	5586
LD577		T965Z	M542A		5586A
LD657		T964Y	M543		7182
LDR03		ORP12, RPY25	M548	5031	
LDR03		RPY25	M549	2424	
LG210	1021	D210, L210	M551	3569	4J52A
LL2	1732	PM2HL, L2, LL21	M559		8356
LL4	1689	PA1, AC/P, 104V	M575		JP9-75, 6972
LL4C	207	AC/P4	M589		8357
LN119		UCL82, 10PL12, 50BM8	M8079	4025	6058, QA2404
LN152		ECL80, 6AB8, 63TP	M8080	4058	6100, 6C4WA
LN309	5144	PCL83	M8081	4031	6101, 6J6WA
LN319		30PL1	M8082	4063	6516, QA2402
LP2	548	220, L2, 220PA	M8083	4014	6064, S6F12, QA2403
LP2	1023	PM202	M8091	4044	6443
LP2(Selected)	1304	L2, 220	M8096	4039	6062
LP4	1168	AC044, PP3/250, PX4	M8097	4059	
LP220	1166	LP2, PM2A, L2	M8098	4048	QS1212
LS5	1637		M8099	4070	6AQ4
LS5A	1650		M8100	4010	5654, 6AK5W, 6096
LS5B	2846		M8122	4007	5726, 6AL5W
LS5X	1667		M8124	4035	F/5750
LS6A	3541		M8136	4003	6067, 12AU7WA
LS7	1660		M8137	4004	6057, 12AX7WA
LS8	1656		M8140	4002	F/6064
LS8A	1676		M8141	4036	F/8141
LS9B	1658		M8142	4054	QS1213
LS408A	3536	53A	M8144	4033	F/6060
LS532	3542		M8149	4034	F/6067
LS650	391	5B/252M	M8157	483	QV04-7
LS731	273	DET22, ME1001	M8161	4015	6065, QA2400
LZ319		PCF80, 9A8, LZ329, 8A8, 30C1	M8162	4024	12AT7WA, 6060, QA2406
LZ329		30C1, PCF80, LZ319, 8A8, 9A8	M8163	4104	
M2H	2886		M8167	4067	7001
M6	2145		M8179	4076	6J2, ECC91
M215H	177		M8180	4050	F/5654
M500	353				
M501	76				
M501A	3660				
M502	2166	JP9-250, 4J50A			
M502A	2373	JP9-180			

TYPE	CV No.	EQUIVALENTS	TYPE	CV No.	EQUIVALENTS
M8190	4066	5783WA	ML5667	2687	5667, 889R
M8195	4085		MM4V	1165	AC/SG, VMS4B
M8196	4011	5725, 6AS6W	MM13-10	5164	5DHP32
M8204	4018	5727, 2D21	MP31-55	2314	C12R, 12AEP26
M8206			MP/Pen	1683	Pen4VA, AC/Pen, KMT4, 7A2
M8208			MPT4	1174	Pen4VA, 7A2, ACPen, MP/Pen
M8212	136	QA2402, 5726	MPT4K	3552	
M8214	4035	F/6057	MPT42	2554	111A
M8216	3987	5644	MR4	1611	
M8223	4020	0A2WA, QS1210	MR10	34	
M8224	4028	0B2WA, QS1211	MR75	1142	
M8225	4080	75C1	MR300	3557	
M8232	5029	6J4WA	MR300E	3558	
M8234	5082	5725, 6AS6W	MS4	1164	AC/SG
M8237	4049	F/5726	MS4B	3533	SP4, AC/SG, SPT4A
M8245	4019	6005, 6AQJ	MS4C		SP4, SPT4A
M8248	5311		MSG/HA		SP4, MS4B, AC/SG
MAG3	3676	JP9-7, 2J42	MSG/LA	1677	SP4, AC/SG, MS4B
MAG4	3997	JP9-15, 2J42A	MSP4	1282	SP4, MSPen, 8A1, AC/SG
MAG8	2380		MSP41	3562	
MAG11	3982	M506A	MS/Pen	3561	SP4, 8A1, AC/SG
MB13-1	5070	5FP11	MS/Pen(Clear)	1124	SP4, 8A1
ME4S	1412	TV4	MS/Pen(5Pin)	244	4046A
ME6S		TV6	MS/PenA		SPT4A
ME41	3565		MS/PenB	1125	
ME1001	273	TD03-10, DET22	MS/Pen/T	1129	MS/Pen
ME1005	354	TD03-5, DET23	MT4	1610	
ME1100	1795	KS9-20, 723A/B	MT9F	1439	
ME1101	3676	2J42, JP9-7, MAG3	MT9L	1440	
ME1101A	3997	JP9-15, 2J42A	MT11SW	3563	
ME1101D	1866	JP9-7D	MT12	3564	
ME1400	432		MT12A	1441	
ME1401	2269	5802	MT13	1614	ES1500A
ME1402	2730	5800	MT14	1442	
ME1403	2348	5886	MT16	1030	ET30, T250
ME1500	474	EN70, 5643	MT17	2957	5557, XG5-500
ME1501	2253	6574, EN32	MT57	5027	5559, XG, 1-2500
ME1502	1128	AN1	MT105		105, XGQ2-6400
ME1503	1787	XH-100, 4C35	MT5544	2210	5544, XR1-3200
ME1504	5027	XG1-2500, 5559	MT5545	2215	5545, XR1-6400
ME1505	1144	XG2-500	MT5557	2957	5557, XG5-500
MF13-1	3959	5FP7A, T923Z	MT5559	5027	5559, XG1-2500
MF22-22	3999		MU1	3567	
MF22-75	2372		MU2	1459	
MF31-55	429	C12R, 12AEP26, 3069M	MU12	1039	IW4-350, R2, R42, UU5, 1867
MF31-95	2328	12T03A, PenT139	MU12/14	1039	IW4-500, UU5, MU12
MG13-10		5DHP1	MU13-38		T929B
MG13-11	2497		MUM	1039	R3, UU5, IW4/500
MG13-38		TY29G	MU4250	1072	GU50, RG1-240A
MH4	1037	354V, AC/HL, HLA2	MV6-5	1976	
MH4Met	399	NR31	MVSG	1165	AC/SG/VMS4B, S4VA
MH41	1505	HLA2, AC2/HL, 484V	MVSPen	3571	VMP4G, 9A1, AC/VP1
MHD4	3546	DDT4, ACHL/DD, DDT	MVSPenB	3572	AC/VP2, W42
MHL4	1038	41MLF244V	MW6-2	1737	3NP4
MHLD6	1101		MW13-35	5389	5FP4A
MHT4	2955	FC4	MW13-38		T929W
MKT4	1683	Pen4VA, 7A2, ACPen, MP/Pen	MW13-75		5FP4A
ML4	1732	PA1, TT4, AC/P	MW18-2		CRM71
ML6	1105		MW22-3		CRM92, CRM92A
ML869		ESU111	MW22-22	3999	

TYPE	CV No.	EQUIVALENTS
MW31-16		C12FM
MW31-74		12XP4A, C12FM
MW43-69		17BQP4, C17/1A
MW50-23		21CJP4
MW53-80		C21/1A, 212K, 21CLP4, G21KM
MW100	25	ES85, 4242A, 3B/850A
MX1	1515	
MX2	418	
MX40	3576	V04, 15A2, 7AHP1, FC4, X42
MX52	306	
MX57	209	
MX103	2150	
MX105	2151	
MX107	2152	
MX108	2153	
MX113		18513
MX114		18514
MY3-275	1252	212E, V1505
MY13-38		T929R
MZ05-20	3573	
MZ05-60	1206	BS60, DA60
MZ1	25	ES85, 242C
MZ1-75	444	
MZ1-76	3574	
MZ1-100	1219	DA10, ES1102, 3C/100E
MZ2-200	200	
N1-1		GN-5, GN-1
N14	1803	DL35, 1C5, GWP-1
N15	819	3Q5, DL33
N16	819	DL33, 3Q5
N17	820	DL92, 1P10, S34
N18	818	DL95, 3Q4
N19	2983	DL94, 3V4, 1P11
N25		DL96, 3C4, 1P1
N30	1425	7D5, PP13A
N31	3520	KT31
N40		7A3, MKT4, AC/Pen
N41	1181	PenA4, 7A3, AC2Pen, PT4, 42MP/Pen
N43	1657	40223, 3A/110B
N63	1186	GF6, KT63
N6b	586	EL37
N77	136	EL91, 6P17, 6AM5, N144, 7D9
N78	3/11	6BJ5
N118		N145, 10P13
N119		UL84, 10P18, 45B5
N142	1977	UL41, 45A5, 451PT
N144	136	EL91, 6AM5, N77, 6P17, 7D9
N145	1977	10P13
N147	2938	6AG8, EL33, KT61
N148		7C5, ELL22, KT81
N150	3889	EL41, 6CK5, 67PT
N151	3890	EL42
N152	5077	PL81, 21A6, N359, N339
N153		PL83, 15A6, N309
IN154		PL82, 16A5, 30P16, N329
N155		EL85
N308		30P4
N309		PL83, 15A6, N153
N329		N154, PL82, 16A5, 30P16
N339		PL81, 21A6, N152, N339
N359	5077	PL81, 21A6, NL52, N359

TYPE	CV No.	EQUIVALENTS
N369		PCL82, 16A8, 30P12
N379		PL84, 15CW5, 30P18
N709	2975	EL84, 6BQ5, 6P15
N727	1862	EL90, 6AQ5, BPM08
N1022M		6861
N1031	5401	
N1032	5402	
NE2	2976	VG11, GET2
NE16	651	GL991, CD2005
NE17	359	GWP-2
NE18	360	GWP-3
NE19	263	GWP-4
NE1000		GTP-1
NE1004		GTP-2
NHP1	310	
NIX2		N359
NL715	2957	PL5557, XG5-500
N022M		6861
NP90	3607	
NSP1	220	631P1
NSP2	2296	
NSS43		NSS42
NT2	2213	CC3L
NU1	2680	918, CMG-32, PJ23
NU20	1474	CE20, CE25
NU40T2	1076	DA41, T240
NU75H	751	HY75
NU114B	3505	HY114B
NU200	2988	HY18
NU615	3506	615
054V	1698	PA1, ACP/1
0202		FC4
0406		FC4, VHT4
01307		FC13
01A		01
01B		01
OA2	1832	6073, 150C2, STV150/30
OA2WA	4020	6073, M8223, QS1210
OA3	3798	VR75-30, QS75/40
OA4	752	
OA4G	1992	Z300T
OA70	8243	1N87
OA73	442	1N616
OA79		1N541
OA79-2		1N542
OA81	448	GEX59, GEX55
OA85	1354	1N478
OA86		1N480
OA87		1N490
OA91	7130	1N617
OA95	7041	1N618
OB2	3799	VR90-30, STV, 108/30, 180C1
OB2WA	4028	6074, M8224
OB3	3799	VR90-30
OC2		
OC2.5	1607	
OC3	686	VR105-30, QS1206
OC16		2N115
OC45	5105	GET873, TK30C
QC70	5457	2N279



TYPE	CV No.	EQUIVALENTS
OC71	7005	2N280
OC72	7006	2N281
OC72-2		2N282
OC73	5337	2N283
OC76	8541	2N284
OD3	216	VR150-30, 150C3, QS150/40
OE3	431	85A1
OF1		657
OG3	449	85A2, QS83/3
OM1	1402	CY31, U281
OM3	1054	EB34
OM4	1055	EBC33, 6R7, DL63
OM5	1056	EF36
OM5A	358	EF37
OM5B	5080	EF37A
OM5C		OM5
OM6	1053	EF39
OM7		EF39, OM6
OM8	1057	EK32
OM9	1052	EL32, KT61, EL32
OM10	1581	6K8GT, ECH3, PX61M
OOA		OO
OP41		PenB4, AC4Pen
OP42		PenA4, AC2Pen, PT4
ORP10		7632
ORP11		7633
ORP90		RPY12
OS20		6474
OS20F		7294
OS40F		7293
OSW260		OSW2190
OSW2601		OSW2192
OT400	635	ES83/3
OZ4	517	1003
OZ4A	517	CK1003
OZ4QA	692	1003
P2	1246	PM202, P220A
P2-12		QGE04/20, 832A
P2-40B		829B
P4	1168	AC044, PX4
P6	1836	1163
P12/250	1168	AC044, LP4, PP3/250, PX4
P15		1164
P27/500	1040	PP5/400, D024
P41	1408	
P57	1466	
P61	1066	
P120-1A	26	813
P215	1019	215P, PM2
P220	3620	220PA, L2
P220A	1023	PM202, P2
P240		PM202
P410	3621	P410PM4X
P415	1154	PM254
P425	1154	PM254
P435		PM24M
P435/1E	398	715B
P440N		Pen4VA
P441N		Pen4VA
P460	1168	PX4, AC044, LP4, P11/250, 4XP

TYPE	CV No.	EQUIVALENTS
P495	1181	PenA4, PT4
P535/1E	398	C1111, 715B, 4B/603E
P552/1E	427	5D12, C1111, 4B/602E
P610	3622	P610
P625	1208	625P
P807		7293
P807EE		7293/E
P809		7294
P809/E		
P810		6198
P811		7295
P811/E		
P813		6332
P816		5820A
P816/E		5820A/E
P817		6474
P822/E		7389/E
P841		8507
P842		8541
P882		7389
PA1	1689	104, 3B/100B, AC/P1, 054V
PA20	1732	ML4, ZP, AC042
PA40	3623	V503, D030
PA5021		DCG4/1000G, 866A, 2V/400A
PABC80		9AK8
PB1		
PC86		4CM4
PC95		4ER5
PCC84	5192	7AN7, 30L1, B319
PCC85		9AQ8
PCC88		7DJ8
PCC89		7FC7
PCC189		PCC88
PCF80	8433	30C1, 9A8, LZ319, LZ329, 8A8
PCF82		9U8A
PCF86		7HG8
PCF200		
PCF201		
PCF802		9JW8
PCF805		7-GV7
PCH200		
PCL82		16A8, 30PL12
PCL83	5144	LN309
PCL84		15DQ8
PCL85		18GV8
PCL86		146W8
PCL200		
PCL801		30PL1
PCL805		
PD22A	1163	
PD220	1032	220B, PM2B
PD220A	1696	B21, 240B, PM2BA
PD500		9E4D
PE7	3624	GS46
PE8	3625	VS18BO
Pen4DD	519	DDPP4M
Pen4VA	1174	APP4A, 7A2, AC/Pen, MKT4, MP/Pen
Pen4VB		PenA4, 7A3, AC2/Pen, KT41, PT4
Pen13C	889	7D8, Pen1340
Pen20		PP2018
Pen25	65	

TYPE	CV No.	EQUIVALENTS	TYPE	CV No.	EQUIVALENTS
Pen31	3578	PM22D, KT4	PM2BA	1163	B21, PM2B
Pen36A	1672		PM2D	3531	L2, L21, PM2DX
Pen36C	1672	7D6, Pen383, Pen3520	PM2DL		PM2HL
Pen40DD		DDPP39M	PM2DX	3645	PM2HL, L2, L21
Pen44	3630		PM2HL	1050	HL2K, HLB1
Pen45AN	1407	Pen45	PM3	1151	L410, 410LF
Pen45DD	3631		PM4DX	1152	410LF, L410
Pen46	1127		PM12	1018	215SG, Z21, S23
Pen220	1118	PM22A, KT2, PenB1	PM12A	1018	SG215, S23
Pen220A	1051	220PT	PM12M	1041	220VS, VS2, W21
Pen231	3633	PM22D	PM12V	319	VS24, S215VM
Pen383	1456	7D6, Pen36C	PM14	1159	S410
Pen428	3634	AC4/Pen, B4	PM22	3649	220PT
Pen1340	3635	7D8, Pen13C	PM22A	3647	KT2, Pen220, PT2, 2200T
Pen1346	3636		PM22D	3578	KT2A, Pen31
Pen3520		7D6, Pen383, Pen63C	PM24A	1167	PT4, PenA1
PenA1	1181	PM24M, PT4	PM24B		PM24C
PenA4	3638	APP4B, 7A3, AC2/Pen, KT41, PT4	PM24D	1237	PM24C
PenB1	1118	PM22A, KT2, Pen220, PT2	PM24E	3648	PT25
PenB4	3626	GS46, AC4Pen	PM24M	1181	PenA1, PT4
PenDD			PM202	185	P220A, P2
PenDD4020		DDPP39M	PM252		P220A, P2
PF818		30F5	PM254	1153	
PJ8	3640	5556	PM256	1208	625P
PJ23	3680	1641, CMG32, NU1	PMT58		T935W
PK150	150		PMT62		T935W
PL17	2957	TQ2, XG5-500, 5557	PMT63		T935T
PL21	797	TQ2, 2D21, EN91, 4G/280K, PL2D21	PMT64		T952T
PL36		25E5, 30P4	PP2		PM22A, Pen220, PT2
PL57	5027	XG1-2500, 5559	PP3/250	1168	AC044, PX4, LP4
PL81	5077	21A6, N152, N359	PP4		PM24M, Pen, A1, Pen425
PL82		16A5, 30P16, N154, N329	PP5/400	1040	P27/500, PX25, D024
PL83		15A6, N309, N153	PP6/400		PX25
PL84		15CW5, N379, 30P18	PP6AS		EL2
PL105		105, XGQ2-6400	PP6BG		EL33, KT61, 6P25, 6M6
PL255		XG2-12	PP6BS		EL3
PL260		XG2-25	PP12A	1425	7D5, N30
PL345	372	3C45, XH3-045	PP13A		7D5, N30
PL435	1787	XH8-100, 6268, 4C35	PP24S	2875	CL4
PL500		27GB5	PP35		7D6, Pen383
PL509			PP36	1672	
PL522	2520	5C22, FX219, XH16-200, PL5684	PP60	1075	KT66, EL37
PL802			PP220		PM202
PL1267	1992	1267, Z300T, 0A4G	PP222	1118	KT2, Pen220
PL5544	2210	5544, XR1-3200	PP225	1051	Pen220A, PM22C
PL5545	2215	5545, XR1-6400	PP2018		Pen20
PL5632	5234	C3J, 8063, 2T1011, XR1-1600A	PSV13		2S/570E
PL5684	5234	C3JA, 8063, 2T1011, XR1-1600A	PT2	1118	PM22A, KT2, Pen220, 220T
PL6011	5234	C3JA, XR1-1600A, PL5632	PT4	1181	7A3, PenA4, AC2Pen, PT41
PL6574	2253	6574, EN32	PT4D		DN41, AC/2PenDD
PM04	454	6B16, EF93, W727	PT5	3652	
PM05	850	6AK5, EF95, DP61	PT5E	3579	
PM07	138	6AM6, EF91, E8D3, 0A240	PT6	3653	SW75Pen
PM1A	2977	PM2HL	PT10	2809	AC/5Pen
PM1HF	1673	PM2HL, 210HF, HL2	PT11	3654	
PM1HL	3641	HL2, 210HL, HL21	PT15	1104	SW40Pen
PM1LF	3642	HLB1, D210	PT25	1046	PM24E
PM2	1019	215P, 220P	PT41		PM24M, PenA1
PM2A	3643	LP2, L2, PB1, P220	PT41B		PM24
PM2B	1032	220B	PT240	3649	PM22

TYPE	CV No.	EQUIVALENTS
PT425	3656	
PT425X	1167	
PTA	889	7D5, N30
PTS	3520	N31
PTT2025		PTT202
PTT122P		PTT120P
PTZ	1672	7D6, Pen36C
PV05-15	3657	
PV1-35	3658	
PV4		DW4-350, R42
PV25	3752	U30
PV29S		UR2
PV30	3758	UR3C
PV30S		CY2, UR3
PV47S		PV430
PV/100/2000		PV4
PV495	1443	DW2, 1821, U10
PV4200		DW4-500, 1561
PV4201		
PV4300		
PX4	1168	AC044, LP4, PB3/250, 4XP, P460
PX5	1040	420XP, D024, PX25
PX25	1040	P27/500, PP5/400, PX5, D024
PX25A	3623	PA40, D030, DA30, V503
PX41	1168	AC044, LP4, PX4, 4XP
PX230		PM202, LP2, P2
PY3-600	1373	
PY31	3753	25Z4, U31
PY313		U291, PY32
PY80		19X3, U152
PY81		17Z3, U153, U329
PY82		19Y3, U192, 19SU, U319, U154
PY83		17Z3
PY88		30AE3
PY301		U191
PY50DA		
PY801		PY800
PZ1-35	1240	
PZ1-75	1221	SW75Pen, PT5E
PZ30		R14
QA75/40	1895	STV70/60
QA2400	4015	6065, M8161, 6CQ6
QA2401	133	L77, 6C4, M8080, 6100
QA2402	136	N77, EL91, M8082, 6516
QA2403	4014	M8083, 6064, S6F12
QA2404	4025	6058, EB91, 6D2, 5726, M8079
QA2405	415	44A/160M
QA2406	4024	M8162, 12AT7WA, 6060, 6201
QA2407	4005	6063, 6X4WA
QA2408	3942	5692
QB2-250	26	813, QY2-100, 5C/100A
QB3-200	1905	4-65A, QY3-65
QB3-300	2130	6155, C1108, Q160-1, RS685, QY3-125
QB3-300GA	2963	4-125A
QB3.5-750		6156, C1112, Q400-3, RS686, QY4-250
QB3.5-750GA	2964	4-250A, Y4-250B
QB3-1750		6079
QB4-1100	5959	7527, QY4-400
QB4-1100GA	3879	4-400A, QY4-400B
QB5-1750		6079
QB5-2000		QY5-800, 8179

TYPE	CV No.	EQUIVALENTS
QBL3.5-2000		QY3-1000A, 8177
QBL4-800		QY4-500A, 4X500A
QBL5/3500	5219	6076, ACS4, CR1100, QY5-3000A
QBW5/3500		6075, CW1100, QY5-3000W
QC05-35		8042, QZ06-20
QE03-10	2129	5763, QV03-12
QE04-10	309	QV04-7, CV1510
QE05-40	3523	6146, QV06-20
QE05-40F		6883, QV06-20B
QE05/40H		6159, AV06-20C
QE06-50	124	5B/250A, 807
QE08-200		7378, QV08-100
QEL1/150	2519	4X150A
QF196	1078	D1, 2B36
QK26	1768	707B
QK221	3902	6002
QK283	3685	
QK284	3886	
QK338	3903	6410
QK353	3737	
QK533		N1034
QK610		N1010
QMG159	2874	1005
QP21	1035	240QP, QP230, QP321
QP22A		QP240
QP22B	1035	QPT2, QP230, 240QP
QP25	556	
QP230	1035	QP22B, 240QP
QPT2	1035	240QP, QP230, QP2V, QP21
QQ206-20		
QQC03-14		7983, QQZ03-10
QQC04-15	1838	5895, QQZ04-15
QQE02-5	2466	6939, QQV02-6, CV5473, TT23
QQE03-20	2799	6360, QQV03-10, TT24
QQE04-5		C1134, 6252, TT20, 55B/200A
QQE04-20		
QQE06-40	424	
QQE08-12	2798	5894, C178A, QQV06-40A, 55B/400A
QQE08-12		TT23, QQE02-5, 6939
QQE08-12		11E13, TT24, 5360
QQV03-20	2799	6252
QQV03-20A	2799	QQV03/20, TT20, C1134, 6252, 55B/200A
QQV04-15	788	832AC180
QOV04-16		7377
QQV04-20	2663	815
QQV06-40	424	5894
QQV06-40A	2797	QQV06-40, TT25, C178A, 5894, 55B/400A
QQV07-40	2666	829B
QQV07-50	5847	
QQV5-P10	2295	3E29
QQZ03-10		7983
QQZ03-20		8118, YL1020
QQZ04-15	1838	5895
QQZ06-40		YL1030
QS70/20	284	75B1, STV70/20
QS74-40	3798	VR75/30
QS75/20	284	75B1, STV70/20
QS75/40	3798	6939, VR75/30, 0A3, G751
QS75/60	434	
QS83/3	449	85A2, QS1209, 5651
QS88/3		

TYPE	CV No.	EQUIVALENTS	TYPE	CV No.	EQUIVALENTS
QS92/10	188	7475	R3/10	95	
QS95/10	286	95A1	R3/16	96	
OS105/45	422		R4	1796	DW4-350, R2
QS108/45	422		R4A	1074	DW4-500, R3, UU5, 1561
QS150/15	287	SM150, 150A2, 150B3	R6A	2775	1163
QS150/30	216	OD3, 150C3	R10	261	2T/270K, HR2, 6305
QS150/40	216	VR150/30, 0D3, 150C3, G150/3D	R11	1111	U27
OS150/45	395	BS54, G180/2M	R12	426	EY51, 6X2, SU61, U43
QS150/50	287	SM150, 150A2	R12A	426	EY51, 6X2
QS1200	2225	6354, 150B2	R14		PZ30
OS1202	4052		R15A		1164
OS1203	4053		R16		1T2, U37
OS1204			R17	2218	6157
QS1205	3798	VR75/30, 0A3, G75/2D	R18		R17
OS1206	686	VR105/30, 0C3, G105/1D	R19		1X2B
OS1207	1832	0A2, 50C2, G150/4K	R20		2J2, U26
QS1208	1833	0B2, 108C1, G108/1K	R41		DW4-500, 1561
QS1209	449	85A2, 63	R42		R41, IW4-350, UU5, 1867, R2
QS1210	4020	M8223, 0A2WA	R43	1039	IW4-500
QS1211	4028	0B2WA	R52	1863	5Z4G, GZ30, U50, 5Y3
QS1212	4048	M8098	R121	5080	EF37A
QS1213	4054	M8142	R125N		R125C
QS1215	5173	90C1	R126N		R126F
Q/U456	4117		R144	138	6AM6, 6F12
QV03-12	2129	5763	R186	2235	EY84, 6374
QV04-7	309		R243		EC55, 5861, DET22
QV04-7R	483	M8157	R265	2522	6AS6
QV05-25	124	807, 5B/250A, QED6-50	R290		K81A
QV06-20	3523	6146	R612G	597	2X2A
QV06-20B			R1169		XL601
QV06-20C			R2018		H20
QV08-100			R4410	521	
QV1-150	2519	4X150A	R6010	2353	
QV1-150A	2519	4X1, BOA, 4H/135M	R6015	2354	
QV1-150D	3991	4X150D	RDM61		T953Z
QV1-150G	3893	4X150G	RDM62		T953S
QV20-P18	2752	4PR60A	RDM68		T954S
QX21	797	2D21	RDM69		T955Z
QY2-100	26	C143, 813, 5C/100A	RDM70		T955S
QY3-65	1905	4-65A	RDM71		T969S
QY3-125	2130	6155, C1108, RS685	RDM72		T969Y
QY3-125B	2963	4-125A	RE614		LK4101
QY3-1000A		8177	RENS1274		RENS1264
QY4-250	2131	6156, C1112, RS686	RENS1820		RENS1819
QY4-250B	2964	4-250A	RENS1824		X2818
QY4-400	5959	C1136, 7527	RENS1834		X2918
QY4-400B	3879	4-400A	RENS1884		RENS1818
QY4-500A		QBL4/800, 4X500A	RG1-125	1263	
QY5-300W		CW1100	RG1-204A		MU4250
QY5-500	3522	6079, RS687	RG1-240	1626	GU50
QY5-800		8179	RG1-240A	1072	ESU101, 2V/301A
QY5-3000A	1098	ACS4, CR1100	RG1-250	3667	DCG1-250
QY5-3000W		CW1100, 6075	RG3-250	1625	DQ2A, ESQ866, GU12A
QYS50-P40	313		RG3-250A	32	866A, GU12, DQ2
QZ06-20	6123	8042	RG3-1250	1629	DCG4/5000, GU18, 2V/474C
R1	1443	APV4, U10, UU5, 506BU	RG3-1250A		GU21
R2		IW4-350, MU14, R42	RG4-1000	3670	
R2/10	97		RG4-1250	5	GU20/21, AH221, 4049D, 2V/500C
R2/38	98		RG4-3000		6693, 2V/520A
R3	1039	R2, IW4-500, UU5, MUM	RG5-500	1349	4064A

TYPE	CV No.	EQUIVALENTS	TYPE	CV No.	EQUIVALENTS
RG5-12GC		6786, DGG7/100B	RS726		BR1161
RG250-300	1625	RG3-250	RS826		BY1161
RG250-1000	1072	RG1-240A, CV1626, CV2738, GU50	RS1002		QB4/1100, RS868
RG250-3000	1625	RG3-250R, RG3-250A, 866A, CV32	RS1002A		7527, QY4-400
RG1000/3000	1449	DCG5/5000GB, DQ4, 872A	RS1006B		RS614
RGN1064		RGN1054	RS1007	1924	6155, QB3/300, QY3-125, RS685
RGN4004		G4004	RS1009	2797	5894, QQV06-40A, TT25
RGQ21.4/0.4		RG105	RS1013L		TBL12/50
RHK6332		723A/B	RS1013W		TBW12/50
RK18		T50-1	RS1018	1351	TY4-500, 5868, RS631
RK20		4052A, 5B/600A	RS1019	2799	6252, QQV03-20A, TT20
RK20A	704		RS1026		5867, TY4-400, RS630
RK25		4061A, 5B/100A	RS1029	2798	6360, QQV03-10
RK28	3672	4069A, 5C/101A	RS1036		TY5-500
RK28A	3673	803	RS1041V		RS867
RK30	2657	800	RS1041W		RS537
RK31	3674		RS1046		7092, TY6-800
RK33	875	2C21, 1642	RS1061		5868, TB4/1250, TY4-500
RK34	18	4074A, 3AA/138A, DET19	RS2001N		RS865
RK38	2591		RS2001W		RS565
RK47	3677	814	RSQ15/5		TQ6
RK48		813, P120-1	RV18		3C/150A
RK48A	690		RV120/250	1064	DW4-500, 1561
RK51		T50-1	RV120/350		DW4-350, U14, R4, 1561
RK49	3679	807	RV120/500		DW4-500, U14, UU5, 1561
RK57	625	805, T100-1	RV200/600		U18/20, FW4-500, FW4-800
RK60	3680	1641	RX3-120	1261	
RK62	3681		RX120A		1164
RK63	2589	250TH, HK454H	RX233	3688	2C33
RK807	124	807, QV05-25	RX233A		693, 2C33
RK6112	2116		RX235	709	72, 3824
RKR47	3683		RY12-100	2967	8020
RKR72	709	72, 3B24	RZ		UR1C, 1D5, CY1C, U4020
RKR73	2543	73	RZ1-150	3690	
RL7	1136	EF54	RZ1-250	2853	
RL16	1137	EC52	S1M2	2134	90CV
RL17	2957	5557, XG5-500	S1M5	2155	C512BR
RL18	1197	EC53	S1.5/80DV		5552A
RL21	797	2D21, EN91, 20A3	S2	1018	215SG, Z21, PM, 12
RL37	66	EC54	S2A	984	
RL57	5027	5559, XG1-2500	S3A	374	
RL105		105, XGQ2-6400	S4V		SP4, AS4120
RL255		XG2-12	S4VB	1677	MS4B, SGA1, AC/SG
RL256		XG2-25	S5A/180	5035	DG13-34, 5ADP1
RL1267		1267, Z300T	S6F12	4014	
R0423		R0337	S6F17	4040	L5A/210K
R0446		RGN1054	S6F17F		
RR3-250	1835	3B28, ESU103, GXU1, 2G/402A	S6F33	4064	L5A/210K
RR3-1250	2518	4B32, GXU2, 2G472B	S11A		DW2, 506BU, 1821, RGN1054
RR3-1250A	2399	2G/473C, GXU3, AX228	S11D		DW4-350, R2, R4
RR3-1250B		GXU4	S11E2	4060	
RS103L1		TBL12/50	S13A	3694	
RS384	1506	5C/45A	S15/5D		TQ6
RS566		3Q/31OE	S19G6F		S19G6
RS613	1924	5866, TB2.5/300, TY2-125	S23	3691	215SG, Z21
RS630	8479	5867, TB3/750, TY4-400	S23Met	3692	SG215, Z21
RS631	1351	5868, TB4/1250, TY4-500	S24	1018	Z21, 215SG
RS685	2130	6155, QB3/300, QY3-125	S25A	16	3A/145J
RS686	2131	6156, QB3.5/750, QY4-250	S26A	53	3A/146J
RS687	3522	6079, QB5/1750, QY5-500	S27A	82	3A/147J

TYPE	CV No.	EQUIVALENTS	TYPE	CV No.	EQUIVALENTS
S28A	88	3A/148J	SCR77		C35C, BTY54
S30/2K		6N030T	SCR78		BTZ21, C35D
S30A	127	3B/401J	SCR93		BTY95-100R
S30C		AC044, 2P4, 4XP	SCR94		BTY95-150R
S30D	1732	PA20, AC042	SCR95		BTY95-200R
S55B/1K		DLS24	SCR96		BTY95-250R
S60/1B	979	DLS10, Z530331	SCR97		BTY95-300R
S61/1B		DLS15	SCR112		C50F, BTY64
S62/1D		DLS16	SCR113		C50A, BTY65
S62/3D		DLS21	SCR114		C50G, BTY66
S75/3D		DLS23	SCR115		C50B, BTY67
S102/3K		9D1387	SCR116		C50H, BTY68
S130	1110	GTR120A	SCR117		C50C, BTY69
S130P	45	GTR120A	SCR118		C50D, BTY70
S213		PM12M, US2, W21	SD	1170	DDA41, V914
S215	3695	S21, 215SG, PM, 12	SD2		PM2HL
S215A	3696	221	SD6	1989	
S215B	1018	221	SD61	1092	EA50, 6D1
S215M	1018	5B1, PM12, S23	SDR		5555
S215VM	1028	PM12M, VS2, W21	SDS		5553B
S218		SP2, Z22	SE5A1		T946H
S410	1159	PM, 14	SE211C		SE211, PM12M, VS2
S420		VP4B	SG215	3702	VS2, 215SG
S434N		VPT4	SG215A		PM12M, VS2, 215SG
S435N		SP4, MS4B, SPT4A	SG220	1018	221
S610	3698		SG250	1031	ESG250
S625	1317		SGA1	1190	AC/SG, S4VA
S629		S620	SIM2	2154	CS12B
S856		0A2, OS, 1207	SIM5	2155	CS12BR
S860		0B2, OS, 1204	SIM95	286	GTR9SM/S, 95A1
S1328		SP13	SM150	287	150A2, 150B3
S2012N		S2010N	SN947D	471	EL70, 5902
SAL39	3876		SN954	473	5641, EY70
SC1/350	2456		SN956B	2241	DY70
SC1/400	2457		SP2	1320	210SPT, SPT2, Z21
SC1/500			SP2D	1322	SP10, Z21
SC1/600	2458		SP4	1324	AC/S2, HP4101C, MSPen, SPT4A
SC1/800	2459		SP4B	3703	MS/PenB
SC1/1000	2460		SP6	136	EF91, 8D3, 6AM6, Z77, 6F12
SC1/1200	2461		SP13	1108	8D2, SP13A
SC1/1400	2462		SP13B	3704	SP13C
SC1/1600	6065		SP13C	3704	8D2, 13SPA, C50B
SC1/1800	6066		SP40Pen	1104	PT15
SC1/2000	6067		SP41	1574	5A/207D
SC2/2500			SP42	1336	
SC2/3000	5844		SP61	1065	
SC2/3500			SP210	1322	SP2, Z21
SC2/4000			SP215	1320	
SCR52		BTY41, C36F	SP220		PM202, P2
SCR53		C36A, BTY42	SP1320		SP13C
SCR54		BTY43, C36G	SPT2	1049	210SPT, Z21, SP2
SCR55		BTY44, C36B	SPT4A	1282	8A1, MS/Pen, AC/SG, MSP4
SCR56		C36H, BTY45	SRS4452	2799	QQE03/20, 6252, QQV03/20A, TT20
SCR57		BTY46, C36C	SS22AF	39	
SCR58		C36D, BTY47	SS210	1018	PM12, 5B1, S23S215
SCR72		C35F, BTY50	SS240SP		SS220SP
SCR73		C35A, BTY51	SS1971	1604	3Q/211E
SCR74		C35G, BTY52	ST11	188	7475, E1436
SCR75		C35B, BTZ20	ST90K		Z900T, 5823
SCR76		C35H, BTY53	STE1000/2.5/15	5027	5559, XG1-2500

TYPE	CV No.	EQUIVALENTS
STE1300/01/5	797	2D21, EN91, 4G/280K
STE2500/6/40		105, STE2500/640, XGQ2-6400
STE15000/15/45		DCG7/100
STR108/30		0B2, QS1204
STR150/30	1832	0A2, QS1207
STV70/20	284	75B1
STV70/60	1895	
STV85/8		22/020
STV85/10	449	85A2, 0G3, QS1209, 5651
STV108/30	1833	0B2, 108C1, G108/1K
STV150/30	1832	0A2, 150C2, QS1207, G150/4K
STV150/200	3709	
STV280/40	1068	G280/1B
STV280/80	1069	G280/2B
STV280/80A	3712	
STV500/0.1		22/030
SU25	1921	U24
SU41	1113	U17
SU44	261	2T/270K
SU45	371	1966
SU61		EY51, 6X2, R12, R12A, U43, U151
SU150	128	
SU750	128	
SU2130	1290	U16, HVR1
SU2150	3751	U21
SU2150A	1290	HVR2A
SU4150A	1134	HVR2
SV-0A2	1832	0A2, 4020
SV-0B2	1833	0B2, 108C1
SV2C39A	2516	2C39A, TD1-100A
SV-2D21	797	2D21, EN91
SV-3B28	1835	3B28
SV-3D21A	2659	3D21A
SV-3D22	2851	3D22
SV-4B32	2518	4B32
SV4X/150A	2519	4X150A
SV-4X150D	3991	4X150D
SV-57	5027	3V390B
SV-75/30	3598	
SV280/40	1068	
SV280/80	1069	
SV-705A	3587	705A, 2T/450E
SV813	26	813, C143
SV-828	631	828
SV-5545	2215	XR1-6400
SV-VR150/30	216	0D3, 150C3
SW5	3715	
SW7	3719	CV1069
SW10H	1076	DA91, TZ40
SW35Pen	1370	PY1/35
SW75Pen	1371	PZ1-75
SX541	2384	ZS10C
SX542	2413	ZS20
SX643	4077	ZS21
SX644	4078	ZS22
SYM4193A		7008
SZ53		K351
T2G9/10E	357	D165747
T2M05		6J6

TYPE	CV No.	EQUIVALENTS
T4A/9AA		4001AM
T4A/15AB		4001F
T4A/15AD		4001N
T4A/15DA		4005N
T4A/75AA		4001C
T4D	3721	D1
T6D		EA50
T20	3722	V970
T20G	1047	3B/200B
T21	3679	RK49
T21-105	858	6J6, ECC91
T31		
T40		T50-1
T41	3723	
T54P1		DG13-58
T54P2		DN13-58
T54P11		DB13-58
T54P31		5BHP31, DH13-78
T55		T50-1
T130-1	1924	5866, TY2-125
T200	3724	H4D, 11A2
T250	1030	ET30
T300/1		TB3/1000
T350-1		5867, TY4-400
T813	26	813, QY2-100
T814	2658	806
T901		MW41-1
T901A		MW41-1
T924Z	429	MF31-55
T938Y	5300	AL22-10, 9RP33
T2000	1121	
TA10		
TA15		
TB2.5/300	1924	5866, TY2-125
TB2.5/400		RS614
TB3/750	3479	5867, T3501-1, RS630, TY4-400
TB4/1250	1351	5868, RS631, TY4-500
TB4/1500		B1152
TB5/2500		7092, TY6-800, B1153
TBL2/300		7004, TD2-300A
TBL2-400		TD2-400A
TBL2-500		TD2-500A
TBL6-14		7804, TY8-15A
TBL6-20		TY6-12A
TBL6-4000		TY6-1250A
TBL6/6000	3926	5924, TY6-5000A
TBL7/8000		6961, TY7-6000A
TBL7-9000		8269, TY8-6000A
TBL12-25		6618, TY12-25A
TBL12-38		7806, TY12-20A
TBL12-40		TY12-15A
TBL12/100		6078, TY12-50A
TBL12/250		6618
TBW6-14		7805, TY8-15W
TBW6-20		TY6-12W
TBW6/600		5923, TY6-5000W
TBW7/800		6960, TY7-6000W
TBW7-9000		8268, TY8-6000W
TBW12/25		6617, TY12-25W
TBW12-38		7087, TY12-20W

TYPE	CV No.	EQUIVALENTS
TBW12/100		6077, TY12-50W
TD03-5	345	DET23
TD03-8	3988	6442
TD03-10	273	DET22
TD03-10D	5962	
TD03-10E	5458	
TD03-10F	2204	A2327
TD03-10G		5861
TD04-20	397	DET24
TD04-20A	5754	CV5747, Q/DET24
TD05-12	2933	2C46
TD1-100A	2516	2C39A
TD2-300A		7004
TD2.5-12	688	464A
TD3-12	2932	2C42
TD4-10	2201	E2043
TD6		EA50, 2B35, 6D1
TD17	474	5643, EN70
TD24	2798	6360, QQV03-10
TD25	2797	5894, QQV06-40A
TDD2	1044	HL21DD, HD24
TDD2A	3726	HD24, H2D, 210DDT
TDD4	3727	DDT4, 11D3, AC/HLDD, DDT
TDD13C	1419	DDT13, 11D3, HL/DD/1320
TG30		3C45
TG57		PL5557
TG200	1787	6268, 4C35, XH8-100
TG1000	2520	5C22, 6279, XH16-200
TG3000		5949
TGRB		872A, 2V/471A
TH2	1410	X24, 220TH
TH4	1460	20A1, AC/TH1, X41
TH4A	1194	20A1, AC/TH1
TH4B	1194	ACTH1, X41
TH21C		TH2321, TH29
TH22C		TH29, TH2320
TH30C		TH2321, 302THA
TH41	1411	
TH225		2K25
TH813	26	QB2-250, QY2-100, 5C/100A
TH1249		2J49
TH1250		2J50
TH1450		4J50
TH1452		4J52
TH1478		4J78
TH1526		5J26
TH1725A		725
TH2200		K345
TH2312		TH29
TH2320		TH2321
TH5021B	32	DCG4/1000G, GU12, 866A
TH5021V	1625	DCG4/1000ED, RG3-250
TH5031	1449	872A
TH5031B	1835	DCG5/5000GB, 3B28, 872A, TGRB, 2V/471A
TH5040		869B
TH5221		3B28
TH5221B	1835	3B28, RR3-250, GXU1
TH5221V/B		DCX/1000, 3B28, 2G/402A
TFI6011		PL5577

TYPE	CV No.	EQUIVALENTS
TH6031		PL5559
TH6120		PL105
TH6220		PL5545
TH6220A		6807, XR1-6400A
TH6230		PL3C23
TH6250	5957	5855, XR1-12
TH6345		3C45
TH6435	1787	6268, 4C35, XH8-100
TH6522	2520	5C22, HT415, XH16-200, 6279
TH6907	3521	5949, 1907, XH25-500
TH7020		5551A, BK42C
TH7030		5552A, BK24C
TH7040		5553B
TH9700		7293/E
TH9804		7038
TMC15B	3730	
TMC16B	3731	
TMC20B	3732	405UA
TP4	1718	AC/TP
TP22	1344	
TP25	1345	
TP26	3735	
TQ1/2		3C23, ASG5023
TQ2		PL17, TH6011, FG17, ASG5017
TQ2-3	2210	5544, ASG5044A, XR1-3200
TQ2/6	2215	5545, C6J, TH6020, XR1-6400
TRC1	713	
TRC2	115	
TRN1	2285	
TRN2	2157	
TRP2	6060	
TRP3	2430	
TRP4	2378	
TRP5	2379	
TRP6	2429	
TRP8	2488	
TRP10	5398	
TRP11	5210	
TRP12	5315	
TRP13	5381	
TRP14	6129	
TRPS	2379	
TRW1	2351	
TRW2	2303	
TRW5	2297	
TRW7	3539	6024, ATR387
TS49		C3M
TS51	850	6AK5, EF95
TS52	858	6J6, ECC91
TS54		6689, E83F
TS70	798	2E22
TSP4	560	AC/SP3, RTSP4
TSW05	1288	DET12
TSW50	1288	DET12, 4304CB, 3B/504B
TSW50A	1235	
TSY4-500	1889	
TT4	1179	41FP, ML4, AC/P
TT10	26	813, QY2-100, 5C/100A, TH813
TT11	1501	E1192
TT12	524	



TYPE	CV No.	EQUIVALENTS
TT15	415	44A/160M
TT16	2963	C1108, 4-125A, QY3-125B
TT16D		C1108
TT17	2957	PL5557, XG5-500
TT18	2666	829B, C144, QQV07-40
TT20	2799	QQV03-20A, C1134, 6252, 55B/200A
TT21		7623
TT22		7624
TT23	2466	QQV02-6, 6939
TT24	2798	QQV03-10, 6360
TT25	2797	QQV06-40A, 5894
TT100		
TT101		
TTR21MR	3841	6F1
TTR31	221	E1516
TTR31MC	1748	
TTR31MR	1923	
TV03-10	1573	
TV03-10A	1089	
TV4	1412	TV4A
TV4A	1412	TV4
TV6	2942	RM1, ME6S
TV101		ESU151
TV102	1504	VU504
TV801		4303CB, TY1-50
TWC5	5348	
TWS1		W13/1D
TWS2	5363	
TWS6	6085	
TWS7	6117	
TX2/3	2210	5544, XR1-3200
TX2/6	2215	5545, XR1-6400, 3G/502A, 6807
TX3-200	2739	
TX4	1194	X41, 20A1, AC/TH1
TX5-400	3740	
TX12-12W	2871	CAT6
TX41		TH4B
TX920	5027	5559, XG1-2500
TXM100		2D21, EN91
TY1-50	1288	DET12, 8019
TY2-125	1924	5866
TY3-250	1350	5867, RS630, TY4-400
TY4-350	635	833A, 3C/A02E
TY4-350	536	4120/AA
TY4-500	135	5863, RS631
TY5-500		TB4/1500, B1152, 14D12
TY6-800		TB5/2500, 7092, B1153
TY6-1250A		7753, TY6-1250A
TY6-5000A	3926	5924
TY6-5000B	8730	BR1160, YD1120, 5762
TY6-5000W		5923, TBW6/6000
TY7-6000A	5239	TBL7/8000, 6961
TY7-6000W		TBW7/8000, 8268, 6960
TY8-15A		7804
TY8-15W		7805
TY8-6000A		8269
TY8-6000W		8268
TY12-20A		7806
TY12-20W		7806
TY12-20W		7807

TYPE	CV No.	EQUIVALENTS
TY12-25		TBW12/25
TY12-25A		TBW12/25, 6618
TY12-25W		6617
TY12-50A		6078, TBL12/100
TY12-50W		6077, TBW12/100
TYS4-500	1889	
TZ03-20	1047	3B/200B
TZ2-250	1618	ES250M
TZ2-300	3741	
TZ4C		DA41
TZ20	3742	
TZ40	1076	DA41, SW40W
U4	1608	
U5	3743	
U6	3744	
U10	1443	RV120/350, R1, UU5, 506BU
U12	1064	DW4-500, UU120/350
U14	1796	DW4-500, R3, 1561, UU5
U15	3747	R4A, 1561
U16	1290	SU2150A, HVR1
U17	1113	
U18	1264	FW4/500, 451U
U18/20	31	FW4/800, AZ50
U19	187	
U19/23	187	
U20	31	FW4/800
U21	3751	FW4/800
U22	3750	
U23	235	
U24	1921	B142
U25		2L2, U47
U26	2966	2J2, EY86, U49, 6S2
U27	1111	V1907, 19G12, 2T/360B
U30	3752	
U31	3753	25Z4G, PY31
U33		VLS61
U37	2289	1T2, R13
U41	2115	1T2, 1B3GT, DY30
U43	426	EY51, R12A, 6X2, U151, SU61
U45		U25
U47		U26, U25
U49		2J2, R20, U26
U50	1268	5Y3GT, 5Z4
U52	1071	5U4G, GZ31, 5931
U54	378	53KU, GZ37
U60	4075	
U70	574	6X5GT, EZ35, U147
U74		35Z4GT, U76
U76		U74, 35Z4GT
U78	493	6X4, EZ90
U82	3919	Z724, 7Z4, U149
U118		U145, U404
U119		UY85, 38A3, U189, U381
U142		UY41, 31A3, 311SU
U143	2862	AZ31
U145		U404, UY41
U147	574	6X5, EZ35, U70, 5852
U149		7Y4, U82
U150	3891	EZ40, 6BT4, UU9, 66KU
U151	426	EY51, 6X2, R12, SU61, U43

TYPE	CV No.	EQUIVALENTS	TYPE	CV No.	EQUIVALENTS
U152		PY80, 19X3, EZ40	UM85		10M2
U153		PY81, 17Z3	UN312E		4212E, 3C/270A
U154		PY82, 19Y3, U192, U319, 19SU	UP		U10
U192		PY82, 19Y3, U154, U319, 19SU	UR1		CY1
U201		CY31, U281, U301	UR1C	1267	V20, 1D5, CY1C, U4020
U281		CY31, U201, U301	UR2		PV29S, UR3
U291		PY32	UR3		CY3
U301		CY31, U281, U201	UR3C	3758	
U309		PY80, 19X3	UR40/F	4121	
U319		U309, PY82, 19Y3, U154, U192, 19SU, U153	UR45	4116	
U329		PY81, U251	UR/75/30		
U339		U191	UR/105/30		
U349			UR/150/30		
U381		UY85, U119, 38A3	UU2		R2, R41
U404		31A3, UY41	UU3		IW4-350, R2, R3, R1, MU14, R42, 1867
U600	3756		UU4	3759	IW4-350, R3, MUM, R42, 1867
U709	5072	EZ81, 6CA4, UU12	UU5	1039	IW4-500, R3MU14
U718	3891	UU9, 6BT4, EZ40	UU6	1413	
U4020	1267	V30, UR1C, 40SUA, 1D5	UU7	3761	UU8
UAA91		12AL5	UU9	1855	EZ40U150, 6BT4, 66KU
UABC80		DH109, 10LD12	UU10		RV200/600
UAF42		UAF41, 12S7, WD142	UU12	5072	EZ81, 6CA4, U709
UBC41		14L7, 10LD3, DH142, 141DDT	UU60/250		IW4-350, R2, R42, 1867, UU5, UU3
UBC81		10LD13	UU120/250		IW4-350, R2, UU5
UBF80		171, DDP, 17C8	UU120/350	1796	RV120/350, R2, DW4/350
UBF89		10FD12, WD119, 19FL8	UU120/500	1064	APV4, R3, IW4-500, MUM, R3, R43
UC92		9AB4	UV203A	2986	203A
UCC85		B109, 10L14	UX866		DCG4/1000GB
UCH41		CF141	UX6653	3592	
UCH42		UCH43, 14K7, X142, 141TH	UY1(N)		UY1
UCH71		UCH21	UY21		UY1N
UCH81		X119, 10C14, 19D8	UY41		UY42, 31A3, U142, 311SU, U404
UCH171		UCH81, 19D8	UY82		55N3
UCL82		50BM8, LN119, 10PL12	UY85		U381, 38A3, U119
UD2		PM202	UY807		807
UD41			V2M70	493	6X4, EZ90, U78
UD143	2293	XB1	V20	764	UR1C, CY1C
UD166C	2257	XC11	V20S		CY1, UR1
UE301	621	801	V30	7011	1D5, U4020
UE311	25	4242A, ES85	V40	2967	8020, RY12-100
UE905	625	805, RK57	V41	3892	AZ41
UE938	638	838, RK58	V54		K358
UE945	735	845	V61	3891	EZ40, UU9, 6BT4, U150
UE966	32	DCG/1000G, 866A, GU12	V70D		T50-1
UE966A		DCG4/1000G, 866A, GU12A	V120	3762	
UE967	2957	5557, XG5-500	V123	3763	
UE972	642	872A	V154		K353
UE972A		DCG5/5000GB	V203A/1K	234	
UE1967		PL5557	V203C/LD	230	
UF41		12AC5, W142, 121VP	V226	3765	
UF42		Z142	V230A/K	299	
UF85		19BY7	V233A/1K	2190	
UF89		12DA6	V235A/1K	2221	
UHP52		UHP51	V239/1K	5048	
UL41	1977	45A5, N142, 451PT	V239C/1K		5048
UL46	1977	N142, 45A5	V240C/2K	2189	
UL84		10D18, 45B5, N119, 10P18	V241C/1K	5049	
UM34		10M1	V245	1367	
UM80		Y119, 19BR5	V246A/1K	228	
			V248A	1366	

TYPE	CV No.	EQUIVALENTS
V257	1723	
V271C/34	5911	
V312	3766	41MTL
V339	3767	
V503	3768	DA30, 440XP, 3B/355B
V625	93	
V630	201	
V741	133	EC90
V872	1116	6F32
V877	3769	
V884	131	6CQ6, EF92, 9D6, W77
V885	132	
V886	136	6AM5, EL91, N77
V887	136	EL91, N77
V914	1170	2D4A, DDL4, D41
V944A	3797	
V995	3770	
V960	54	
V970	3772	
V1010	3773	
V1020	3774	
V1021	3775	
V1023	3776	
V1029	3777	
V1040	987	
V1042	275	
V1043	401	
V1047	961	
V1052	441	
V1063P1	400	
V1101	1361	MX05-20
V1105	3778	
V1111	1127	Pen46
V1120	72	
V1120B	73	11E3
V1133	276	11E2
V1135B	345	12E1
V1135C	377	1963
V1501	3581	3C/495A
V1505	1252	212E, MY3-275
V1507A	1504	EHT1
V1901	1504	EHT1, 2S/490C
V1904	1072	MU4250
V1906	20	
V1907	1111	R11, U1906
V1913	1508	U19
V1920	121	19H1
V1922	74	ESU74
V1924	100	
V1928	261	2T/270K, R10
V1939	371	19G6
V2024	125	
V2030F	349	
V2046A	486	
V2053	403	
VA16	528	
VA35	285	
VA50	2132	90AV, CAV29
VA201B	2494	K351
VA203B		K59-30

TYPE	CV No.	EQUIVALENTS
VA220		K345
VA220A		KS7-1000A
VA220B		KS7-1000B
VA220C		KS7-1000C
VA220D		KS6-1000D
VA220E		KS6-1000E
VA220F		KS6-1000F
VA220G		KS6-1000G
VA200Z		KS7-1000Z
VF01	80	
VF08	81	
VFT6	2747	6U5G6M1, Y61
VG1	2976	NE2, GET2
VG410		VG406
VG2503		
VG3008		
VH550		DCG4/1000ED
VH550A	32	DCG4/1000G, CU12
VH7400		DCG4/5000GB
VH7400A		DCG4/5000EG
VHT2		FC2X22
VHT2A	1043	FC2A, 210PGX22
VHT4	2955	FC415A2, MX4041MVG
VHT	2956	15D1, FC13C
VHTS		X30
VJ5552		PL552A5
VLS61		U33
VLS452	3784	5A/102A
VLS492AG	1527	C655/1G
VLS631		S102/1, KZ530333
VM4V		AS4125
VME4		AC/ME
VMP4	1169	9A1VPT4
VMS48	1677	AC/SGMM4V
VMP4G	1169	9A1, MVSPen, VMP49
VMP4Met	1169	9A1
VMS4	1165	AS4125
V02		FC2A, X22
V04	2955	FC4, MX40, VHT4
V06S	1426	EK2
V013		FC13C, 15D1, TH2320
V013S		FC13
VP2	3787	VP21, W21, 210VPT
VP213	520	VP21, VP210
VP2D	1083	VP210, VP2, VP21
VP4		VP4A
VP4C	518	AC/VP1, VP4
VP4Met	3788	9A1
VP4A	1169	9A1, AC/VP1, MVS/Pen
VP4B	3582	AC/VP2, MVS/Pen, 13W42
VP6	131	EF92, 9D6, 6CQ6, W77, 6F21
VP12D	531	12C8
VP13		VP1320
VP13B	3796	VP1322, VP13C
VP13C	3790	9D2, VP1322, 13VPA
VP13K	1106	9D2
VP21	1083	VP210
VP23	3792	VP22
VP24Met	3793	
VP41	21	VP4B, AC/VP2

TYPE	CV No.	EQUIVALENTS
VP133	1457	
VP210	3794	VP2W21, 210VPT
VP1322	3796	VP13B, 9D2, 13VPA
VPT2		VP210, 210VPT, W21
VPT4	1169	9A1, VP21, MVS/Pen, AC/VP1
VPT4B	1169	9A1, AC/WP1
VPT210	1083	VP2
VPTS		W30
VR75/30	3798	OA3, G75/2D, QS75/40
VR90-30	3799	OB3
VR90-ST		OB3
VR92	375	CV1092, EA50
VR105-30	686	OC3, G105/1D, QS1206, 4678K
VR105-MT		OB2
VR105-ST		OC3
VR150-30	216	OD3, QS150/40, 150C3, G150/30
VR150-MT		OA2
VR150-ST		OD3
VS2	3800	PM12M, W21
VS10G	5290	
VS10H	6103	
VS18BO	3625	PE8
VS24	3802	PM12M, VS2
VS24/K.Met	3803	PM12M, VS2
VS26	161	
VS50	2134	90CV, CMV29
VS70	188	CV1070, 7475, QS92/10
VS210		PM12M, VS2, W21
VS215		PM12M, VS2, W21
VASG1	1677	AC/SG
VX2		VP2B
VX550A		DCX4/1000
VX7400		DCX4/5000
W5/1G		6W50
W7/1D	2358	
W7/2D	2188	
W7/3G	5293	
W13/1D		TWS1
W17	785	DF91, 1T4, 1F3
W21		VP210, 210VPA
W21-4	171	210VPT
W21-7	3804	VP21
W25		DF96, 1AJ4, 1F1
W30K	3805	
W31	3806	
W42	2832	AC/VP2, VP4B
W61	100	V1924, 6K7
W61M		
W63	1183	6K7G, 6UT, KTW63
W76		12K7, KTW, 74M
W77	131	EF92, 9D6, 6F21, VP6, 6CQ
W81		7H7, W143
W118		W145, 10F9
W119		10F18
W142		UF41, 12AC5
W143		EF22, 7H7, W148, W81
W145		10F9
W147	1053	EF39
W148		7H7, W143, W81
W149		7B7

TYPE	CV No.	EQUIVALENTS
W150	3886	EF41, 6CJ5, 62VP
W719	1375	EF85, 6BY7, 6F19, 6F26
W727	454	EF93, 6BA6, PM04
W719		6F20
W731D	2538	59
W739		6F18, 10FD12, 19FL8
WD30	3810	
WD119		UBF89, 19FL8
WD142		UAF42, 12S7
WD150	3883	EAF42, 6CT7
WD709		EBF80, 6N8, ZD152
WE12		EM4
WE17		5551
WE189		1163
WL17		5551
WL631		5559, 3V/390A, BK66D, 57
WL651		5552A
WL652		5551A, BK42C
WL653B		5555, BK46
WL655		5553B, BK146C
WL-813	26	813, 5C/100A
WL-833	635	ES833, 3C/402E
WL-869B		ESU111, 2V/540
WL-872A	1449	872A, 2V/471A
WL2899416D		1163, VE289
WRNI8131	3873	3Q/81OE
WT210-0001	797	2D21, 4G/280K
WT210-0003		WL884
WT210-0004		WL2050, 20A2, 4G/281D
WT210-0008		866A, GU12, 2V/4000A
WT210-0011		0C3
WT210-0016		0B3
WT210-0027		872A, CV471A
WT210-0038		WL172
WT210-0043		5796
WT210-0044		575A, ESU575, 2V/510A
WT210-0045		892, ESW8923Q/197E
WT210-0047		3C23
WT210-0051		0A2
WT210-0054		5830
WT210-0056		PL5559, 57, 3V/390A
WT210-0057		632B
WT210-0058		KU676
WT210-0059		677
WT210-0063		5685
WT210-0066		5665
WT210-0069		5557
WT210-0070		5550
WT210-0071		5551A
WT210-0072		5552A
WT210-0073		5553B
WT210-0074		WL105
WT210-0075		5822
WT210-0077		5727
WT210-0078		WL182
WT210-0079		105
WT210-0086		833A, ES833, 3C/402E
WT210-0091		0A4G
WT210-0093		5668
WT210-0100		5796

TYPE	CV No.	EQUIVALENTS
WT210-0141		5796
WT210-0157		5552A
WT246		20A2, WG/281D
WT262		2V/400A, 866A, GU12
WT269		VR105/30, G105/1D
WT272		PL5557, TQ2
WT294	686	VR150/30, G150/3D
WT382		872A, 2V/471A
WT606	797	2D21, 4G/280K
WT-T104		ESU575, 2V/510A
WT-T105		892, ESW892, 3Q/197E
WT-T106		6011
WT-T108		3C23
WT-T110		5830
WT-T111		5559, 57, 3V/390A
WT-T112		632B
WT-T113		KU676
WT-T117		5557
WT-T118		105
WT-T119		172
WT-T127		833A, ES833, 3C/402E
WT/T132		0A4G
WT-T141	3798	VR57, VR75/30, G75/2D
X14		1A7, DK32
X17	782	DK91, 1R5, 1C1
X18		DK92, 1AC6
X20		DK92, 1AC6, X18, 1C2
X21	3816	FC2A, VHT2A
X21Met	3817	
X22	3818	FC2, 210PG
X23	1082	220TH, TH2
X24	3819	220TH, TH2
X24Met	3820	220TH
X25		DK96, 1AB6, 1C3
X30		1501
X31	3821	2002
X31Met	3822	
X41	1460	20A1, ACTH1, 415TH, TH4
X41Met	3823	
X42	3576	MH4105, 15A2, 41MPG, MX40
X61M	281	ECH35, 6K8, X65
X63	3825	6A8G
X64	1208	6L7G
X65	3826	6K8G, X147
X66	1099	AF3
X71		12K8, X76M
X76		12K8, X71M
X77	132	EK90, 6BE6, X727
X79	5115	6AE8
X81		7S7, X148
X117		5D22
X118		X145, 10C1
X119		UCH81, 10C14, 19D8
X142		UCH42, 14K7, 141TH
X143		ECH21
X145		X165, X118, 10C1
X147	1581	ECH35, 6K8G, X61M
X148		7S7, X81
X150	3888	ECH42, 6CU7, 6C10, 62TH
X661	2183	
X662	2234	
X719	2128	ECH81, 6AJ8, 6C12
X727	453	EK90, 6BE6, X77, X727

TYPE	CV No.	EQUIVALENTS
X1100		N1029
X961101	988	G
X961102		LN1
X962106	982	BT
XAA91		3AL5
XB1	2293	UD143
XB875B		2051
XB7674	1848	20A2
XC12		
XC12T		
XC15		
XC15T		
XC18		
XC23		
XC30T		
XC31		
XCC82		7AU7
XE1	495	5802
XE2	2202	
XF85		3BY7
XF184		3EJ7
XFR1	2237	1A04, DF62
XFR2	2254	5678, DF60
XFR5	2275	6375, DC70
XFN40	2260	DF64
XFY14	2238	5672, DL620
XG1-2500	5027	5559, BT5
XG2	474	5643, EN70
XG2-12		255
XG2-500	1144	BT19
XG2-6400		3V/490A
XG5-500	2957	FG17, 5557, TT17
XG15/10		DCG7/100
XG15/12		DCG7/100B, BT69
XG25		PL260
XGQ2-6400		PL105
XGR3	151	
XH1.5	3830	
XH3-045	372	BT79, 3C45, FX227
XH8-100	1787	6268, 4C35
XH16-200	2520	6279, 5C22
XH25-500	3521	5949, 1907, FX229
XL02.0V	1701	
XL1.5V	1720	
XL2V	3831	
XN	14	
XN3		GN6
XP1.5V	176	
XP2.0V	1702	
XP4	1168	PX4
XR1-12	5957	5855
XR1-1600	3706	5796
XR1-1600A		21B12, 3G/450
XR1-3200	2210	5544
XR1-6400	2215	5545, 3G/501A
XR1-6400A		6807, 3G/502A
XR6	465	EF72
XR7	466	EF73, 6488
XR8	468	6K4, EC70, 6778
XR81		KS35-50
XSG1.5V	175	
XSG2.0V	3833	

TYPE	CV No.	EQUIVALENTS
XW2.0V	1703	
XXB		3C6
XXD		14AF7
XXFM		7X7
Y25	2980	1M1, DM70
Y61	1103	6U5G, 6M1
Y62	2747	6G5G, 6M1, Y64
Y63	1103	6U5G, 6M1, 63ME, 6H45
Y64	2747	6G5G, 6M1
Y65	51	A1320
Y119		UM80, 19BR5
Y220	1118	PT2, KT2
YD1010		TY12-120W
YD1110		8415
YF183		4EH7
YF184		4EJ7
YJ1000		JP9-2.5B
YJ1060		6027H
YJ1070	6108	
YK1090		K353
YK1091		K358
YL1020		8118, QQ203-20
YL1030		8408, QQ206-40
YL1060		7854
YL1070		8117
YL1071		
YL1100		6884
YL1101		6816
YL1110		7650
YL1120		8429
YL1130		8408
Z14		1N5G, DF33
Z21	3836	215SG, SPJ2
Z22		SPT2-210SPT
Z62	3838	12CS7GT, KTZ63
Z63		6J7G, KTZ63
Z66	3839	6BM6
Z70U		Z700U
Z70W		Z700W
Z71U		Z701U
Z77	138	EF91, 8D3, 6AM6, SP6, 6F12
Z90	1091	EF50
Z142		UF42, 10F3
Z145		10F1
Z150	3887	EF42
Z152	1376	EF80, 6BX6, 6BW7, Z719, 64SPT
Z179		
Z203C	2271	GC10B
Z211/1G		K329
Z225		DQ2
Z239/1G	2187	
Z300T	1992	1267
Z303C	2271	QC10B, 6482
Z319	2276	
Z319/1G	2187	
Z327/1KW	5437	
Z329		30F5
Z502S	2325	GC10C/S
Z503M	5291	

TYPE	CV No.	EQUIVALENTS
Z504S		8433, ZM1070
Z505S		ZM1060
Z510M	5278	6844
Z520M		GN-4
Z521M		GS-4
Z700U	5820	7710, CCT6
Z700W		7709
Z701U		7711
Z719	1376	6BX6, EF80, 6BW7, Z152, 64SPT
Z729	2901	EF86, 6F22, 6267
Z759	5060	
Z800U	2236	
Z801U	2255	
Z803U	2434	6779
Z804U		7713
Z900T	5122	5823
Z5823		2900T
Z530331		DLS10, S60/1B
Z530332	979	DLS10
Z530333		VLS631, S102/1K
Z530352	979	DLS10
ZA1	1175	A41, AP
ZA2	1095	4672, 954
ZAA		5B/104Q
ZD	2889	DD620
ZD17	784	DAF96, 1AH5, 1FD1
ZD25		6N8, EBF80, WD709
ZD152		6N8, EBF80, WD709
ZG532	2647	532
ZG547	372	BT19
ZP455	2789	9LP7
ZP477	914	12DP7
ZP527	855	6C21
ZP572		2C39A, 3H/151J
ZP579	3842	5J29
ZP584	3843	5J30
ZP590	3844	5J31
ZT1000		8270
ZT1011	5234	8063, ZT1011, ZR1-1600A
ZZ1020		STV85/8

## BRITISH SERVICE TYPES TO COMMERCIAL TYPES

SERVICE TYPE	COMMERCIAL EQUIVALENT	SERVICE TYPE	COMMERCIAL EQUIVALENT	SERVICE TYPE	COMMERCIAL EQUIVALENT
AD1	DLS10	ATS25A	807	CV69	E1326
AR4	PM1HF	ATS70	4282B	CV71	ASGL1M
AR5	P220	AU1	U18	CV72	V1120
AR6	LP2	AU2	RG250	CV73	11E3
AR7	4D1	AU3	U12/14	CV74	ESU74
AR8	HL23DD	AU3A	1561	CV75	4313C
AR9	PM1LF	AU4	U17	CV76	E1359
AR10	TDD2A	AU5	V1907	CV77	KTUBE
AR11	4019B	AU6	GU50	CV78	E1474
AR12	4020A	AU8	U22	CV79	E1429
AR13	B406	AU12	U15	CV80	VF01
AR14	220RC	AU13	5Z4	CV81	VF08
AR15	220LF	AW2	7475	CV82	3A/147J
AR16	220B	AW3	S130	CV84	4033A
AR17	MH4	AW4	STV280/40	CV85	V2023
AR21	EBC33	AW6	EM31	CV87	KRN2
ARD2	D1	CV1	D051	CV88	3A/148J
ARD4	D42	CV2	E1228	CV89	E1430
ARDD1	10D1	CV3	AFN202	CV90	E1368
ARDD3	6H6	CV4	E1229	CV92	4C27
ARDD5	EB34	CV5	4049D	CV93	V625
ARH1	6L7	CV6	DET20	CV94	DS103
ARP1	PT2	CV7	E1209	CV95	R3/10
ARP2	SP2	CV8	E1248	CV96	R3/16
ARP3	9D2	CV9	AL60	CV97	R2/10
ARP4	SP210	CV12	E1191	CV98	R2/38
ARP5	VP2	CV13	BT9B	CV99	E1373
ARP6	SP4	CV14	XN	CV100	V1924
ARP7	42MPT	CV15	E1266	CV105	E1371
ARP8	AC4Pen	CV16	3J/145J	CV108	BM313
ARP9	Pen1340	CV18	DET19	CV109	9KP5
ARP9A	7D8	CV19	EHT1	CV110	VS68
ARP10	PenA4	CV20	V1906	CV114	E1265
ARP11	TSP4	CV21	VP41	CV115	E1415
ARP12	VP23	CV22	BT45	CV116	KR6/1
ARP13	VP210	CV23	E1278	CV117	E1417
ARP14	2201PT	CV24	HL41	CV118	SP61
ARP15	KTW63	CV25	4242A	CV119	XJ
ARP16	6J7	CV26	813	CV120	MF
ARP17	6F6	CV27	4357A	CV121	V1920
ARP18	KT24	CV28	ACT9	CV122	E1336
ARP19	SP41	CV29	E1235	CV123	E1330
ARP21	Z62	CV30	4270A	CV124	807
ARP22	116/Pen	CV31	U20	CV125	V2024
ARP23	MS/Pen	CV32	RG3-250A	CV126	E1362
ARP24	220VPT	CV33	4077A	CV127	3B/401J
ARP25	KT41	CV34	MR10	CV128	SU750
ARP26	KT44	CV38	E1198	CV129	KRN2A
ARP33	MSP4	CV39	S22AF	CV130	KRN3
ARP34	EF39	CV40	E1255	CV131	9D6
ARP35	EF50	CV41	E1267	CV132	V885
ARP36	SP61	CV42	E1256	CV133	6C4
ARP37	QP25	CV44	E1155	CV135	EY91
ARP38	KTZ73	CV45	S130P	CV136	EL91
ARS7	VS24	CV46	8011	CV137	EAC91
ARS8	PM12V	CV49	3B/501A	CV138	EF91
ARTH2	ECH35	CV51	Y65	CV139	6L34
ARTP1	TP22	CV52	E1231	CV140	6AL5
ARTP2	TP25	CV53	3A/146J	CV141	U4B
AT20	MZ05/20	CV54	V960	CV142	XP1.5
AT35	DET25	CV55	E1190	CV143	U3
AT37	ACT36	CV56	E1325	CV144	U4
ATS25	807	CV57	E1271	CV145	U5
ATP4	V248A	CV58	E1273	CV147	U7
ATP5	V245	CV62	E1046	CV148	U8
ATP7	V266	CV63	E1323	CV149	U7
ATP10	1062A	CV64	E1342	CV150	PK150
ATP35	PV1-35	CV65	Pen25	CV152	GU21
ATP75	PT6	CV66	RL37	CV153	E1411
ATP100	4069A	CV68	E1198	CV154	E1419

SERVICE TYPE	COMMERCIAL EQUIVALENT	SERVICE TYPE	COMMERCIAL EQUIVALENT	SERVICE TYPE	COMMERCIAL EQUIVALENT
CV155	E1190	CV250	CMG25RS	CV337	27M1
CV158	KR3	CV251	MX57	CV338	E1524
CV159	AL1	CV252	ACR22	CV339	24B2
CV160	M528	CV253	CS3A	CV342	DLS19
CV161	V526	CV254	30D5	CV343	V894
CV162	5Z094	CV255	VCR516	CV344	E1323
CV163	5744WA	CV256	GTK95M/S	CV345	12E1
CV164	CG3E	CV257	ACT22	CV346	EZ22
CV165	CS36A	CV258	E1273	CV347	EBC21
CV166	GEX54/3	CV259	E1495	CV348	VX4012
CV167	TY4/500B	CV260	SP61	CV349	V2030E
CV168	XD60	CV261	R10	CV352	EBC33
CV169	XD61	CV262	9MD6	CV353	M500
CV170	12SF7GT	CV263	VX3026	CV354	DET23
CV171	210VPT	CV264	AP1188	CV355	E1511
CV172	E1468	CV265	19E2	CV356	E1511
CV173	EF55	CV266	E1336	CV357	D165747
CV174	E1459	CV267	E1336	CV358	EF37A
CV175	XSG1.5	CV268	E1330	CV359	NE17
CV176	XP1.5	CV269	VCR97	CV360	NE18
CV177	M125H	CV270	VX3027	CV361	5B/700A
CV178	E1458	CV271	V986	CV363	VX363
CV180	KR4	CV272	KR6/4	CV366	6AG7
CV181	ECC32	CV273	5861	CV367	1N21B
CV182	E1488	CV275	V1042	CV368	9-3
CV185	PM202	CV276	11E2	CV369	1B35
CV186	E1342	CV277	19G3	CV370	JP9-7A
CV187	U19	CV278	B65	CV371	19G6
CV188	7475	CV279	NG16	CV372	3C45
CV189	BS4	CV281	X61	CV373	VX380
CV190	DLS10	CV282	E4504/M/16	CV374	S3A
CV191	E1494	CV283	6AL5	CV375	EA50
CV192	E1481	CV284	STV70/20	CV377	V1135C
CV199	NT99	CV285	VA35	CV378	53KU
CV200	MZ2-200	CV286	QS95/10	CV379	ACT19
CV201	V630	CV287	150A2	CV380	EF54
CV202	YF	CV288	ACT23	CV381	VX4024
CV207	AC/P4	CV289	G400	CV382	T24/40JA
CV208	1487	CV290	E1527	CV383	T24/40JB
CV209	MX57	CV292	E1481	CV384	DET5
CV211	V2030B	CV293	CV497	CV385	DL71
CV212	G210/1C	CV295	BS54	CV386	DF70
CV214	E1531	CV296	DDR2	CV387	DL72
CV215	E1497	CV298	FA15	CV388	VX4055
CV216	VR150/30	CV299	V230A/1K	CV389	401CAHA
CV217	KRN3	CV300	VCRX156	CV390	VCRX244
CV218	KRN3	CV301	VX301	CV391	5B/252M
CV219	E1046	CV302	ECH22	CV392	VCRX241
CV220	631/P1	CV303	EF22	CV393	VX7026
CV221	E1516	CV304	EL22	CV394	EM34
CV222	E1489	CV305	EF51	CV395	QS150/45
CV223	KRN2A	CV306	MX52	CV396	VCRX245
CV224	KRN2A	CV307	6LY1	CV397	DET24
CV225	ACT17	CV309	QV04-7	CV398	715B
CV228	V246A/1K	CV310	NHP1	CV399	MH4
CV229	1336	CV311	5L/444	CV400	V1063
CV230	V230C/1D	CV312	ESU74	CV401	V1043
CV232	MF	CV313	QSY50-P40	CV402	BS68
CV233	BS5	CV315	TY1-51	CV403	V2053
CV234	V230A/1K	CV319	E1453	CV404	FVD7
CV235	U23	CV320	E4103/B/4	CV405	927
CV236	E1465	CV321	KT66	CV406	E1423
CV237	KR6/2	CV323	KRN2	CV407	VCRX221
CV238	KR6/3	CV324	CV1628	CV408	A1714
CV240	ACT24	CV326	15B	CV409	A1820
CV242	CMG25	CV327	EF52	CV410	K3A
CV243	4045A	CV328	L9	CV411	GM5
CV244	4046A	CV329	6F33	CV412	A800
CV245	4328D	CV330	EC53	CV413	G150/2D
CV248	GS16	CV335	VCR522B	CV414	VX2040
CV249	3A/107A	CV336	VCR522C	CV415	TT15



SERVICE TYPE	COMMERCIAL EQUIVALENT	SERVICE TYPE	COMMERCIAL EQUIVALENT	SERVICE TYPE	COMMERCIAL EQUIVALENT
CV416	6F17	CV491	12AU7	CV563	DA30
CV417	EC91	CV492	12AX7	CV564	35Z3
CV418	MX2	CV493	6X4	CV565	35Z3GT
CV419	DET18	CV494	B12	CV566	RG-2
CV420	VCRX277	CV495	5802	CV567	35Z5
CV421	CAT20C	CV496	CG14	CV568	35Z5GT
CV422	QS108/45	CV498	NE17	CV569	ECC35
CV423	25SN7GT	CV499	5B/253M	CV570	3Q/195E
CV424	QQV06-40	CV500	6T7	CV571	50L6GT
CV425	CG1-C	CV501	EBF32	CV572	6X5G
CV426	EY51	CV502	LD210	CV573	6X5
CV427	5D21	CV503	5W4	CV574	EZ35
CV428	5B/251M	CV504	6U5	CV575	5U4G
CV429	12AEP26	CV505	MT16	CV576	1B26
CV430	29C1	CV506	GL8023	CV577	1B36
CV431	85A1	CV507	REL64	CV578	6A8G
CV432	ME1400	CV508	1B49	CV579	6A8
CV433	BC/1E	CV509	6V6G	CV580	6A8GT
CV434	QS75/60	CV510	6V6	CV581	6C5G
CV435	GT11	CV511	6V6GT	CV582	6C5
CV436	ACT25	CV512	6W7G	CV583	6C5GT
CV437	KT67	CV513	4J53	CV584	GS46
CV438	G120/1B	CV514	2J36	CV585	6C6
CV439	22/11BXA	CV515	6Y6	CV586	EL37
CV440	1601ABC	CV516	3GP1	CV587	6Q7G
CV441	V1052	CV517	0Z4A	CV588	6Q7
CV442	GEX35	CV518	AC/VP1	CV589	6Q7GT
CV443	CK505AX	CV519	Pen4DD	CV590	6SJ7G
CV444	MZ1-75	CV520	VP2B	CV591	6SJ7
CV445	5J/180E	CV521	R4410	CV592	6SJ7GT
CV446	3Q/260E	CV522	7B7	CV593	GZ32
CV447	4078GA	CV523	12Y4	CV594	6SH7
CV448	GEX54	CV524	TT12	CV595	6SH7GT
CV449	85A2	CV525	12A6	CV596	2C45
CV450	EL38	CV526	12A6GT	CV597	2X2A
CV451	ET3	CV527	DA60	CV598	715C
CV452	6AT6	CV528	VA16	CV599	1851
CV453	6BE6	CV529	12AH7GT	CV600	5CP1
CV454	6BA6	CV530	GT1E	CV601	5BP1
CV455	12AT7	CV531	12C8	CV602	3AP1
CV456	EI633	CV532	GU11	CV603	10
CV458	BTR32	CV533	CAT17C	CV604	30
CV459	BTR34	CV534	12J5	CV605	32
CV460	BS48	CV535	12J5GT	CV606	37
CV461	BS92	CV536	4120/AA	CV607	38
CV462	BS84	CV537	12SA7	CV608	41
CV463	BS82	CV538	12SA7GT	CV609	42
CV464	9L01A	CV539	1B23	CV610	45
CV465	EF72	CV540	12SC7	CV611	56
CV466	EF73	CV541	1B3	CV612	57
CV467	EF70	CV542	5J23	CV613	58
CV468	EC70	CV543	12SK7	CV614	75
CV469	EA76	CV544	12SK7GT	CV615	76
CV470	VX8036	CV545	ACSP3	CV616	77
CV471	EL70	CV546	12SQ7	CV617	80
CV472	EF74	CV547	12SQ7GT	CV618	83
CV473	EY70	CV548	LP2	CV619	84/6Z4
CV474	5643	CV549	25A6	CV620	211
CV475	EF71	CV550	25A6GT	CV621	801
CV476	EF7A	CV551	25L6G	CV622	802
CV477	5899	CV552	25L6	CV623	803
CV478	CG64-H	CV553	25L6GT	CV624	804
CV482	A237	CV554	D63	CV625	805
CV483	QV04-7R	CV555	25Z5	CV626	808
CV484	DL92	CV556	OP75	C.V677	810
CV485	V246A/1K	CV557	D42	CV628	811
CV486	V2046A	CV558	25Z6	CV629	814
CV487	CRT/51	CV559	25Z6GT	CV630	826
CV488	BS90	CV560	TSP4	CV631	828
CV489	BT75	CV561	35L6	CV632	829
CV490	19H5	CV562	35L6GT	CV633	829A

SERVICE TYPE	COMMERCIAL EQUIVALENT	SERVICE TYPE	COMMERCIAL EQUIVALENT	SERVICE TYPE	COMMERCIAL EQUIVALENT
CV634	832	CV705	1D5GP	CV777	1LC5
CV635	833	CV706	6U7	CV778	1LC6
CV636	836	CV707	HK54	CV779	1LD5
CV637	837	CV708	161	CV780	1LH4
CV638	838	CV709	72	CV781	1LN5
CV639	843	CV710	368A	CV782	1R5
CV640	860	CV711	32	CV783	1S4
CV641	861	CV712	38	CV784	1S5
CV642	872A	CV713	1B27	CV785	1T4
CV643	874	CV714	C6A	CV786	1T5
CV644	875A	CV715	6F5GT	CV787	2A7
CV645	876	CV716	8013A	CV788	832A
CV646	879	CV717	5R4GY	CV789	3C24
CV647	884	CV718	5FP7	CV790	2AP1
CV648	885	CV719	2J21A	CV791	2B7
CV649	956	CV720	723A	CV792	2C22
CV650	958	CV722	725A	CV793	2C33
CV651	991	CV723	1619	CV794	2D2
CV652	1603	CV724	816	CV795	2D4A
CV653	1611	CV725	1B24	CV796	2D13C
CV654	1612	CV726	35Z3	CV797	2D21
CV655	1613	CV727	1N21	CV798	2E22
CV656	1616	CV728	1P6GT	CV800	2J22
CV657	1620	CV729	5V4G	CV801	2J54
CV658	1622	CV730	6A3	CV802	2C26
CV659	1625	CV731	6F6GT	CV803	2V3
CV660	6AC7	CV732	6W4GT	CV804	2V3G
CV661	1853	CV733	REL8D	CV805	50Y6
CV662	8012	CV734	228A	CV807	3A4
CV663	8025	CV735	845	CV808	3A5
CV664	9002	CV736	905	CV809	3A/105B
CV665	9003	CV737	906	CV810	3AE
CV666	9004	CV738	953	CV811	1291
CV667	9005	CV739	3AP1	CV812	3B24
CV668	35T	CV740	4MP1	CV813	959
CV669	279A	CV741	5LP1	CV814	3BP1
CV670	HK645	CV742	FG67	CV815	3D6
CV671	8021	CV743	GET2	CV816	3DP1
CV672	706A	CV744	GET4.5	CV817	3EP1
CV673	717A	CV745	HK24	CV818	3Q4
CV674	721B	CV746	468P1	CV819	3Q5GT
CV675	722A	CV747	6AC7	CV820	3S4
CV676	WE726A	CV748	725A	CV821	4A1
CV677	WE701A	CV749	1N23A	CV822	4B24
CV678	702A	CV750	01A	CV823	7A
CV679	703A	CV751	HY75	CV824	4E27
CV680	707A	CV752	0A4G	CV825	4SHA
CV681	708A	CV753	1A3	CV826	4THA
CV682	713A	CV754	1A4P	CV828	4TPB(Clear)
CV683	316A	CV755	1A5G	CV829	4TPB(Met)
CV684	274B	CV756	1A5GT	CV830	4TSP
CV685	VR150-30	CV757	1A6	CV831	5AP1
CV686	0C3	CV758	1B4P	CV832	5AP1
CV687	446B	CV759	1B5	CV833	89
CV688	2C43	CV760	1B7GT	CV834	5B/300B
CV689	700A	CV761	1B22	CV835	5BP1
CV690	RK48A	CV762	1C21	CV836	5BP4
CV691	357A	CV763	1CA4	CV837	12C8
CV692	0Z4	CV764	1D5	CV838	5CP7
CV693	HF300	CV765	1D7G	CV839	5GP1
CV694	12SG7	CV766	1E5GP	CV840	5H4
CV695	700B	CV767	1F4	CV841	5U4GT
CV696	700C	CV768	1F5G	CV842	5W4G
CV697	12SJ7	CV769	1F6	CV843	6AB5
CV698	12SJ7GT	CV770	1F7GV	CV844	6AC5G
CV699	700D	CV771	1G5G	CV845	6AC5GT
CV700	12SR7	CV772	1G6G	CV846	6AC7
CV701	ESA892	CV773	AG6GT	CV847	6AF6G
CV702	830B	CV774	1H4G	CV848	6AG5
CV703	12K8	CV775	1LA6	CV849	6AC7
CV704	RK20A	CV776	1LB4	CV850	6AK5

SERVICE TYPE	COMMERCIAL EQUIVALENT	SERVICE TYPE	COMMERCIAL EQUIVALENT	SERVICE TYPE	COMMERCIAL EQUIVALENT
CV851	6B4	CV927	12Z3	CV1039	IW4-500
CV852	6C4	CV928	13-4	CV1040	PX25
CV854	6C7	CV929	13SPA	CV1041	PM12M
CV855	6C21	CV930	14F7	CV1042	210LF
CV856	6G8G	CV931	15	CV1043	210PG
CV857	6H7	CV932	446A	CV1044	210DDT
CV858	6J6	CV933	15E	CV1045	X56
CV859	6J8G	CV934	15R	CV1046	PT25H
CV860	6K5G	CV936	24A	CV1047	TZ05-20
CV861	6K5GT	CV937	25A7GT	CV1048	210SG
CV862	6L5G	CV938	25AC5GT	CV1049	210SPT
CV864	6P7G	CV939	25B6G	CV1050	HL2K
CV865	6SD7GT	CV940	25B8GT	CV1051	Pen220A
CV866	6SJ7Y	CV941	HK24	CV1052	EL32
CV867	6SR7	CV942	25Y5	CV1053	EF39
CV869	6V5GT	CV943	26	CV1054	EB34
CV870	6V7G	CV944	27	CV1055	EBC33
CV871	6Z5	CV945	28D7	CV1056	EF36
CV872	6Z7G	CV946	28D7GT/G	CV1057	EK32
CV873	6ZY5G	CV947	31	CV1058	EP60
CV874	7	CV948	32L7GT	CV1059	955
CV875	1642	CV949	33	CV1060	807
CV876	7A6	CV950	E4103/B/4	CV1061	DET19
CV877	7A7	CV951	32A	CV1062	TY1-50
CV878	7A8	CV952	4081	CV1064	U12/14
CV879	7B4	CV953	32	CV1065	SP61
CV880	7B5	CV954	20K	CV1066	P61
CV881	7B5LT	CV955	4409	CV1067	6J5
CV882	7B6LM	CV956	4602	CV1068	STV280/40
CV883	7B8LM	CV957	32E	CV1069	STV280/80
CV884	7BP7	CV958	26J	CV1070	7475
CV885	7C5	CV959	20K	CV1071	U52
CV886	7C5LT	CV960	E4504/B/16	CV1072	GU50
CV887	7C6	CV961	V1047	CV1073	H63
CV888	7D7	CV962	E4504/E/16	CV1074	6J7
CV889	7D8	CV964	E4205-B	CV1075	KT66
CV890	7E5	CV966	E4504/M/16	CV1076	DA41
CV891	7E6	CV967	E4103/B/4	CV1077	EM31
CV892	7E7	CV979	DSL10	CV1078	D1
CV893	7F7	CV982	X962106	CV1079	KT8
CV894	7G7	CV983	X961101	CV1080	4307A
CV895	7H7	CV984	S2A	CV1081	4052A
CV896	7K7	CV986	15A	CV1082	220TH
CV897	7J7	CV987	V1040	CV1083	210VTP
CV898	7N7	CV989	41D5	CV1087	14L
CV899	7Q7	CV995	6AJ5	CV1088	832
CV900	7R7	CV996	EL32	CV1089	TV03-10A
CV901	7Y4	CV997	3092	CV1090	E1046
CV902	7W7	CV998	2000T	CV1091	EF50
CV904	892R	CV999	3C22	CV1092	EA50
CV905	9HP7	CV1000	4D1	CV1095	954
CV906	1602	CV1001	SU2150A	CV1096	5B/502A
CV907	12A	CV1002	E1192	CV1097	ECR60
CV908	12A5	CV1018	215SG	CV1098	E960T
CV909	12A7	CV1019	PM2	CV1099	X66
CV991	12A8GT	CV1020	220P	CV1100	KTW62
CV918	12B8GT	CV1021	210LP	CV1101	MHLD6
CV913	12DP7	CV1022	220PA	CV1102	BL63
CV914	12DP8	CV1023	230XP	CV1103	Y63
CV915	12FP7	CV1025	DET25	CV1104	PT15
CV916	12H6	CV1027	210LF	CV1105	ML6
CV917	12J7GT	CV1028	220VSG	CV1106	9D2
CV918	12K7GT	CV1029	ESU150	CV1107	15D2
CV919	12SF5	CV1030	4060A	CV1108	8D2
CV920	12SF5GT	CV1031	ESG250	CV1109	4D1
CV921	12SF7	CV1032	220B	CV1110	S130
CV922	12SH7	CV1034	DET3	CV1111	V1907
CV923	12SJ7GT	CV1035	QP21	CV1112	V1026
CV924	12SL7GT	CV1036	220PA	CV1113	U17
CV925	12SN7GT	CV1037	MH4	CV1114	E1024
CV926	4B35	CV1038	MHL4	CV1116	6F32

SERVICE TYPE	COMMERCIAL EQUIVALENT	SERVICE TYPE	COMMERCIAL EQUIVALENT	SERVICE TYPE	COMMERCIAL EQUIVALENT
CV1117	41MTL	CV1194	X41	CV1318	VS24
CV1118	KT2	CV1195	KTW63	CV1319	PM12V
CV1119	DDL4	CV1196	AC5PenDD	CV1320	SP2
CV1120	SU2150A	CV1197	EC53	CV1321	9D2
CV1121	T41	CV1198	ACP4	CV1322	SP210
CV1122	41MXP	CV1200	202	CV1323	VP2
CV1123	EF8	CV1201	4317	CV1324	SP4
CV1124	MS/Pen	CV1202	304	CV1325	42MPT
CV1125	MS/PenB	CV1205	2587T	CV1326	AC4Pen
CV1126	4SH	CV1206	D060	CV1327	Pen1340
CV1127	Pen46	CV1207	ES450	CV1328	7D8S
CV1128	GT1C	CV1208	PM256	CV1329	APP4G
CV1129	MS/Pen/T	CV1219	MZ1-100	CV1330	TSP4
CV1130	HL23	CV1220	4033L	CV1331	VP23
CV1131	41DS	CV1221	PZ1-75	CV1332	VP21
CV1133	V960	CV1222	ACT6	CV1333	220IPT
CV1134	HVR2	CV1223	DET5	CV1334	KT24
CV1135	DET20	CV1233	DET5	CV1335	SP41
CV1136	EF54	CV1235	DET12	CV1336	SP42
CV1137	EC52	CV1237	PM24D	CV1337	116Pen
CV1138	E4412/B/9	CV1238	PM24D	CV1338	220VPT
CV1140	12MD6	CV1240	PZ1-35	CV1339	KT41
CV1141	GDT4C	CV1246	PM202	CV1340	KT45
CV1142	MR75	CV1250	4279A	CV1341	MSP4
CV1143	GT1A	CV1252	4212E	CV1342	QP25
CV1144	BT19	CV1253	E1161	CV1343	A1065
CV1145	BT9/A	CV1255	E1232	CV1344	TP22
CV1146	BT9-B	CV1256	E1232	CV1345	TP25
CV1147	BT35	CV1257	E1155	CV1347	ECH35
CV1148	E1289	CV1259	ESU450	CV1349	RG5-500
CV1149	BT41	CV1260	ESU208	CV1350	TB3/750
CV1151	PM3	CV1261	RX3-120	CV1351	TB4/1250
CV1152	PM4DX	CV1262	GU1	CV1352	EM80
CV1153	PM254	CV1263	RG1-125	CV1353	OA81
CV1154	PM254	CV1264	U18	CV1354	OA85
CV1155	DEG	CV1265	U15	CV1355	ESU300
CV1156	DEQ	CV1266	U15	CV1356	U22
CV1158	PM14	CV1267	U4020	CV1357	SG250
CV1159	PM14	CV1268	5Y3G	CV1359	ME41
CV1160	104V	CV1279	MU2	CV1361	MZ05-20
CV1161	104V	CV1280	X64	CV1362	DTE25
CV1163	PD220A	CV1281	KTW61	CV1363	DET16
CV1164	ACSG	CV1282	MSP4	CV1364	807
CV1165	VMS4	CV1283	SP4	CV1365	4282BZ
CV1166	P220	CV1284	MS/Pen	CV1366	V248A
CV1167	PM24A	CV1285	6N7G	CV1367	V245
CV1168	PX4	CV1286	EL35	CV1368	V266
CV1169	VMP4G	CV1287	KT32	CV1369	4061A
CV1170	D41	CV1288	DET12	CV1370	PV1-35
CV1171	AT4	CV1289	1561	CV1371	PZ1-35
CV1172	VMP4G	CV1290	SU2150A	CV1372	4069A
CV1173	354V	CV1291	HVR2	CV1373	PY3-600
CV1174	KT42	CV1293	PT6	CV1374	807
CV1175	AP4	CV1296	MU14	CV1375	EF85
CV1176	AP4	CV1300	10D1	CV1376	EF80
CV1177	4D1	CV1301	6H6G	CV1377	GZ34
CV1178	DA30	CV1302	D42	CV1379	20K
CV1179	ML4	CV1303	PM1HF	CV1380	20K
CV1180	V312	CV1304	LP2	CV1382	ACR10
CV1181	KT41	CV1305	4D1	CV1384	41DS
CV1182	MHD4	CV1306	HL23DD	CV1385	E4504/B/16
CV1183	W42	CV1307	PM1LF	CV1386	ACR3
CV1184	A373	CV1308	TDD2A	CV1387	ACR4
CV1186	6F6	CV1309	4019B	CV1388	ACR5
CV1187	D41	CV1310	KC1	CV1389	ACR6
CV1188	N43	CV1311	B406	CV1390	ECR35
CV1189	AC6Pen	CV1312	220RC	CV1391	E4504/E/16
CV1190	ACP4	CV1313	220LF	CV1392	ECR30
CV1191	KTZ41	CV1314	DLS10	CV1393	ACR17
CV1192	Z62	CV1316	4021B	CV1394	ACR18
CV1193	X65	CV1317	S625	CV1396	ECR30

SERVICE TYPE	COMMERCIAL EQUIVALENT	SERVICE TYPE	COMMERCIAL EQUIVALENT	SERVICE TYPE	COMMERCIAL EQUIVALENT
CV1397	E4504/M/16	CV1470	3P/270B	CV1569	R3
CV1400	C1C	CV1471	4049A	CV1570	EK32
CV1401	CL33	CV1472	CMG22	CV1571	VT58A
CV1402	CY31	CV1473	CMG25	CV1572	807
CV1403	DD41	CV1474	CE20	CV1573	4074B
CV1404	EF36	CV1475	M507	CV1574	SP41
CV1405	E1199	CV1476	M507	CV1575	VU71A
CV1406	HL41	CV1477	M507	CV1576	KT38
CV1407	Pen45	CV1478	M501	CV1577	KT44
CV1408	P41	CV1479	M501	CV1578	EF50
CV1409	SP2(Selected)	CV1480	M501	CV1579	954
CV1410	TH2	CV1481	M501	CV1580	E1235
CV1411	TH41	CV1482	M501	CV1581	ECH35
CV1412	TV4	CV1483	M519	CV1582	S130
CV1413	UU6	CV1484	M519	CV1583	E1024
CV1414	VP41	CV1485	M519	CV1584	41MTL
CV1415	4011A	CV1486	M519	CV1585	T41
CV1416	3B/151A	CV1495	M528	CV1586	HL23
CV1417	ES85	CV1496	M528	CV1587	ECR35
CV1418	10D1	CV1497	M528	CV1588	ECR30
CV1419	11D3	CV1498	M528	CV1592	E4504/C/16
CV1420	4078A	CV1499	M528	CV1596	09D
CV1421	XP1.5	CV1500	M528	CV1597	E4103/B/4
CV1422	3D/10A	CV1501	E1192	CV1598	41DS
CV1423	9D2	CV1502	KT32	CV1599	SC13C
CV1424	20A1	CV1503	KT33C	CV1600	CAT1
CV1425	7D5	CV1504	V1901	CV1601	CAR1
CV1426	EK2	CV1505	MH41	CV1602	CAR4
CV1427	EF9	CV1506	ESP450	CV1603	4104A
CV1428	EBC3	CV1507	V1507	CV1604	SS1971
CV1429	EL2	CV1508	V1913	CV1605	4013C
CV1430	ACSP3	CV1510	E1242	CV1606	CAT2
CV1431	ACT16	CV1515	MX1	CV1607	0C2.5
CV1432	CMG8	CV1516	PMD6	CV1608	U4
CV1433	EC31	CV1517	E4504/C/16	CV1609	SW7
CV1434	EM4	CV1518	09D	CV1610	MT4
CV1435	GU2	CV1519	V1042	CV1611	MR4
CV1436	HL2	CV1521	E4412/M/9	CV1612	VT9B
CV1437	E1143	CV1522	E413/B/4	CV1614	ES1500A
CV1438	KT61	CV1525	E4205/C/7	CV1615	ESU1500
CV1439	MT9F	CV1526	3EG1	CV1618	ES250M
CV1440	MT9L	CV1527	VLS492AG	CV1619	4212E
CV1441	MT12A	CV1529	E4412/E/9	CV1620	DET6
CV1442	MT14	CV1530	6LY1	CV1621	ESW501
CV1443	R1	CV1535	EZ80	CV1622	4052A
CV1444	42SPT	CV1536	1608ABA	CV1623	RG1-125
CV1445	4012A	CV1537	3ACP2	CV1624	P21-75
CV1446	4017B	CV1538	5J32	CV1625	RG3-250
CV1447	4030D	CV1539	D15	CV1626	RG1-240A
CV1448	4043C	CV1540	33B/152M	CV1627	5D/100A
CV1449	4064B	CV1543	12MD6	CV1628	GU8
CV1450	4228A	CV1546	12MD6	CV1629	RG3-1250A
CV1451	3274A	CV1548	41DS	CV1630	5C/450A
CV1452	4300A	CV1550	VT1A	CV1632	1N82
CV1453	4378	CV1551	VT1C	CV1633	3V4
CV1454	225DU	CV1552	VX3B	CV1634	XB2
CV1455	41IU	CV1553	VT4B	CV1635	5A/163K
CV1456	Pen383	CV1554	VT5B	CV1636	LS5
CV1457	VP133	CV1555	VU6A	CV1637	LS5
CV1458	41MP	CV1557	VT9B	CV1638	4101D
CV1459	MU2	CV1558	VT10D	CV1639	4101E
CV1460	X41	CV1559	VR12C	CV1640	4102D
CV1461	U22	CV1560	VR12F	CV1641	4102E
CV1462	A915	CV1561	VT12B	CV1642	DER
CV1463	CBL31	CV1562	VT13C	CV1643	EI32
CV1464	EF39	CV1563	VR14A	CV1644	E153
CV1465	T250	CV1564	VU16A	CV1645	E133
CV1466	P57	CV1565	230XP	CV1646	E1453
CV1467	PY3-600	CV1566	VR24B	CV1647	LS5B
CV1468	SP4	CV1567	2C25	CV1648	4205E
CV1469	Z22	CV1568	4062A	CV1649	6C5

SERVICE TYPE	COMMERCIAL EQUIVALENT	SERVICE TYPE	COMMERCIAL EQUIVALENT	SERVICE TYPE	COMMERCIAL EQUIVALENT
CV1650	LS5A	CV1722	A901	CV1795	723A/B
CV1651	G455B	CV1723	V257	CV1796	DW4/350
CV1652	P220A	CV1724	5A/102D	CV1797	4081A
CV1653	3A/108A	CV1725	4328D	CV1798	2051
CV1654	210LF	CV1726	5A/105A	CV1799	350B
CV1655	3A/107B	CV1727	Z22	CV1800	1A7G
CV1656	LS8	CV1728	WE262B	CV1801	GS118
CV1657	4020B	CV1729	KTW62	CV1802	1A7GT
CV1658	LS9B	CV1730	KT66	CV1803	1C5G
CV1659	4022B	CV1731	S130	CV1804	EAC91
CV1660	LS7	CV1732	ML4	CV1805	DL35
CV1661	DL	CV1733	4108AG	CV1806	1D5GT
CV1662	P215	CV1734	3Q/213E	CV1807	2J31
CV1663	4021B	CV1735	DC2P	CV1808	2J32
CV1664	B406	CV1737	MW6-2	CV1809	2J33
CV1665	DH	CV1738	R5161	CV1810	3J34
CV1666	P610	CV1739	GC10/4B	CV1811	1D8GT
CV1667	LS5X	CV1740	GS12C	CV1812	1E7GT
CV1668	E420	CV1741	EL34	CV1813	2DP1
CV1669	P625	CV1742	BK44	CV1814	5LP1
CV1670	HL1320	CV1743	BS64	CV1815	6Q5G
CV1671	4021A	CV1744	15L01A	CV1816	6Y3G
CV1672	Pen36C	CV1745	62BT	CV1817	1G4GT
CV1673	PM2HL	CV1746	30C12P1	CV1818	1H5GT
CV1674	AC/S2/Pen	CV1747	M505	CV1819	6P5GT
CV1675	N43	CV1748	TTR31MC	CV1820	1H5GT
CV1676	LS8A	CV1749	205D	CV1821	1N5G
CV1677	MS4B	CV1750	33A/100A	CV1822	2J48
CV1678	HLA2	CV1751	34	CV1823	1N5GT
CV1679	DA30	CV1752	35	CV1824	1Q5G
CV1680	PM202	CV1753	35A5LT	CV1825	KT45
CV1681	TSP4	CV1754	35TG	CV1826	1Q5GT
CV1683	MKT4	CV1755	1626	CV1827	M510
CV1684	APP4C	CV1756	1629	CV1828	M512
CV1685	APP4C	CV1757	9001	CV1829	1T5GT
CV1686	D418	CV1758	1L4	CV1830	1B3GT
CV1687	D418	CV1759	2C26A	CV1831	2A3
CV1688	4033L	CV1760	2J26	CV1832	0A2
CV1689	PA1	CV1761	3FP7	CV1833	0B2
CV1690	9A1	CV1762	6AK6	CV1834	2A5
CV1691	DDL4	CV1763	6J4	CV1835	3B28
CV1692	AC/P	CV1764	CE2	CV1836	4B26
CV1693	PP3/250	CV1765	5664	CV1837	2B7
CV1694	3A/144A	CV1766	CX25	CV1838	QQZ04-15
CV1695	DDL13	CV1768	707B	CV1839	6F13
CV1696	B21	CV1769	2A6	CV1841	BS52
CV1697	X41	CV1770	7A4	CV1842	2G
CV1698	A819	CV1771	39/44	CV1843	2Y2
CV1699	SP41	CV1772	47	CV1844	GS3/B
CV1700	SP41	CV1773	82	CV1846	5T4
CV1701	XLO	CV1774	112A/12A	CV1847	19H4
CV1702	XP	CV1775	36	CV1848	20A2
CV1703	XW	CV1776	6D7	CV1849	5W4
CV1704	57	CV1777	7C7	CV1850	6L19
CV1705	58	CV1778	101D	CV1851	5X4G
CV1706	2B7	CV1779	102D	CV1852	5X4
CV1707	2A5	CV1780	30TWIN	CV1853	6P25
CV1708	80	CV1781	310B	CV1854	5Y3G
CV1709	6D6	CV1782	340A	CV1855	UU9
CV1710	6C6	CV1783	9JP1	CV1856	5Y3GT
CV1711	6B7	CV1784	6AK7	CV1857	5Y4G
CV1712	42	CV1785	1N26	CV1858	BS62
CV1713	EF8	CV1786	2K33	CV1859	BS4A
CV1714	EF9	CV1787	4C35	CV1860	30D5
CV1715	EBC3	CV1788	3J31	CV1861	5Z3
CV1716	E1541	CV1789	5FP14	CV1862	6AQ5
CV1717	4307A	CV1790	7Z4	CV1863	5Z4G
CV1718	AC/TP	CV1791	5JP1	CV1864	5Z4
CV1719	U22	CV1792	1960	CV1865	EC81
CV1720	XL1.5	CV1793	724B	CV1866	M503
CV1721	XP1.5	CV1794	959	CV1867	6A6

SERVICE TYPE	COMMERCIAL EQUIVALENT	SERVICE TYPE	COMMERCIAL EQUIVALENT	SERVICE TYPE	COMMERCIAL EQUIVALENT
CV1868	5T01A	CV1946	6K8GT	CV2022	6BW6
CV1869	12T01A	CV1947	6L6G	CV2023	9D6
CV1870	6A7	CV1948	6L6	CV2024	6BE6
CV1871	K307	CV1949	6D4	CV2025	EF91
CV1873	6AB7	CV1950	6L7G	CV2026	6BA6
CV1876	1852	CV1951	6L7	CV2029	G180/2G
CV1878	6AD7G	CV1952	VCRX267	CV2101	DF72
CV1879	HP4101	CV1953	6N6G	CV2102	DL75
CV1880	7BM1A	CV1954	6N6	CV2103	DF73
CV1881	VX4144	CV1955	EF91	CV2104	DAF70
CV1882	6AG7	CV1956	6N7G	CV2105	DL70
CV1883	4H/180E	CV1957	6N7	CV2106	DL66
CV1884	33A/158M	CV1958	6N7GT	CV2107	DF66
CV1885	6B5	CV1959	50C5	CV2108	9M06A
CV1886	EC80	CV1960	6R6G	CV2109	VX4099
CV1887	6B6	CV1961	12AU6	CV2110	BT83
CV1888	EC81	CV1962	6R7G	CV2115	U41
CV1889	TYS4-500	CV1963	6R7	CV2116	VX5029
CV1891	6B7	CV1964	6R7GT	CV2124	BK24
CV1892	2K28	CV1965	ET30	CV2125	BD78
CV1893	6B8G	CV1966	6SA7G	CV2126	3V/420B
CV1894	6B8	CV1967	6SA7GT/G	CV2127	6CH6
CV1895	STV/70/60	CV1968	CWS24A	CV2128	6AJ8
CV1896	6C8G	CV1969	6SC7	CV2129	5763
CV1897	4J34	CV1970	6SC7GT	CV2130	TT16
CV1898	4J35	CV1971	1T4	CV2131	6156
CV1899	6L18	CV1972	6SF5	CV2132	90AV
CV1900	6D6	CV1973	6SF5GT	CV2133	90CG
CV1901	6F11	CV1974	6S7G	CV2134	90CV
CV1902	6D8G	CV1975	6S7	CV2135	8D5
CV1903	592	CV1976	MV6-5	CV2136	6BW6
CV1904	CAA322	CV1977	UL41	CV2137	E4504/M/16
CV1905	4-65A	CV1978	6SG7	CV2138	GM4
CV1906	6E5	CV1979	61BT	CV2139	EHM2
CV1907	CS2-C	CV1980	185BT	CV2140	B6
CV1908	6F5G	CV1981	6SK7	CV2141	B6E
CV1909	6F5	CV1982	6SK7GT	CV2142	B12E
CV1910	6F5GT	CV1984	6SC7	CV2143	B24
CV1911	6F6G	CV1985	6SL7GT	CV2144	B24E
CV1912	6F6	CV1986	6SN7	CV2145	M6
CV1913	GS44X	CV1988	6SN7GT	CV2146	DM6
CV1914	4J31	CV1989	SD6	CV2147	G24H
CV1915	6F7	CV1990	6SQ7	CV2148	GM5B
CV1916	4J33	CV1991	6SQ7GT	CV2149	GM1B
CV1917	6F8G	CV1992	1267	CV2150	MX103
CV1918	6F8	CV1993	6SS7	CV2151	MX105
CV1919	6F14	CV1995	6ST7G	CV2152	MX107
CV1920	6LD20	CV1996	6ST7	CV2153	MX108
CV1921	U24	CV1997	VCRX307	CV2154	S1M2
CV1923	TTR31MR	CV1999	1V	CV2155	S1M5
CV1924	TY2-125	CV2000	5A/159M	CV2158	VX3166
CV1926	6G6G	CV2001	EF91	CV2159	BR153
CV1927	B142	CV2002	6AM5	CV2160	A207
CV1928	12BA6	CV2003	6AM5	CV2161	K301
CV1929	6H6G	CV2004	6AL5	CV2162	12L01A
CV1930	6H6	CV2005	6AL5	CV2163	ACT28
CV1931	6H6GT	CV2006	EF55	CV2164	K302
CV1932	6J5G	CV2007	12AU7	CV2166	4J50
CV1933	6J5	CV2008	A1714	CV2167	VX4080
CV1934	6J5GT	CV2009	6AQ4	CV2171	A2087
CV1935	6J7G	CV2010	6J6	CV2172	DC80
CV1936	6J7	CV2011	12AX7	CV2173	G10H
CV1937	6J7GT	CV2012	85A2	CV2174	G240/2D
CV1938	6K6G	CV2013	6CH6	CV2175	DG7-5
CV1939	37X50	CV2014	6062	CV2179	E2134
CV1940	6K6GT	CV2015	DDR2	CV2180	19H4
CV1941	6K7G	CV2016	12AT7	CV2181	BS104
CV1942	6K7	CV2017	VX3098	CV2183	X661
CV1943	6K7GT	CV2018	95A1	CV2184	VCRX298
CV1944	6K8G	CV2019	150B3	CV2185	88D
CV1945	6K8	CV2020	6AK5	CV2186	VX4073

SERVICE TYPE	COMMERCIAL EQUIVALENT	SERVICE TYPE	COMMERCIAL EQUIVALENT	SERVICE TYPE	COMMERCIAL EQUIVALENT
CV2187	Z239/1G	CV2266	CC3L	CV2346	VX5028
CV2188	W7/2D	CV2267	F/6063	CV2347	5B/258M
CV2189	V240C/2K	CV2268	F/6064	CV2348	5889
CV2190	V233A/1K	CV2269	ME1401	CV2349	EN30
CV2191	DG13/2	CV2270	90AG	CV2350	VX9005
CV2192	9MW5AX	CV2271	GC10B	CV2352	DG16-22
CV2193	89D	CV2272	VCRX212	CV2353	R6J010
CV2194	G400/1K	CV2273	K312	CV2354	R6015
CV2195	EF91	CV2274	BS114	CV2358	W7/1D
CV2196	VX3078	CV2275	DC70	CV2360	5A6
CV2197	E1024	CV2276	Z319	CV2361	DL69
CV2198	VX9031	CV2277	13E1	CV2362	M525
CV2199	GC10A	CV2278	VCRX353	CV2363	M525
CV2200	VX3098	CV2280	3EG1	CV2364	M525
CV2201	TD4.5-10	CV2281	M537	CV2365	M525
CV2202	XE2	CV2282	K308	CV2366	MS25
CV2203	GHT1	CV2283	VX7069	CV2367	M525
CV2204	TD03-10F	CV2284	4J50	CV2368	M525
CV2205	E4103/E/4	CV2285	VX3146	CV2369	AA76
CV2206	EY70	CV2286	E4412/E/9	CV2370	3S4
CV2207	VX3147	CV2287	G12H	CV2371	DF61
CV2208	G50/1G	CV2288	DL66	CV2372	MF22-75
CV2209	6F33Special-5A/201K	CV2289	U37	CV2373	M502A
CV2210	5544	CV2290	GEX36	CV2374	GD60
CV2211	408CAHA	CV2291	1909A	CV2375	GD100
CV2212	13D3	CV2292	VCRX173	CV2376	M521
CV2213	NT2	CV2293	XB-1	CV2377	13E1
CV2214	3B/240M	CV2294	VX9046	CV2378	TRP4
CV2215	5545	CV2295	3E29	CV2379	TRP5
CV2216	30E8/P1	CV2296	NSP2	CV2380	MAG8
CV2217	6K25	CV2297	VX3154	CV2381	N1034
CV2218	6157	CV2298	E1024	CV2382	EL822
CV2220	5B/257M	CV2299	DL73	CV2383	BR191
CV2221	V235A-1K	CV2300	3A4(Selected)	CV2384	ZS10C
CV2222	VCRX312	CV2301	E4412/C/9	CV2385	S11E12
CV2223	G10/241/E	CV2302	1CP1	CV2386	VX9022
CV2224	G1/371K	CV2303	VX3153	CV2387	VX8084
CV2225	150B2	CV2304	K324	CV2388	VCRX397A
CV2229	M502A	CV2305	VCRX351	CV2389	CXT1
CV2230	VCRX361	CV2306	BS122	CV2390	3A4
CV2231	E2266	CV2307	BS120	CV2391	VX3136
CV2232	DDX52	CV2308	BS116	CV2392	VX3171
CV2233	G5H	CV2309	BS118	CV2393	BA9-20
CV2234	X662	CV2310	GEX64	CV2394	DA42
CV2235	EY84	CV2311	VX9076	CV2395	TD03-10
CV2236	Z800U	CV2312	VX9075	CV2396	1B23
CV2237	1AD4	CV2313	VX4122	CV2397	DET29
CV2238	5672	CV2314	MP31-55	CV2398	VX3518
CV2239	5676	CV2315	C12B	CV2399	AX228
CV2240	3B4	CV2316	6097B	CV2400	CXT2
CV2241	DY70	CV2317	6097C	CV2411	VX8194
CV2242	VX7052	CV2318	A2272	CV2412	M253
CV2243	PSG8-5A/206K	CV2319	VX4061	CV2413	SX642
CV2244	VCRX258	CV2320	VX4061	CV2414	XC305/1
CV2245	3J/160E	CV2321	GD86W/S	CV2415	VCRX225
CV2246	DDX52	CV2322	BR161	CV2416	C1133
CV2247	G5H	CV2323	BR179	CV2418	GHT2
CV2248	VX9115	CV2324	CR176	CV2419	3EG1
CV2249	VX9112	CV2325	Z502S	CV2420	JPT9-01
CV2250	VX9054	CV2326	VX3143	CV2421	JPT9-02
CV2251	VX9113	CV2327	MX103	CV2422	VX7104
CV2252	VX9114	CV2328	MF31-95	CV2424	M549
CV2253	ME1501	CV2329	4004B	CV2425	M539
CV2254	5678	CV2330	VX9106	CV2426	M529
CV2255	Z801U	CV2331	DL64	CV2428	25110
CV2256	X662	CV2332	VCRX359	CV2429	TRP6
CV2257	UD166C	CV2338	F2	CV2430	TRP3
CV2258	CS4B	CV2340	VX9151	CV2431	DG7-32
CV2259	DL68	CV2341	VX3138	CV2432	6205
CV2260	DF64	CV2342	VCRX364	CV2433	DF63
CV2263	K305	CV2343	K335	CV2434	6779



SERVICE TYPE	COMMERCIAL EQUIVALENT	SERVICE TYPE	COMMERCIAL EQUIVALENT	SERVICE TYPE	COMMERCIAL EQUIVALENT
CV2435	1601M	CV2551	100TH	CV2629	350A
CV2447	X1	CV2552	100TH	CV2630	351A
CV2448	7182	CV2553	101F	CV2631	352A
CV2449	7182	CV2554	111A	CV2632	354A
CV2450	7182	CV2556	117L7GT	CV2633	262A
CV2451	7182	CV2557	117N7GT	CV2634	367
CV2452	7182	CV2558	117Z6GT/G	CV2636	375A
CV2453	A2521	CV2560	121A	CV2637	388A
CV2455	VX138	CV2561	122A	CV2638	393A
CV2465	5B/251M	CV2562	164V	CV2639	394A
CV2466	QQV02-6	CV2563	204A	CV2640	405BU
CV2469	VCRX407	CV2565	2050	CV2642	417A
CV2473	M538A	CV2566	205E	CV2643	2C40
CV2480	VX1002	CV2567	205F	CV2644	460BU
CV2484	VX1009MK5	CV2569	210DET	CV2645	506BU
CV2486	XC18	CV2570	210HF	CV2647	532
CV2487	QV2-250B	CV2571	210HL	CV2648	532A
CV2492	E88CC	CV2572	450TH	CV2650	12AY7
CV2493	E88CC/01	CV2573	5651	CV2651	707B
CV2494	VA2018	CV2574	210VPA	CV2652	709A
CV2497	MG13-11	CV2575	5670	CV2653	7MAY
CV2498	DPI6-22	CV2576	211SP	CV2654	715A
CV2499	VX7147	CV2577	212E	CV2655	715B
CV2500	35Z4GT	CV2578	5687	CV2656	724A
CV2501	40	CV2579	218	CV2657	800
CV2502	41FP	CV2580	220C	CV2658	806
CV2503	41MH	CV2581	2200T	CV2659	3D21A
CV2504	41MHL	CV2582	220VS	CV2660	809
CV2505	41MPG	CV2584	231D	CV2661	812
CV2506	41MPT	CV2585	39	CV2662	5639
CV2507	1U4	CV2586	240B	CV2663	815
CV2508	41STH	CV2587	242C	CV2664	822
CV2509	41FP	CV2588	244A	CV2665	825
CV2510	1Z2	CV2589	250TH	CV2666	829B
CV2511	420T	CV2591	RK38	CV2668	846
CV2512	420TDD	CV2592	256B	CV2669	849
CV2514	43	CV2593	257A	CV2670	849H
CV2516	2C39A	CV2594	258B	CV2671	851
CV2517	2E30	CV2595	259A	CV2672	852
CV2518	4B32	CV2597	262A	CV2673	857B
CV2519	4X150A	CV2598	264A	CV2674	863
CV2520	5C22	CV2599	264C	CV2675	864
CV2521	6AH6	CV2600	267B	CV2676	865
CV2522	6AS6	CV2601	271A	CV2678	5799
CV2523	6AS7G	CV2602	272A	CV2679	866JR
CV2524	6AU6	CV2603	274A	CV2680	868
CV2526	6AV6	CV2604	275A	CV2683	878
CV2527	6BA7	CV2605	282A	CV2685	880
CV2528	45DS	CV2606	284	CV2686	889
CV2529	451U	CV2607	284D	CV2687	889R
CV2530	45Z5GT	CV2608	300A	CV2688	891R
CV2531	46	CV2609	300B	CV2689	893R
CV2532	49	CV2610	3030	CV2690	904V
CV2533	50	CV2611	304TH	CV2691	913
CV2534	50L6G	CV2612	307A	CV2692	918
CV2535	53	CV2613	310A	CV2693	929
CV2536	53A	CV2614	311A	CV2694	930
CV2537	55	CV2615	313C	CV2695	931
CV2538	59	CV2616	314A	CV2696	931A
CV2539	61P	CV2617	323A	CV2697	935
CV2540	63D	CV2618	327A	CV2698	5896
CV2541	71A	CV2619	328A	CV2699	6088
CV2542	72	CV2620	329A	CV2700	957
CV2543	73	CV2621	330B	CV2701	958A
CV2544	78	CV2622	331A	CV2704	7E5
CV2545	79	CV2623	332A	CV2705	1203
CV2546	81	CV2624	337A	CV2706	7C4
CV2547	83V	CV2625	338A	CV2707	1231
CV2548	84	CV2626	346A	CV2709	1R4
CV2549	85	CV2627	349A	CV2710	3D6
CV2550	100T	CV2628	349B	CV2711	MOOT

SERVICE TYPE	COMMERCIAL EQUIVALENT	SERVICE TYPE	COMMERCIAL EQUIVALENT	SERVICE TYPE	COMMERCIAL EQUIVALENT
CV2712	1609	CV2800	A40	CV2875	CL4
CV2713	1610	CV2801	A40/N3	CV2876	2D21W
CV2714	1614	CV2803	Z915	CV2877	6AK5W
CV2715	1630	CV2804	A915A	CV2878	CRT1
CV2716	6SC7(Selected)	CV2805	A924	CV2879	CRT2
CV2717	1729	CV2806	AC2/HC	CV2880	CRT4/1
CV2718	1876	CV2807	AC2HL	CV2882	6AL5W
CV2719	1924	CV2808	AC2Pen	CV2883	6AQ5W
CV2720	ESU111	CV2809	AC5Pen	CV2884	6AS6
CV2721	6CJ6	CV2810	E4504/M/16	CV2885	54NCP11
CV2722	3025	CV2811	AC/HL	CV2886	M2H
CV2723	869B	CV2812	AC/HL	CV2887	DAC1
CV2725	3209	CV2813	AC/HLDD	CV2888	EL31
CV2726	6CK6	CV2814	5D21	CV2889	DD620
CV2727	26D	CV2815	ACP	CV2890	DDT
CV2728	29D	CV2816	3JP12	CV2891	DE5
CV2729	E80F	CV2817	6L6GA	CV2892	DE5B
CV2730	5880	CV2818	AC/PT8	CV2895	DET1SW
CV2731	63DS	CV2819	AC/S	CV2896	52CG
CV2733	3951	CV2820	AC/SP1	CV2897	C211QX/2
CV2734	4033A	CV2821	ECC33	CV2898	DET8
CV2735	4015A	CV2822	AC/SG	CV2899	DET9
CV2736	3C24	CV2823	AC/SP3	CV2900	DET10
CV2738	RG1-240	CV2824	AC/SPen	CV2901	EF86
CV2742	114	CV2825	ACT6	CV2902	GX402
CV2743	4033AF	CV2826	1B63A	CV2903	0A2
CV2744	4J34(Selected)	CV2827	ACT10	CV2905	3J/170E
CV2745	4050AG	CV2829	1N34	CV2907	DF1
CV2746	4064A	CV2830	AC/TH1	CV2908	3J/260E
CV2747	6U5G	CV2831	2C51	CV2909	DH73M
CV2748	5Z4GT	CV2832	AC/VP2	CV2910	DK1
CV2749	4081	CV2833	AF3	CV2911	DL2
CV2750	89J	CV2834	AGT1	CV2912	DL63
CV2751	4096AB	CV2835	5R4WGY	CV2913	DL51
CV2752	4PR60A	CV2836	APP4G	CV2914	1B40
CV2753	5684	CV2837	APP4G	CV2916	1N25
CV2754	5685	CV2838	AR	CV2918	1N28
CV2755	4251AX	CV2839	AR300	CV2919	1N43
CV2756	4260A	CV2840	5UP7	CV2920	E1148
CV2759	4304	CV2841	ARP12T	CV2923	1N69
CV2760	4304B	CV2842	6C4W	CV2924	1N70
CV2761	4304BB	CV2843	6J6W	CV2925	EBF2
CV2762	4316A	CV2844	6X4W	CV2926	EBL31
CV2764	4606	CV2845	LS5	CV2927	EC50
CV2765	4673	CV2846	LS5B	CV2928	1N81
CV2766	4687	CV2847	5704	CV2929	ECH3
CV2767	4690	CV2848	CK707	CV2930	ECH33
CV2768	8003	CV2849	K1051	CV2931	2B22
CV2769	9006	CV2850	AT200A	CV2932	2C42
CV2770	13077	CV2851	3D22	CV2933	2C46
CV2772	23043	CV2852	2J56	CV2934	3BP1A
CV2773	68503	CV2853	RZ1-250	CV2935	3JP1
CV2774	68504	CV2854	6AN5	CV2936	4B22
CV2775	68506	CV2855	6K4	CV2937	6AQ6
CV2776	68510	CV2856	1N23B	CV2938	EL33
CV2777	4B28	CV2857	1N23BM	CV2939	6F4
CV2778	2J21A	CV2858	3B24W	CV2940	EL36
CV2779	4B36	CV2859	5846	CV2941	EL50
CV2786	26J	CV2860	AZ1	CV2942	EM1
CV2788	NT13	CV2861	AZ2	CV2943	ESU76
CV2789	9LP7	CV2862	AZ31	CV2944	ESU1500
CV2790	C1K	CV2864	B21	CV2945	ESU75
CV2791	K322	CV2865	B30	CV2946	ESU150
CV2792	2K25	CV2866	2C51W	CV2947	ESU300
CV2793	2J50	CV2867	BU100/6	CV2948	ESU450
CV2794	C10SS/2G	CV2868	C1A	CV2949	F123A
CV2795	1L4	CV2869	3JP7	CV2950	129B
CV2796	6L6WGB	CV2870	CC3D	CV2952	FA13
CV2797	QQV06-40A	CV2871	CAT6	CV2953	FA14
CV2798	QQV03-10	CV2872	CAT9	CV2954	FC2A
CV2799	QQV03-20	CV2874	1005	CV2955	FC4

SERVICE TYPE	COMMERCIAL EQUIVALENT	SERVICE TYPE	COMMERCIAL EQUIVALENT	SERVICE TYPE	COMMERCIAL EQUIVALENT
CV2956	FC13C	CV3531	L2	CV3609	5517
CV2957	FG17	CV3532	L21	CV3610	5663
CV2958	FG278	CV3533	L22DD	CV3611	5586
CV2959	3B21	CV3534	L30	CV3612	5686
CV2960	FP54	CV3535	C14HM	CV3613	6AR6
CV2961	1N54A	CV3536	LS408A	CV3614	6BL6
CV2962	1N38A	CV3537	L600	CV3615	6BM6
CV2963	4-125A	CV3538	L610	CV3616	6BN6
CV2964	4-250A	CV3539	6024	CV3618	6L6WGA
CV2965	RL7076-2B	CV3540	HT415	CV3619	6SJ7WGT
CV2966	EY86	CV3541	LS6A	CV3620	P220
CV2967	8020	CV3542	LS532	CV3621	P410
CV2968	7F8	CV3543	4D32	CV3622	P610
CV2969	GT1	CV3544	SD432	CV3623	PA40
CV2970	5656	CV3545	5939	CV3624	PE7B
CV2971	5675	CV3546	MHD4	CV3625	PE8
CV2972	5876	CV3547	MH14	CV3626	PenB4
CV2973	GU7	CV3548	1B24A	CV3627	6SN7WGT
CV2974	1N72	CV3549	1B38	CV3628	1B35A
CV2975	6BQ5	CV3550	1B41	CV2639	6130
CV2976	NE	CV3551	1N38	CV3630	Pen44
CV2977	H2	CV3552	MPT4K	CV3631	Pen45DD
CV2978	H12	CV3553	MS4B	CV3632	6131
CV2979	H30	CV3554	MPT42	CV3633	Pen231
CV2980	DM70	CV3555	1Q22	CV3634	Pen428
CV2981	H410	CV3557	MR300	CV3635	Pen1340
CV2982	H610	CV3558	MR300/E	CV3636	Pen1346
CV2983	DL94	CV3559	2C53	CV3637	7BP7A
CV2984	6080	CV3560	2J51	CV3638	PenA4
CV2985	HD24	CV3561	MS/Pen	CV3639	7UP7
CV2986	HD203A	CV3562	MSP41	CV3640	PJ8
CV2987	HF100	CV3563	MT11SW	CV3641	PM1HL
CV2988	HF200	CV3564	MT12	CV3642	PM1LF
CV2989	HK354E	CV3565	ME41	CV3643	PM2A
CV2990	6136	CV3567	MU1	CV3644	726C
CV2991	HL2	CV3569	2J42	CV3645	PM2DX
CV2992	6106	CV3570	MU4250	CV3646	845W
CV2993	KU25	CV3571	MVSPen	CV3647	PM22A
CV2994	HL23	CV3572	MVSPenB	CV3648	PM24E
CV2995	HL23DD	CV3573	MZ05-20	CV3649	PM22
CV2996	HL41DD	CV3574	MZ17/76	CV3650	12AY7
CV2997	HL63	CV3575	3B26	CV3651	12SH7GT
CV2998	HL133	CV3576	MX40	CV3652	PT5
CV2999	HL133DD	CV3577	25A7GT	CV3653	PT6
CV3500	HL210	CV3578	PM22D	CV3654	PT11
CV3501	HL610	CV3579	PT5E	CV3655	12SP7
CV3502	HL1320	CV3580	304TL	CV3656	PT425
CV3503	HLDD1320	CV3581	V1501	CV3657	PV05-15
CV3506	HY615	CV3582	VP4B	CV3658	PV1-35
CV3508	6201	CV3583	5HP1	CV3659	M510A
CV3509	1N31	CV3584	21/2	CV3660	M510A
CV3510	4B31	CV3586	471A	CV3661	M501A
CV3511	371B	CV3587	705A	CV3662	M501A
CV3512	5696	CV3588	706A	CV3666	12SW7
CV3514	K8140824	CV3589	707A/B	CV3667	RG1-250
CV3515	KB2	CV3590	708A	CV3668	12SY7
CV3516	KK2	CV3592	UX6653	CV3669	2K48
CV3517	5933	CV3593	713A	CV3670	RG4-1000
CV3518	5948/1754	CV3594	717A	CV3671	RK25
CV3519	KT30	CV3595	721A	CV3672	RK28
CV3520	KT31	CV3596	722A	CV3673	RK28A
CV3521	5949/1907	CV3597	726B	CV3674	RK31
CV3522	6079	CV3599	829B	CV3675	9004
CV3523	6146	CV3600	902P1	CV3676	2J42
CV3524	G1/235G	CV3601	7193	CV3677	RK47
CV3525	1N21C	CV3602	5J26	CV3678	2BP1
CV3526	EL85	CV3604	GL464	CV3679	RK49
CV3527	KTW73M	CV3605	GL464	CV3680	RK60
CV3528	M513	CV3606	5J29	CV3681	RK62
CV3529	KTZ41	CV3607	NP90	CV3683	RKR47
CV3530	KTZ73	CV3608	5J30	CV3685	QK283

SERVICE TYPE	COMMERCIAL EQUIVALENT	SERVICE TYPE	COMMERCIAL EQUIVALENT	SERVICE TYPE	COMMERCIAL EQUIVALENT
CV3686	QK284	CV3768	V503	CV3844	5J31
CV3687	2J49	CV3769	V877	CV3845	RS366
CV3688	2C33	CV3770	V955	CV3846	RS261
CV3689	3B29	CV3772	V970	CV3847	RS250
CV3690	RZ1-150	CV3773	V1010	CV3848	RS260
CV3691	S23	CV3774	V1020	CV3849	RS217
CV3692	S23	CV3775	V1021	CV3850	RS207
CV3693	10KP7	CV3776	V1023	CV3851	RS253
CV3694	S130A	CV3777	V1029	CV3852	RS285
CV3695	S215	CV3778	V1105	CV3853	RS15
CV3696	S215A	CV3779	4J26	CV3854	RS47
CV3697	12SX7GT	CV3780	4J27	CV3855	RS329
CV3698	S610	CV3781	4J28	CV3856	RS330
CV3699	5693	CV3782	4J29	CV3857	RS283A
CV3702	SG215	CV3783	4J30	CV3858	RS18
CV3703	SP4B	CV3784	5B/102A	CV3859	RV271A
CV3704	SP13C	CV3785	VMP4G	CV3860	RS282
CV3705	5691	CV3786	VMP4G	CV3861	RS281
CV3706	5796	CV3787	VP2	CV3862	RS55
CV3707	6AL7GT	CV3788	VP4	CV3863	RS289
CV3709	STV150/200	CV3789	5842	CV3864	RS389
CV3710	AR63	CV3790	VP13C	CV3865	RS288
CV3711	N78	CV3791	VP21	CV3866	RS203
CV3712	STV280/80A	CV3792	VP23	CV3867	RG44
CV3714	822Special	CV3793	VP24	CV3868	RSQ15/40
CV3715	SW5	CV3794	VP210	CV3869	RSQ15/5
CV3719	SW7	CV3795	VP215	CV3870	RGQ10/4D
CV3721	T4D	CV3796	VP1322	CV3871	RS254
CV3722	T20	CV3797	V944A	CV3872	RS255
CV3723	T41	CV3798	OA3	CV3873	RS566
CV3724	T200	CV3799	OB3	CV3874	ATR388
CV3725	GL446	CV3800	VS2	CV3875	KU54
CV3726	TDD2A	CV3802	VS24	CV3876	SAL39
CV3727	TDD4	CV3803	VS24K	CV3877	1B56
CV3729	1N47	CV3804	W21	CV3878	2-150D
CV3730	TMC15B	CV3805	W30K	CV3879	4-400A
CV3731	TMC16B	CV3806	W31	CV3880	4-1000A
CV3732	TMC20B	CV3808	6T4	CV3881	EB41
CV3733	3KP1	CV3809	807W	CV3882	EBC41
CV3734	6X5WGT	CV3810	WD30	CV3883	EAF42
CV3735	TP26	CV3812	1P31	CV3884	ECC40
CV3736	K1105P2	CV3813	8A	CV3885	EF40
CV3737	QK353	CV3815	3B22	CV3886	EF41
CV3738	VXR130	CV3816	X21	CV3887	EF42
CV3739	TX3-200	CV3817	X21	CV3888	ECH42
CV3740	TX5-400	CV3818	X22	CV3889	EL41
CV3741	TZ2-300	CV3819	X24	CV3890	EL42
CV3742	TZ20	CV3820	X24	CV3891	EZ40
CV3743	U5	CV3821	X31	CV3892	AZ41
CV3744	U6	CV3822	X31	CV3893	4X150G
CV3745	1B58	CV3823	X41	CV3894	6BF7
CV3746	U14	CV3824	X61	CV3895	5702
CV3747	U15	CV3825	X63	CV3896	5784
CV3748	2X2	CV3826	X65	CV3897	5787
CV3749	576	CV3827	12C8GT	CV3898	5829
CV3750	U22	CV3828	X66	CV3899	5932
CV3751	U21	CV3829	293A	CV3900	5963
CV3752	U30	CV3830	XH1.5	CV3901	6161
CV3753	U31	CV3831	XL2	CV3902	6002
CV3754	U50	CV3832	XP2	CV3903	QK338
CV3755	5755	CV3833	XSG2.0V	CV3904	2K41
CV3756	U600	CV3834	XW2	CV3905	5847
CV3758	UR3C	CV3835	Z21	CV3906	6117
CV3759	R2	CV3836	Z21	CV3907	720C
CV3760	UU5	CV3837	Z21	CV3908	6BH6
CV3761	UU7	CV3838	Z62	CV3909	6B.J6
CV3762	V120	CV3839	Z66	CV3912	1U5
CV3763	V123B	CV3840	TTR31MR	CV3915	8025A
CV3765	V226	CV3841	6F1	CV3916	5647
CV3766	V312	CV3842	5J29	CV3917	5703
CV3767	V339	CV3843	5J30	CV3918	5JP2A

SERVICE TYPE	COMMERCIAL EQUIVALENT	SERVICE TYPE	COMMERCIAL EQUIVALENT	SERVICE TYPE	COMMERCIAL EQUIVALENT
CV3919	U82	CV3992	HD6002	CV4069	F/6158
CV3920	A2196	CV3993	1N67A	CV4070	M8099
CV3921	A2244	CV3994	1V2	CV4073	SX641
CV3923	1N21B	CV3995	6CB6	CV4074	SX642
CV3924	6AC7W	CV3996	U709	CV4076	M8179
CV3925	TTR31MR	CV3997	JP9-15	CV42 <sup>n</sup> 7	SX643
CV3926	7C23	CV3998	6888	CV4078	SX644
CV3927	12K8	CV3999	MW22/22	CV4079	A2293
CV3928	5636	CV4001	F/6063	CV4080	M8225
CV3929	5840	CV4002	F/6064	CV4083	S6F33
CV3930	5718	CV4003	12AU7WA	CV4085	M8195
CV3931	5906	CV4004	6057	CV4097	S2P20
CV3932	5977	CV4005	6X4WA	CV4098	6AS6W
CV3933	5783	CV4006	6059	CV4100	0A2WA
CV3934	1N34A	CV4007	6AL5W	CV4101	0B2WA
CV3935	14A7	CV4008	6719	CV4104	M8163
CV3936	14S7	CV4009	6BA6W	CV4108	7308
CV3937	14R7	CV4010	5654	CV4116	UR45
CV3938	12CS7GT	CV4011	6AS6W	CV4121	UR40/F
CV3939	6BM6A	CV4012	5750	CV4501	7432
CV3940	2C39	CV4013	5670	CV4502	7433
CV3941	3RP1	CV4014	6064	CV4503	7434
CV3942	5692	CV4015	6065	CV4504	7435
CV3943	5852	CV4016	5814	CV4506	7436
CV3944	2J30	CV4017	5751	CV5001	601C
CV3945	2K45	CV4018	2D21W	CV5002	1N23B
CV3946	3WP1	CV4019	6AQ5W	CV5003	BU28/4
CV3947	4J54	CV4020	0A2WA	CV5004	3JP2
CV3948	4J55	CV4021	3B24WA	CV5005	6110
CV3949	4J56	CV4022	6135	CV5006	6021
CV3950	4J57	CV4023	6AU6WA	CV5007	6112
CV3951	4J58	CV4024	12AT7WA	CV5008	6080WA
CV3952	4J59	CV4025	6AL5	CV5009	6203
CV3953	7J78	CV4026	5R4WGA	CV5010	5644
CV3954	5CP7	CV4027	5Y3WGTA	CV5011	TH1657A
CV3955	5CP12	CV4028	0B2WA	CV5012	1N23C
CV3956	719A	CV4029	5902	CV5013	1N23CR
CV3957	1258	CV4030	G75/3G	CV5014	1N78
CV3958	5657	CV4031	6J6WA	CV5015	1N53
CV3959	5FP7A	CV4032	6814A	CV5016	1N32
CV3960	5783	CV4033	F/6060	CV5017	450TL
CV3961	6111	CV4034	F/6067	CV5018	JP9-80
CV3963	559	CV4035	F/6057	CV5019	QK387
CV3964	354	CV4036	F/8141	CV5020	QK388
CV3965	2C36	CV4037	F/5750	CV5021	6V3A
CV3966	QK428	CV4038	VX3208	CV5022	CS31A
CV3967	1N63	CV4039	6062	CV5023	AFX234
CV3968	3DP1A	CV4040	S6F17	CV5024	MX-408/U
CV3969	577	CV4041	S6F17F	CV5025	XB2
CV3970	5721	CV4042	S19G6F	CV5026	1N320
CV3971	89L	CV4043	6061	CV5027	XG1-2500
CV3972	6095	CV4044	6443	CV5028	3V/390B
CV3973	6AC7Y	CV4045	F/6061	CV5029	6J4WA
CV3974	6SA7Y	CV4046	44A/160M	CV5030	26Z5W
CV3975	6236	CV4047	G400/2G	CV5031	M548
CV3976	M509	CV4048	QS1212	CV5032	1X2A
CV3977	1N35	CV4049	F/5726	CV5033	3-14
CV3978	6AG7Y	CV4050	F/5654	CV5034	3JP11
CV3979	0D3W	CV4051	F/6158	CV5035	DG13-34
CV3980	12SR7GT	CV4052	QS1202	CV5036	6AF4
CV3981	G5S3	CV4053	QS1203	CV5037	6BA6W
CV3982	M506	CV4054	M8142	CV5038	6BC4
CV3983	12SW7GT	CV4055	6132	CV5039	6BL7
CV3984	1N21C	CV4056	F/6132	CV5040	6BQ6
CV3985	63L7VVG	CV4058	6C4WA	CV5041	6CL6
CV3986	6021	CV4059	M8097	CV5042	12BH7
CV3987	5644	CV4060	S11E12	CV5043	811A
CV3988	6442	CV4063	M8082	CV5044	5836
CV3989	6AN4	CV4064	S6F33-L5B/280D	CV5045	5837
CV3990	2E26	CV4066	M8190	CV5046	5844
CV3991	4X150D	CV4067	M8167	CV5047	G7B
		CV4068	6158	CV5048	V239C/1K

SERVICE TYPE	COMMERCIAL EQUIVALENT	SERVICE TYPE	COMMERCIAL EQUIVALENT	SERVICE TYPE	COMMERCIAL EQUIVALENT
CV5050	212-G11A	CV5140	EA52	CV6007	XH3-045
CV5051	HD2016A	CV5144	PCL83	CV6008	24B1
CV5052	6AU7	CV5156	EF89	CV6072	JP8-02B
CV5053	6098CT	CV5157	DP13-2	CV6087	LA9-3B
CV5054	6390	CV5168	5BKP1	CV6094	DM160
CV5055	EM81	CV5171	DP7-5	CV6095	3AFP31
CV5056	A2094	CV5172	DK92	CV6097	A2792
CV5057	5702WA	CV5173	90C1	CV6103	VS10H
CV5058	5784WA	CV5192	PCC84	CV6114	JPT9-02E
CV5059	5829WA	CV5214	E90CC	CV6122	QY3-65
CV5060	Z759	CV5215	ECF80	CV6123	QZ06-20
CV5061	7YP2	CV5219	CR1100	CV6131	C1149-1
CV5062	5841	CV5233	EL32	CV6135	G400/2G
CV5063	1N70	CV5234	XR1-1600A	CV6136	DDT527
CV5064	1N38A	CV5235	2J52	CV6137	4CX250B
CV5065	6U8	CV5239	TY7-6000A	CV6142	K391/A
CV5066	BL25	CV5244	MB13-1	CV6143	8D/03L3M
CV5067	6SH7L	CV5247	XH8-100	CV7018	ZR11
CV5068	ES75H	CV5249	KS9-30	CV7019	ZR12
CV5069	6621	CV5269	DG7-6	CV7020	ZR14
CV5070	5FP11	CV5277	ET51	CV7021	RS20
CV5071	3J/195E	CV5278	Z520M	CV7022	RS20
CV5072	EZ81	CV5281	ECC84	CV7023	RS20
CV5073	6AM4	CV5282	AL13-36	CV7024	RS20
CV5074	6AF4A	CV5290	VS10G	CV7025	RS20
CV5075	622C	CV5293	W7/3G	CV7036	GJ4M
CV5076	1N198	CV5300	AL22-10	CV7037	GJ6M
CV5077	PL81	CV5302	DH7-91	CV7038	GJ3M
CV5078	XC17	CV5304	6463	CV7040	0A202
CV5079	5643	CV5311	M8248	CV7041	0A95
CV5080	EF37A	CV5331	ECC189	CV7042	GT41
CV5081	61SPT	CV5354	E188CC	CV7045	1S111
CV5082	M8234	CV5358	ECC88	CV7046	1S115
CV5083	QS75-20	CV5365	6BQ7A	CV7048	0A5
CV5084	30B1P3	CV5369	4LP1	CV7129	0CP71
CV5085	27M2	CV5397	EC157	CV8279	NT2
CV5086	6BS7	CV5401	N1031	CV8563	CX1140
CV5087	4EP7	CV5402	N1032	CV873Q	TY6-5000B
CV5088	XC15	CV5412	DM160	CV8793	K3103
CV5089	L3040	CV5418	DG7-31	CV8973	4CX250B
CV5090	L3041	CV5425	10G-4	CV8978	RUTS0045
CV5092	EF800	CV5430	2C39A	CV9088	5702WB
CV5093	EL803	CV5434	EM84	CV9089	7203
CV5094	EL86	CV5443	JPG9-02C	CV9094	6528
CV5095	GK2261	CV5458	TD03-10E	CV9122	4CX250R
CV5096	GK2401	CV5472	6922	CV9167	ECL82
CV5098	ZS21	CV5473	6939	NGT1	DPQ
CV5099	ZS22	CV5724	E80T	NGT2	GT1C
CV5100	GJ3M	CV5745	GZ33	NGT4	GT1A
CV5101	GJ5M	CV5754	TD04-20A	NGT121	T41
CV5102	GJ6M	CV5760	5BKP7	NGT128	GT1C
CV5103	ZS20B	CV5766	E182CC	NR15	PM3
CV5104	GEX541	CV5793	5ADP2	NR15A	PM4DX
CV5105	0C45	CV5808	E55L	NR16	PM254
CV5106	E1T	CV5809	E810F	NR16A	PM4DX
CV5107	KD63	CV5810	EF814	NR18	DEQ
CV5108	EFP60	CV5811	5CLP31	NR22	PM14
CV5109	GE10	CV5820	Z700U	NR23	PM14
CV5112	3A/167M	CV5830	EL360	NR26	MHL4
CV5113	5787WA	CV5831	EF183	NR27	104V
CV5114	6260B	CV5847	QQV07-50	NR27A	104V
CV5115	X79	CV5883	3AZP2	NR28	PM2
CV5116	3B/241M	CV5900	KS7-85A	NR31	MH4
CV5120	20CV	CV5905	EY81	NR35	PD220A
CV5121	6870	CV5911	V271C/3M	NR37	ACSG
CV5122	Z900T	CV5940	DP4-1	NR38	VMS4
CV5123	JP9-15D	CV5956	TD03-10	NR39	PM22A
CV5125	DP13-34	CV5957	XR1-12	NR40	PM24D
CV5131	DG4-1	CV5959	QY4-400	NR41	210VPT
CV5132	M8163	CV5962	TD03-10D	NR42	P220
CV5134	2J51A	CV5989	E80CC	NR43	PM24A

SERVICE TYPE	COMMERCIAL EQUIVALENT	SERVICE TYPE	COMMERCIAL EQUIVALENT	SERVICE TYPE	COMMERCIAL EQUIVALENT
NR44	PX4	NU31	MU2	VR505	MH41
NR45	VMP4G	NU33	SU2150A	VS68	STV280/40
NR46	D41	NU33A	HVR2	VS69	STV280/80
NR47	PX25	NU34	HVR2	VS70	7475
NR48	EBC33	V177	EM31	VT1	203A
NR49	EF36	V1103	Y63	VT2	205B
NR50	AT4	VR18	2155G	VT4B/C	211
NR51	VMP4G	VR19	PM2	VT5	215A
NR52	354V	VR21	210LF	VT6	212A
NR53	KT42	VR22	220PA	VT7	WX12
NR54	AP4	VR27	210LF	VT8	UV204
NR54A	AP4	VR28	220VSG	VT17	860
NR55	4D1	VR32	220B	VT19	861
NR56	DA30	VR35	QP21	VT20	220P
NR57	ML4	VR37	MH4	VT22	204A
NR58	244V	VR38	MHL4	VT23	230XP
NR59	KT41	VR40	PX25	VT23A	230XP
NR60	H42	VR41	PM12M	VT24	864
NR61	W42	VR43	210PG	VT25	DET25
NR64	KTW62	VR44	210DDT	VT25A	10
NR65	MSP4	VR45	X56	VT26	22
NR66	D41	VR46	PT25H	VT27	30
NR67	6L7	VR47	TZ05-20	VT28	24
NR68	6Q7	VR49	210SPT	VT29	27
NR69	Y63	VR53	EF39	VT30	01A
NR70	MS/Pen	VR54	EB34	VT31	31
NR71	MS/PenT	VR55	EB3C3	VT33	33
NR72	N43	VR56	EF36	VT34	207
NR73	6N7	VR57	EK32	VT35	35/51
NR74	PV1-35	VR57A	EK32	VT36	36
NR75	ACP4	VR59	955	VT37	37
NR76	KTZ41	VR65	SP61	VT38	38
NR77	6L6	VR655A	SP41	VT39	869
NR78	6C5	VR66	P61	VT39A	869A
NR78A	L63	VR67	6J5	VT40	40
NR79	Z62	VR78	D1	VT41	851
NR80	E1148	VR82	220TH	VT42	872
NR81	6K7	VR83	210VPT	VT42A	872
NR82	X65	VR91	EF50	VT43	845
NR83	6J7	VR91A	EF50	VT44	32
NR84	20A1	VR92	EA50	VT45	X56
NR85	6F6	VR95	954	VT46	PT25H
NR86	KTW63	VR95A	954	VT46A	866A
NR87	AC5PenDD	VR99	X66	VT47	47
NR94	ACP4	VR99A	ECH35	VT48	41
NS1	STX280/80	VR100	KTW62	VT49	39/44
NS3	202	VR101	MHLD6	VT50	HL2
NS4	4713	VR102	BL63	VT51	Pen220A
NS5	304	VR105	ML6	VT52	EL32
NT18	D060	VR106	9D2	VT54	34
NT20	PM365	VR107	15D2	VT55	865
NT36	DA100	VR108	8D2	VT56	56
NT37	4033A	VR109	4D1	VT57	57
NT38A	PZ1-75	VR109A	4D1	VT58	58
NT39	ACT36	VR116	V872	VT60	807
NT40	DET5	VR117	41MTL	VT60A	807
NT58	DET12	VR117A	41MTL	VT61	DET19
NT62	PM24D	VR118	KT2	VT61A	TV03-10
NT62A	PM24D	VR119	DDL4	VT62	TY1-50
NT65A	PZ1-35	VR122	41MXP	VT63	42
NT82	PM202	VR123	EF8	VT64	800
NU3	U12/14	VR124	MS/Pen	VT65	6C5
NU5	RX3-120	VR125	MS/PenB	VT65A	6C5G
NU12	U18	VR126	4SH	VT66	6F6
NU13	IJ15	VR129	MS/Pen	VT66A	6F6G
NU13A	U15	VR130	HL23	VT67	30
NU15	U4020	VR135	E1148	VT68	6B7
NU16	GU5	VR136	EF54	VT69	6D6
NU17	UU5	VR137	EC52	VT70	6F7
NU18	U17	VR502	KT32	VT72	842
NU20	U50	VR508	KT33C	VT73	6F5

SERVICE TYPE	COMMERCIAL EQUIVALENT	SERVICE TYPE	COMMERCIAL EQUIVALENT	SERVICE TYPE	COMMERCIAL EQUIVALENT
VT74	6J7	VT126A	6X5G	VT196	6W5
VT75	KT66	VT126B	6X5GT	VT197A	5Y3G
VT75AB	KT44	VT127	Pen46	VT198A	6G6
VT76	DA41	VT128	1630	VT199	6SS7
VT77	77	VT129	304TL	VT200	VR105-30
VT78	78	VT130	250TL	VT201	25L6
VT79	KT8	VT131	12SK7	VT201C	25L6GT
VT80	4307A	VT132	12K8	VT202	9006
VT81	4052A	VT133	12SR7	VT203	9003
VT83	83	VT134	12A6	VT204	HK24G
VT84	84/6Z4	VT135	12J5	VT205	6ST7
VT85	6K7	VT135A	12J5	VT206A	5V4G
VT86	6K7	VT136	1625	VT207	12AH7
VT86A	6K7G	VT137	1626	VT208	7B8
VT86B	6K7GT	VT138	1629	VT209	12SG7
VT87	6L7	VT139	MH4	VT210	1S4
VT87A	6L7G	VT140	1628	VT211	6SG7
VT88	832	VT141	531	VT212	958
VT88A	6R7G	VT142	WE39DY	VT213A	6L5
VT88B	6RTGT	VT143	805	VT214	12H6
VT89	89	VT144	813	VT215	6E5
VT90	6H6	VT145	5Z3	VT216	816
VT90A	6H6GT	VT146	1N5GT	VT217	811
VT91	6J7	VT147	1A7	VT218	100TH
VT91A	6J7GT	VT148	1D8	VT220	250TH
VT92	6Q7	VT149	3A8	VT221	305
VT92A	6Q7G	VT150	6SA7	VT222	884
VT93	6B8	VT150A	6SA7GT	VT223	1H5
VT93A	6B8G	VT151	6A8	VT224	RK34
VT94	6J5	VT151A	6A8GT	VT225	307A
VT94A	6J5G	VT152	6K6	VT226	3EP1/1806P1
VT94B	6J5	VT152A	6K6GT	VT227	7184
VT94C	6J5	VT153	12C8	VT228	8012
VT94D	6J5GT	VT154	814	VT229	6SL7
VT95	2A3	VT158	3092	VT230	350A
VT96	5B/502A	VT161	12SA7	VT231	6SN7
VT96B	6N7	VT162	12SJ7	VT232	E1148
VT97	5W4	VT163	6C8	VT233	6SR7
VT98	6U5/6G5	VT164	1619	VT234	114B
VT99	6F8	VT165	1624	VT235	615
VT100	807	VT166	371A	VT236	836
VT100A	807	VT167	6K8	VT237	957
VT101	837	VT167A	6K8GT	VT238	956
VT103	6SQ7	VT168A	6Y6	VT239	1LE3
VT104	PT15	VT169	12C8	VT240	710A
VT105	ML6	VT170	1E5GP	VT241	7E5
VT106	803	VT171	1R5	VT243	7C4
VT107	6V6	VT171A	1R5	VT244	5U4
VT107A	6V6GT	VT172	1S5	VT245	2050
VT107B	6V6G	VT173	1T4	VT246	918
VT108	450TH	VT174	3S5	VT247	6AG7
VT109	2051	VT175	1613	VT248	3CP1/180P1
VT111	5BP4/1802P4	VT176	6AB7	VT249	1006
VT112	6AC7	VT177	1LH4	VT250	EF50
VT114	5T4	VT178	1LC5	VT251	WL441
VT115	6L6	VT179	1LN5	VT252	923
VT115A	6L6GT	VT180	EF39	VT254	304TH
VT116	6SL7	VT181	7Z4	VT255	705A
VT116A	6SJ7GT	VT182	3B7	VT256	GL486
VT116B	6SJ7Y	VT183	1R4	VT257	K-7
VT117	6SK7	VT184	VR90/30	VT259	829
VT117A	6SK7GT	VT185	3D6	VT260	0A3
VT118	832	VT187	575A	VT264	3Q4
VT119	2X2	VT188	7E6	VT266	1616
VT120	954	VT189	7F7	VT267	WL578
VT121	955	VT190	7H7	VT268	12SC7
VT122	530	VT191	316A	VT269	717A
VT123	5586	VT192	7A4	VT277	417
VT124	1A5	VT193	7C7	VT279	GY2
VT125	1C5	VT194	7J7	VT280	C7063
VT126	6X5	VT195	5Z4G	VT281	HY145ZT



SERVICE TYPE	COMMERCIAL EQUIVALENT
--------------	-----------------------

VT282	ZG489
VT283	QF-206
VT284	QF-197
VT285	QF-200C
VT286	832A
VT287	815
VT288	12SH7
VT289	12SL7
VT501	E1192

SERVICE TYPE	COMMERCIAL EQUIVALENT
--------------	-----------------------

VT501A	E1192
VU29	ESU150
VU39	MU12/14
VU64	U12/14
VU71	U52
VU71A	U52
VU72	GU5
VU111	V1907
VU113	U17

SERVICE TYPE	COMMERCIAL EQUIVALENT
--------------	-----------------------

VU120	SU2150A
VU120A	SU2150A
VU133	V960
VU134	HVR2
VU504	V1901
VU508	V1913
VW36	220PA
VW42	210LF
VW48	2155G

**INTENTIONALLY LEFT BLANK**

## AMERICAN ARMY V.T. SERIES TO COMMERCIAL TYPES

SERVICE TYPE	COMMERCIAL EQUIVALENT	SERVICE TYPE	COMMERCIAL EQUIVALENT	SERVICE TYPE	COMMERCIAL EQUIVALENT
VT1	203A	VT85	6K7	VT136	1625
VT2	205B	VT86	6K7	VT137	1626
VT4B/C	211	VT86A	6K7G	VT138	1629
VT5	215A	VT86B	6K7GT	VT139	VR150-30
VT6	212A	VT87	6L7	VT140	1628
VT7	WX12	VT87A	6L7G	VT141	531
VT8	UV204	VT88	6R7	VT142	WE39DY
VT17	860	VT88A	6R7G	VT143	805
VT19	861	VT88B	6RTGT	VT144	813
VT22	204A	VT89	89	VT145	5Z3
VT24	864	VT90	6H6	VT146	1N5GT
VT25	10	VT90A	6H6GT	VT147	1A7
VT25A	10	VT91	6J7	VT148	1D8
VT26	22	VT91A	6J7GT	VT149	3A8
VT28	24	VT92A	6Q7G	VT150A	6SA7GT
VT29	27	VT93	6B8	VT151	6A8
VT30	01A	VT93A	6B8G	VT151A	6A8GT
VT31	31	VT94	6J5	VT152	6K6
VT33	33	VT94A	6J5G	VT152A	6K6GT
VT34	207	VT94B	6J5	VT153	12C8
VT35	35/51	VT94C	6J5	VT154	814
VT36	36	VT94D	6J5GT	VT158	3092
VT37	37	VT95	2A3	VT161	12SA7
VT38	38	VT96	6N7	VT162	12SJ7
VT39	869	VT96B	6N7	VT163	6C8
VT39A	869A	VT97	5W4	VT164	1619
VT40	40	VT98	6U5/6G5	VT165	1624
VT41	851	VT99	6F8	VT166	371A
VT42	872	VT100	807	VT167	6K8
VT42A	872	VT100A	807	VT167A	6K8GT
VT43	845	VT101	837	VT168A	6Y6
VT44	32	VT103	6SQ7	VT169	12C8
VT45	45	VT104	12SQ7	VT170	1E5GP
VT46	866	VT105	6SC7	VT171	1R5
VT46A	866A	VT106	803	VT171A	1R5
VT47	47	VT107	6V6	VT172	1S5
VT48	41	VT108	450TH	VT173	1T4
VT49	39/44	VT109	2051	VT174	3S5
VT50	50	VT111	5BP4/1802P4	VT175	1613
VT51	841	VT112	6AC7	VT176	6AB7
VT52	2C45	VT114	5T4	VT177	1LH4
VT54	34	VT115	6L6	VT178	1LC5
VT55	865	VT115A	6L6GT	VT179	1LN5
VT56	56	VT116	6SL7	VT180	3LF4
VT57	57	VT116A	6SJ7GT	VT181	7Z4
VT58	58	VT116B	6SJ7Y	VT182	3B7
VT60	850	VT117	6SK7	VT183	1R4
VT62	801	VT117A	6SK7GT	VT184	VR90/30
VT63	42	VT118	832	VT185	3D6
VT64	800	VT119	2X2	VT187	575A
VT65	6C5	VT120	954	VT188	7E6
VT65A	6C5G	VT121	955	VT189	7F7
VT66	6F6	VT122	530	VT190	7H7
VT66A	6F6G	VT123	5586	VT191	316A
VT67	30	VT124	1A5	VT192	7A4
VT68	6B7	VT125	1C5	VT193	7C7
VT69	6D6	VT126	6X5	VT194	7J7
VT70	6F7	VT126A	6X5G	VT195	1005
VT72	842	VT126B	6X5GT	VT196	6W5
VT73	843	VT128	1630	VT197A	5Y3G
VT74	5Z4	VT129	304TL	VT198A	6G6
VT75	75	VT130	250TL	VT199	6SS7
VT76	76	VT131	12SK7	VT200	VR 105-30
VT77	77	VT132	12K8	VT201	25L6
VT78	78	VT133	12SR7	VT201C	25L6GT
VT80	80	VT134	12A6	VT202	9006
VT83	83	VT135	12J5	VT203	9003
VT84	84/6Z4	VT135A	12J5	VT204	HK24G

SERVICE TYPE	COMMERCIAL EQUIVALENT
--------------	-----------------------

VT205	6ST7
VT206A	5V4G
VT207	12AH7
VT208	7B8
VT209	12SG7
VT210	1S4
VT211	6SG7
VT212	958
VT213A	6L5
VT214	12H6
VT215	6E5
VT216	816
VT217	811
VT218	100TH
VT220	250TH
VT221	305
VT222	884
VT223	1H5
VT224	RK34
VT225	307A
VT226	3EP1/1806P1
VT227	7184
VT228	8012

SERVICE TYPE	COMMERCIAL EQUIVALENT
--------------	-----------------------

VT229	6SL7
VT230	350A
VT231	6SN7
VT232	E1148
VT233	6SR7
VT234	114B
VT235	615
VT236	836
VT237	957
VT238	956
VT239	1LE3
VT240	710A
VT241	7E5
VT243	7C4
VT244	5U4
VT245	2050
VT246	918
VT247	6AG7
VT248	3CP1/180P1
VT249	1006
VT250	EF50
VT251	WL441
VT252	923

SERVICE TYPE	COMMERCIAL EQUIVALENT
--------------	-----------------------

VT254	304TH
VT255	705A
VT256	GL486
VT257	K-7
VT259	829
VT260	0A3
VT264	3Q4
VT266	1616
VT267	WL578
VT268	12SC7
VT269	717A
VT277	417
VT279	GY2
VT280	C7063
VT281	HY145ZT
VT282	ZG489
VT283	QF-206
VT284	QF-197
VT285	QF-200C
VT286	832A
VT287	815
VT288	12SH7
VT289	12SL7

**British Post Office VT Series, British Service Types & Commercial Equivalents**

BRITISH P.O.TYPE	SERVICES TYPE	COMMERCIAL EQUIVALENT	BRITISH P.O.TYPE	SERVICES TYPE	COMMERCIAL EQUIVALENT
VT10	CV1610	MT4	VT109	CV1677	AC52
VT11	CV1611	MR4	VT110	CV1678	HLA2
VT16	CV1607	OC25	VT111	CV1679	DA30
VT17	CV1608	U4	VT112	CV1680	PM202
VT19	CV1612	VT9B	VT113	CV1681	TSP4
VT20	CV1613		VT114	CV1682	
VT24	CV1636	LS5	VT115	CV1683	MKT4
VT25	CV1637	LS5	VT116	CV1684	APP4C
VT26	CV1600	CAT1	VT116A	CV1685	APP4C
VT27	CV1601	CAR1	VT118A	CV1686	D418
VT31	CV1638	4101D	VT118b	CV1687	D418
VT32B	CV1640	4002D	VT119	CV1169	VMP4G
VT32D	CV1641	4102E	VT120	CV1688	3B/252B
VT33	CV1642	DER	VT121A	CV1288	3B/252B
VT34	CV1614	ES1500A	VT125	CV1689	PA1
VT36	CV1602	CAR4	VT126	CV1690	9A1
VT37B	CV1643	E132	VT127	CV1187	D41
VT37C	CV1644	E1532	VT127A	CV1691	DDL4
VT38	CV1645	E133	VT128	CV1692	AC/P
VT38A	CV1646	E1453	VT130	CV1621	ESW501
VT40	CV1647	LS5B	VT131	CV1168	PX4
VT46	CV1616		VT132	CV1694	3A/144A
VT47	CV1603	4104A	VT133	CV1695	DH30
VT51	CV1617		VT136	CV1118	KT2
VT52	CV1025	DET25	VT137	CV1081	4502A
VT53	CV1604	SSI971	VT138	CV1623	RG1-250
VT54	CV1618	ES250M	VT139	CV399	MH4
VT56	CV1648	4205E	VT140	CV1166	P220
VT57	CV25	ES85	VT142	CV1039	R3
VT58	CV1619	4212E	VT143	CV1696	B21
VT59	CV1620	DET6	VT144	CV1371	PZ1-35
VT60	CV1605	4013C	VT145	CV243	4045A
VT61	CV1609	SW7	VT146	CV1625	RG30250
VT62	CV1606	CAT7	VT147	CV1697	X41
VT65	CV1649	6C5	VT148	CV1689	A819
VT66	CV1650	LS5A	VT149	CV1349	RG5-500
VT68	CV1651	G455B	VT150	CV1699	SP41
VT69	CV1652	P220A	VT150A	CV1700	SP41
VT72	CV249	4019A	VT151	CV1701	XLO
VT73A	CV1653	KC1	VT152	CV1702	XP
VT74	CV1654		VT153	CV1703	XW
VT75	CV1655	4109B	VT154	CV1067	6J5
VT78	CV1656	LS8	VT155	CV1704	57
VT79A	CV1657	4020B	VT156	CV1705	58
VT80A	CV1658	L29B	VT157	CV1706	2B7
VT81	CV1659	4022B	VT158	CV1707	2A5
VT82	CV1660	LS7	VT159	CV1708	80
VT85	CV1661	DL	VT160	CV1709	6D6
VT86	CV1662	P215	VT161	CV1710	6C6
VT87	CV1663	4021B	VT162	CV1711	6B7
VT88	CV1664	B406	VT163	CV1712	42
VT89	CV1665	DH	VT164	CV1713	EF8
VT90	CV1732	ML4	VT165	CV1714	1F9
VT91	CV1038	MHL4	VT166	CV1715	EBC3
VT92	CV1735	DC2P	VT167	CV1716	E1541
VT93	CV1666	P610	VT168	CV1626	RG10240A
VT94	CV1667	LS8A	VT169	CV1717	4307A
VT95	CV1668	4033L	VT170	CV1718	AC/TP
VT98	CV1669	P625	VT171	CV1719	U22
VT100	CV1670	HL1320	VT177	CV1720	XL15
VT100B	CV1670	HL1320	VT178	CV1721	XP15
VT102	CV1671	4021A	VT179	CV1722	A901
VT103B	CV1672	Pen36C	VT180	CV1053	EF39
VT105	CV1673	PM2HL	VT181	CV1052	EL32
VT106	CV1674	AC/S2Pen	VT182	CV1823	1N5
VT107	CV1675	N43	VT183	CV1724	5A/102D
VT108	CV1676	LS8A	VT185	CV245	4328D

BRITISH P.O.TYPE	SERVICES TYPE	COMMERCIAL EQUIVALENT
VT186	CV1726	5A/105A
VT187	CV1627	5D/100A
VT188	CV1727	Z22
VT189	CV1128	GT1C
VT190	CV1728	WE262B
VT191	CV1628	GU8
VT193	CV1100	KTW61
VT194	CV587	6Q7
VT195	CV1863	5Z4
VT196	CV509	6V6
VT197	CV1629	RG3-1250A

BRITISH P.O.TYPE	SERVICES TYPE	COMMERCIAL EQUIVALENT
VT198	CV1075	KT66
VT199	CV124	807
VT200	CV1065	SP61
VT201	CV1056	EF36
VT202	CV1054	EB34
VT203	CV9	AL60
VT204	CV18	DET19
VT205	CV1630	ESP450
VT206	CV1120	SU2150A
VT207	CV1091	EF50

### B.V.A. UTILITY EQUIVALENTS (World War 2)

The last figure of this number denotes the manufacturer and can be disregarded  
E.g., all the 260 series are equivalent to an EL33

B.V.A. No.	CIVILIAN No.	B.V.A. No.	CIVILIAN No.	B.V.A. No.	CIVILIAN No.
172	TP25	132	HL23DD	264	EL33
211	DW4/350	142	VP23	274	ECH35
243	EF29	162	Pen25		

**INTENTIONALLY LEFT BLANK**



Avo Limited.  
Archcliffe Road, Dover.  
Kent CT17 9EN, England.  
Tel: Dover (0304) 202620 Telex

A Member of the  
THORN EMI Group

